

12 Discrete Input, 8 Relay Output Controller with SAE J1939

USER MANUAL

P/N: AX031800 and AX031850 (250kbps)

AX031800-01 and AX031850-01 (500kbps)

AX031800-02 and AX031850-02 (1Mbps)

ACRONYMS

ACK	Positive Acknowledgement
CSR	CAN Status Report
DIO	Discrete-Input-Output
DM	Diagnostic Message (from SAE J1939 standard)
DTC	Diagnostic Trouble Code
FMI	Failure Mode Identifier
OC	Occurrence Count
EA	Axiomatic Electronic Assistant (Service Tool for Axiomatic ECUs)
ECU	Electronic Control Unit (from SAE J1939 standard)
MAP	Memory Access Protocol
NAK	Negative Acknowledgement
PDU1	A format for messages that are to be sent to a destination address, either specific or global
PDU2	A format used to send information that has been labeled using the Group Extension technique and does not contain a destination address.
PGN	Parameter Group Number (from SAE J1939 standard)
PropB	Message that uses a Proprietary B PGN
SPN	Suspect Parameter Number (from SAE J1939 standard)

Note:

An Axiomatic Electronic Assistant KIT may be ordered as P/N: AX070502 or AX070506K

TABLE OF CONTENTS

1. GENERAL INFORMATION	5
1.1. INTRODUCTION TO FEATURES	5
1.2. J1939 NETWORK – DIAGNOSTIC BROADCAST	6
1.3. DIGITAL INPUT FUNCTION BLOCKS	6
1.3.1. Digital Input Functionality	6
1.3.2. Debounce Time	6
1.3.3. Digital Input Type	7
1.3.4. Digital Input Diagnostic Trouble Code Trigger	7
1.4. RELAY OUTPUT FUNCTION BLOCKS	9
1.4.1. Relay Output Functionality	9
1.4.2. Relay Output Control/Enable/Override/Unlatch Sources	10
1.4.3. Relay Output Enable	10
1.4.4. Relay Output Override	11
1.4.5. Unlatch Source	12
1.4.6. Digital Output Diagnostic Trouble Code Trigger	12
1.5. DIAGNOSTICS	12
1.5.1. General Diagnostics	12
1.5.2. Power Supply – Temperature – CAN - Diagnostics	12
1.5.3. Diagnostic Trouble Code (DTC) React	13
1.6. LED CONTROL	14
1.6.1. LED Control Sources	14
1.6.2. LED Output/Response Type	14
1.7. CAN RECEIVE FUNCTION BLOCK	15
1.8. CAN TRANSMIT FUNCTION BLOCK	16
1.9. CAN STATUS REPORTS	17
1.10. CONDITIONAL BLOCK	18
2. OVERVIEW OF J1939 FEATURES	19
2.1. INTRODUCTION TO SUPPORTED MESSAGES	20
2.2. J1939 NAME, ADDRESS AND SOFTWARE ID	21
2.2.1. J1939 Name	21
2.2.2. ECU Address	21
2.2.3. Software Identifier	22
2.3. CAN TRANSMIT MESSAGE DEFAULT	23
3. ECU SETPOINTS ACCESSED WITH THE AXIOMATIC ELECTRONIC ASSISTANT	24
3.1. J1939 NETWORK SETPOINTS	24
3.2. LED CONTROL SETPOINTS	24
3.3. DIGITAL INPUT SETPOINTS	26
3.4. RELAY OUTPUT SETPOINTS	26
3.5. CONDITIONAL BLOCK	28
3.6. CONSTANT DATA LIST SETPOINTS	29
3.7. CAN STATUS REPORT SETPOINTS	30
3.8. CAN TRANSMIT SETPOINTS	32
3.9. CAN RECEIVE SETPOINTS	33
3.10. DTC REACT SETPOINTS	34
3.11. POWER SUPPLY DIAGNOSTICS	34
3.12. TEMPERATURE DIAGNOSTICS	35
3.13. CAN DIAGNOSTICS	36
3.14. GENERAL DIAGNOSTICS	37
4. REFLASHING OVER CAN WITH THE AXIOMATIC ELECTRONIC ASSISTANT BOOTLOADER	39
4.1. PREREQUISITES	39
4.2. RE-FLASHING PROCEDURE	39

- 5. INSTALLATION INSTRUCTIONS 43
 - 5.1. DIMENSIONS AND PINOUT FOR AX031800..... 43
 - 5.2. DIMENSIONS AND PINOUT FOR AX031850..... 45
 - 5.3. INSTALLATION INSTRUCTIONS 46
- 6. TECHNICAL SPECIFICATIONS..... 49

1. GENERAL INFORMATION

1.1. Introduction to Features

The Discrete Input-Output controller (DIO) is designed to provide a simple interface between J1939 CAN network and discrete electronic devices in a power generator set or industrial environment. The hardware of the DIO supports 12 discrete inputs and 8 normally-open/normally-closed relay outputs.

The DIO is a versatile controller with several setpoints that will allow the user to configure it according to their application. The tool used to configure the unit is the Axiomatic Electronic Assistant. The Axiomatic EA communicates with the DIO over the J1939 CAN bus and uses Memory Access Protocol (MAP) to read/write each setpoint. Once the DIO has been setup as desired, the setpoints can be saved to a file, and flashed into other DIOs over the CAN bus using the Axiomatic EA.

Depending on how the controller is configured, the DIO can have its relay outputs respond to Diagnostic Trouble Codes, J1939 CAN messages, discrete inputs, or have them all disabled.

The DIO is an arbitrary address capable ECU, which can perform dynamic address allocation at the run time. It also provides all necessary network support required by the J1939 standard.

A front panel bi-colour LED indicator allows the user to observe the current state of DIO and easily identify a normal operating condition and situations when there is a network error or absence of network traffic.

If an error, power glitch or other emergency cases occurs on the network, the DIO will self-recover immediately after the normal condition is restored.

1.2. J1939 Network – Diagnostic Broadcast

The DIO broadcasts diagnostic messages, which are triggered by the internal function blocks onto the CAN bus network. However, in some applications this broadcast may not be required and so the DIO gives the user the option to disable or enable this feature. Section 3.1 and 3.14 shows the configuration of this feature by using the Axiomatic Electronic Assistant tool.

1.3. Digital Input Function Blocks

The 12 digital inputs of the DIO controller have a fixed 5kOhm pull-up resistor. The signals going into the DIO controller are interpreted as 0 or 1. The turn ON-signal (1) is reached at 3.75V input level while the turn OFF-signal (0) is reached at 0.8V input level. The discrete inputs can be used as control sources for relay outputs and/or can be used to trigger Diagnostic Trouble Codes in the J1939 network.

The sub sections below explain in more detail the functionality and available setpoints/parameters of the discrete inputs.

1.3.1. Digital Input Functionality

The Active High/Low parameter allows the user to select how the controller responds to the behaviour of the digital input. Table 1 shows the different Active High/Low options with the default being highlighted.

Table 1: Active High/Low

Value	Meaning
0	Active High
1	Active Low

The inputs of the DIO have a fixed 5kOhm pull-up resistor. Given that by default, the inputs are configured to *Active High*, an ON response by the DIO is achieved when the input is grounded.

1.3.2. Debounce Time

The Digital Input Debounce Time parameter is a useful parameter in cases where the digital input signal coming in to the controller is noisy. Figure 1 shows how the Debounce Time helps detect a correct input signal.

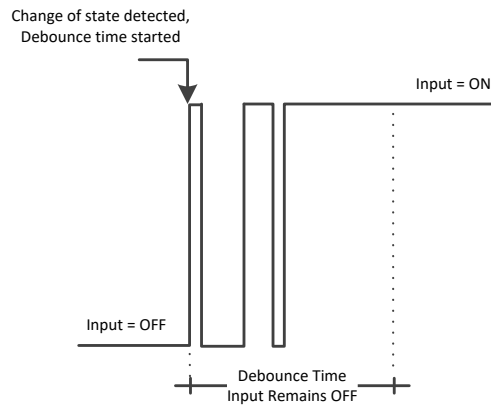

Figure 1: Digital Input Debounce Time

1.3.3. Digital Input Type

The Digital Input Type parameter allows for flexibility in the response of the input. Table 2 shows the options available for this parameter.

Table 2 Digital Input Types

Value	Meaning
0	Normal Logic
1	Inverse Logic
2	Latched Logic

By default, the *Normal Logic* type is used for the digital input.

In *Normal Logic* mode, the input state is 1 in case the input signal is interpreted as an ON-signal. The input state turns 0 if the input signal is interpreted as an OFF-signal.

For the *Inverse Logic* type, the opposite behavior applies. If the input signal is ON, the state turns 0 and if the input signal is OFF, the state turns 1.

Setting the Input to *Latched Logic*, the input state is toggled between 1 and 0 every time the input signal of the respective digital input changes from OFF to ON.

1.3.4. Digital Input Diagnostic Trouble Code Trigger

The DIO controller allows for Diagnostic Trouble Codes (DTCs) to be sent by the DIO controller on the J1939 network upon an ON-signal detection.

Event Generates a DTC in DM1 parameter determines whether or not a configured DTC is sent on the network upon an ON-signal detection. Table 3 shows the different options for this parameter.

Table 3: Event Generates a DTC in DM1

Value	Meaning
0	<i>False</i>
1	<i>True</i>

By default, no digital input sends a DTC on the network when an ON signal is detected. If **Event Generates a DTC in DM1** is set to *TRUE*, the user has access to a full configuration of the DTC parameters. When **Event Cleared Only by DM11** parameter is set to *FALSE*, the DTC is cleared when the controller no longer detects an ON signal at its respective digital input. However, when **Event Cleared Only by DM11** is *TRUE*, the DTC will remain active after the controller no longer detects an ON signal at its respective digital input until a DM11 message is sent to the controller. Upon reception of a DM11 message, if the controller is detecting an ON signal at its respective digital input, the DTC **will not** be cleared. If, however, the controller no longer detects an ON signal at its respective digital input upon reception of a DM11 message, the DTC will be cleared but the occurrence count **will** remain the same. If desired to clear the occurrence count, it is necessary for a DM3 message to be sent to the controller.

Table 4 shows the available options for **Lamp Set by Event in DM1** that can be configured.

Table 4: Lamp Set by Event in DM11

Value	Meaning
0	<i>Protect</i>
1	<i>Amber, Warning</i>
2	<i>Red, Stop</i>
3	<i>Malfunction</i>

Table 5 below shows the available options for the **Failure Mode Identifiers** (FMI) used in the DTC.

Table 5: FMI for Event used in DTC

Value	Meaning
0	<i>Data Valid But Above Normal Operational Range - Most Severe Level</i>
1	<i>Data Valid But Below Normal Operational Range - Most Severe Level</i>
2	<i>Data Intermittent</i>
3	<i>Voltage Above Normal, Or Shorted To High Source</i>
4	<i>Voltage Below Normal, Or Shorted To Low Source</i>
5	<i>Current Below Normal Or Open Circuit</i>
6	<i>Current Above Normal Or Grounded Circuit</i>
7	<i>Mechanical Error</i>
8	<i>Abnormal Frequency Or Pulse Width Or Period</i>
9	<i>Abnormal Update Rate</i>
10	<i>Abnormal Rate Of Change</i>
11	<i>Root Cause Not Known</i>
12	<i>Bad Component</i>
13	<i>Out Of Calibration</i>
14	<i>Special Instructions</i>
15	<i>Data Valid But Above Normal Operating Range – Least Severe Level</i>

16	<i>Data Valid But Above Normal Operating Range – Moderately Severe Level</i>
17	<i>Data Valid But Below Normal Operating Range – Least Severe Level</i>
18	<i>Data Valid But Below Normal Operating Range – Moderately Severe Level</i>
19	<i>Network Error</i>
20	<i>Data Drifted High</i>
21	<i>Data Drifted Low</i>
31	<i>Condition Exists</i>

When the DIO controller has detected an ON signal at the digital input, which has been configured to send a DTC, the parameter **Delay Before Sending DM1** determines how long the controller will wait in milliseconds before sending a DTC in a DM1 message. If the digital input has turned OFF before **Delay Before Sending DM1** the DTC will not become active and will not be sent on the network. If the controller is sending a DM1 message and the state of the digital input turns OFF, the error will be cleared after the configured time in milliseconds of the parameter **Delay Before Clearing DM1**.

1.4. Relay Output Function Blocks

There are 8 relay outputs available in the DIO controller which are 2Amp rated. The following sub sections will explain in more detail the functionalities and available setpoints/parameters.

1.4.1. Relay Output Functionality

All 8 relay outputs have 2 states: *Normally Open* and *Normally Closed*. Each relay output has 3 pins associated with it: Normally Closed (NC), Normally Open (NO), and Common (C). The **Relay Output Type** parameter allows for flexibility in the response of the output. Table 6 shows the options available for this parameter.

Table 6: Relay Output Type

Value	Meaning
0	<i>Output Not Implemented</i>
1	Normal Logic
2	<i>Inverse Logic</i>
3	<i>Latched Logic</i>
4	<i>Inverse Latched Logic</i>
5	<i>Toggle Logic</i>

By default, *Normal Logic* response is used for the relay outputs.

In *Normal Logic* response, the Common pin is connected to the Normally Closed pin if the source of the respective relay output is triggered ON, the Common pin is connected to the Normally Open pin.

In the case of *Inverse Logic* response, the Common pin is connected to the Normally Open pin when the source of the respective relay output is triggered ON. When the source of the respective relay output is triggered OFF, the Common pin is connected to the Normally Closed pin.

In the case of *Latched Logic* response, the Common pin is toggled between Normally Closed and Normally Open pins every time the source of the respective relay output goes from OFF to ON. The opposite behavior applies for the *Inverse Latched Logic*. If the output switches from ON to OFF, the output state changes.

The *Toggle Logic* let the relay output toggle between Normally closed and Normally Open pins for a configured frequency. The time for switching from one state to the other state results the **Toggle Frequency** which is in milliseconds and by default 500ms.

1.4.2. Relay Output Control/Enable/Override/Unlatch Sources

The relay outputs can be configured to be commanded and/or enabled by the control sources listed in Table 7. This table also displays the number associated to the control sources which can be selected. The default control source is highlighted in Table 7 while the default Enable Source and Override Source is configured to *Source Not Used*.

Table 7: Relay Output Control/Enable/Override/Unlatch Source

Value	Meaning	Source Range
0	<i>Source Not Used</i>	[0]
1	<i>Digital Input</i>	[1...12]
2	<i>Digital Relay Output</i>	[1...8]
3	<i>Power Supply Voltage Fault State</i>	[0]
4	<i>Temperature Fault State</i>	[0]
5	<i>Diagnostic Trouble Code</i>	[1...30]
6	<i>CAN Receive Message</i>	[1...10]
7	<i>Conditional Block</i>	[1...10]

The selected control source in the **Control Source** parameter is the main commanding source of the relay output based on **Relay Output Type** parameter. A delay can be set for both output states. In case the output state should turn low after a certain amount of time, the parameter **Turn OFF Delay** can be set. Whereas the **Turn ON Delay** can be configured to set a delay before switching from the OFF-state to ON-state. Both delays are configurable in milliseconds.

1.4.3. Relay Output Enable

The **Enable Source** will determine whether or not the relay output will be commanded by the **Control Source**. There are six different **Enable Responses** in which the enable signal can be used. These responses are listed in Table 8, where the default value is highlighted.

Table 8: Enable Response

Value	Meaning
0	<i>Enable When ON</i>
1	<i>Enable When OFF</i>
2	<i>Disable When ON</i>
3	<i>Disable When OFF</i>

4	<i>Enable When ON Else Keep State</i>
5	<i>Enable When OFF Else Keep State</i>

When the **Enable Response** is set to *Enable When ON* or *Disable When OFF*, the relay output will be commanded according to the signal of the **Control Source/Number** and the **Relay Output Type** only when the signal of the **Enable Source/Number** is ON. Otherwise, the relay output is commanded to the OFF state (**Relay Output Type** selected).

Similarly, when the **Enable Response** is set to *Enable When OFF* or *Disable When ON*, the relay output will be commanded according to the **Control Source/Control Number** and the **Relay Output Type** only when the signal of the **Enable Source/Enable Number** is OFF. Otherwise, the relay output is commanded to the OFF state (**Relay Output Type** selected).

In case the **Enable Response** is *Enable When ON Else Keep State*, the relay output will be commanded according to the signal of the **Control Source/Number** and the **Relay Output Type** only when the signal of the **Enable Source/Number** is ON. If the Enable Source is OFF, the relay output will keep the previous state.

Likewise, when the **Enable Response** is configured to *Enable When OFF Else Keep State*, the relay output will be commanded according to the **Control Source/Number** and the Relay Output Type only when the **Enable Source/Number** is OFF. Otherwise, the relay output holds the previous state.

A time delay for both states (ON, OFF) can be set by setting the **Enable Response Delay** parameter to true. The values of these time delays can be set with the parameters **Turn OFF Delay** and **Turn ON Delay**. In this case, the delays are valid for the enable state and the control state.

1.4.4. Relay Output Override

The **Override Source** will determine whether or not the relay output will be commanded by the **Control Source**. This Source has a higher priority than the Enable Source.

There are two different **Override Responses** in which the Override signal can be used. These responses are listed in Table 9, where the default value is highlighted.

Table 9: Override Responses

Value	Meaning
0	Override When OFF
1	Override When ON

When the **Override Response** is configured to *Override When ON*, the relay output will be commanded according to the signal of the **Control Source/Number** by the **Override State**. If the Override Response is set to *Override When OFF*, the relay output will be commanded according to the signal of the Control Source/Number by the Override State. Table 10 shows the two possible states for the **Override Response**.

Table 10: Override State

Value	Meaning
0	Override State OFF
1	Override State ON

In case of **Override State OFF**, the relay output switches to Normally Open. If **Override State ON** is configured, the relay output changes to Normally closed.

1.4.5. Unlatch Source

This Source can only be configured if the Output Type is set to **Latched Logic or Inverse Latched Logic**. Is the state of the Unlatch Source normally closed, it turns the output state OFF in case the Output Type is set to **Latched Logic**. If the Unlatch Source state turns normally open afterwards, the output state stays OFF independent of the Output state before. The reverse behavior is valid for the **Inverse Latched Logic**.

The unlatch logic can be modified by **Unlatch Only by Unlatch Source**. If this parameter is set to True, the output state can only be unlatched by triggering the unlatch source. Otherwise, the outputs state stays ON whether the control source is triggered or not, in case Output Type Latched Logic is selected.

The parameter **Output Response upon Unlatch Removal** can be set to Latched and Immediate. By setting this parameter to Latched, the output state in Latched Logic will be normally open after the unlatch source got triggered and switched back to normally open. By setting this parameter to Immediate, however, the output state changes back to the state when the unlatch source was triggered after the unlatch source is normally open again. For instance, the output type is set to latched logic and the output state is normally closed. If the unlatch source is triggered, the output turns OFF. The output turns ON again after the unlatch source becomes normally open.

1.4.6. Digital Output Diagnostic Trouble Code Trigger

The principle of the digital output's diagnostic trouble code is the same as for the digital inputs. That is why this chapter refers to subchapter 1.3.4.

1.5. Diagnostics

1.5.1. General Diagnostics

The diagnostic messages of the DIO controller can be enabled or disabled by the Setpoint Name **Disable All Diagnostics Checking**. In case there is an empty DM1 message required, **Send empty DM1 message** can be enabled. Both Setpoints are Disabled by default.

1.5.2. Power Supply – Temperature – CAN - Diagnostics

By using the setpoint **Power Supply Diagnostics**, an undervoltage and/or overvoltage error of the DIO controller can be detected in case the setpoint **Fault Detection is Enabled** is set to true. The **Undervoltage Threshold** and the **Overvoltage Threshold** can be set in range of 8 to 36 Volts by the **Power Supply Diagnostics**. To clear these errors, the Setpoint **Hysteresis to Clear Voltage**

Fault can be configured. The undervoltage error clears, if the voltage reaches the defined clear voltage value plus the undervoltage threshold. This principle is also valid for the overvoltage. In this case, the clear voltage value will be subtracted of the overvoltage threshold. When the power supply reaches one of these values, the error will be cleared if **Event Cleared Only by DM11** is set to False.

An overheating can be detected with the **Temperature Diagnostics**. The settings can be enabled by the Setpoint **Fault Detection is Enabled**. If it's set to true, an error will be detected when the temperature reaches a value equal or higher than the configured **Over Temperature Threshold**. The detected error will be cleared if the temperature value is equal or smaller than the over temperature threshold subtracted by the **Hysteresis to Clear Temperature Fault**.

Both diagnostics, Power Supply and Temperature, have a parameter to disable all outputs. In case all outputs should be disabled when an overvoltage or undervoltage is measured, the parameter **Power Fault Disables Outputs** must be set to true. Whereas the parameter **Over Temperature Shutdown** disables the outputs when the unit is overheating.

In the **CAN Diagnostics**, an error will be detected when a CAN receive timeout appears. The error will be cleared if a new CAN receive message occurs.

By default, none of the Diagnostics sends a DTC on the network when one of the errors above is detected. If **Event Generates a DTC in DM1** is set to *TRUE*, the user has access to a full configuration of the DTC parameters. When **Event Cleared Only by DM11** parameter is set to *False*, the DTC is cleared when the controller no longer detects an error message at its respective diagnostic. However, when **Event Cleared Only by DM11** is *True*, the DTC will remain active after the controller no longer detects an error at its respective diagnostic until a DM11 message is sent to the controller. Upon reception of a DM11 message, if the controller is detecting an error at its respective diagnostic, the DTC **will not** be cleared. If, however, the controller no longer detects an error at its respective diagnostic upon reception of a DM11 message, the DTC will be cleared but the occurrence count **will** remain the same. If desired to clear the occurrence count, it is necessary for a DM3 message to be sent to the controller.

The setting for the for **Lamp Set by Event in DM1** and **Failure Mode Identifiers (FMI)** are the same as for the Digital Inputs and Outputs. Therefore Table 4: Lamp Set by Event in DM11 and Table 5: FMI for Event used in DTC are also valid for the discussed parameters in this subchapter.

1.5.3. Diagnostic Trouble Code (DTC) React

The DTC React function block will allow a received DTC sent from another ECU on a DM1 message to be used as an input source to control and/or enable/disable any output signal. Up to thirty (30) SPN/FMI combinations can be selected.

Should a DM1 message be received with the right **SPN/FMI to Trigger Reaction** combination, the corresponding DTC State will be set to ON. Once ON, if the same SPN/FMI combination has not been received again after 3 seconds, the DTC State will be reset to OFF.

By setting the parameter **Enable Specific Source Address** to true, a source address between 1 and 253 can be set with **Specific Source Address That Sends**.

1.6. LED Control

A bi-colour red and green LED lamp is mounted on the DIO front panel. It reflects internal states in five different stages, which can be set through the Axiomatic Electronic Assistant. Stage 1 has the highest priority while **Default** stage has the lowest. Table 11 shows the setting for stage 1 to 4 while the **Default** stage has no Control Source or Number because it is supposed to show the controller is On and without.

Table 11: LED Stages Settings

Stage Settings
Control Source
Output Type
Response Type
Blink Rate

1.6.1. LED Control Sources

The LED stages can be configured to be commanded by the LED control sources listed in Table 12. This table displays the control sources which can be selected.

Table 12: LED Control Sources

Value	Meaning
0	Control Source Not Used
1	Global Output Fault
2	Power Supply Fault
3	Processor Temperature Fault
4	CAN Receive Fault

Setting the stage to **Control Source Not Used** has no affect to the LED.

The **Global Output Fault** indicates a Power Supply Fault, Processor Temperature Fault, and CAN Receive Fault at one stage.

An overvoltage or undervoltage error can be shown with the source **Power Supply Fault**, while an overheating can be detected with the **Processor Temperature Fault**.

On condition the LED should report an CAN receive error, the source CAN Receive Fault is to choose.

The default configuration for each stage is deposited in section 3.2

1.6.2. LED Output/Response Type

The LED behavior can configure with different **Output Types**. Table 13 shows the different configuration possibilities.

Table 13: LED Output Types

Value	Output Type
0	LEDs Disabled
1	Green
2	Red
3	Toggle Green/Red

The LED is off in case the Output Type is set to **LEDs Disabled**. If the type is set to **Green**, the LED will shine only green for the selected stage. The same behavior is valid for the **Yellow** and the **Red** type. In case the **Toggle Green/Red** type is selected, the LED will blink in these colors when the Response Type is configured to **Blinking Logic**. The same is valid for **Toggle Yellow/Red**. Table 14 shows the possible response types for each stage and output type.

Table 14: LED Response Types

Value	Response Type
0	Normal OFF
1	Normal ON
2	Blinking Logic

How fast the toggle frequency is can be set by the **Blink Rate**, which is declared in milliseconds.

1.7. CAN Receive Function Block

The DIO controller supports up to 16 unique fully configurable CAN Receive Messages. The CAN Receive function block is designed to take any SPN from the J1939 network and use it as a **Control/Unlatch/Enable/Override Source** for any relay outputs or CAN transmits.

The **Receive Message Enabled** is the most important setpoint associated with this function block and it should be selected first. Changing it will result in other setpoints being enabled/disabled as appropriate. By default, all receive messages are disabled.

Once a message has been enabled, a Lost Communication fault will be flagged if that message is not received within the **Receive Message Timeout** period if this has been set to 10ms or higher. This will trigger a Lost Communication event and the output data of the CAN Receive message will be set to 0. To avoid timeouts (if set to 10ms or higher) on a heavily saturated network, it is recommended to set the period at least three times longer than the expected update rate. To disable the timeout feature, simply set this value to zero, in which case the received message will never timeout and will never trigger a Lost Communication event.

By default, all control messages are expected to be sent to the DIO controller on Proprietary B PGNs. However, should a PDU1 message be selected, the DIO controller can be configured to receive it from any ECU by setting the **Specific Address that sends the PGN** to the Global Address (0xFF). If a specific address is selected instead, then any other ECU data on the PGN will be ignored.

The **Receive Data Size**, **Receive Data Index in Array (LSB)**, **Receive Bit Index in Byte (LSB)**, **Receive Data Resolution** and **Receive Data Offset** can all be used to map any SPN supported by the J1939 standard to the output data of the Received function block.

The **Received Data Min** (Off Threshold) and **Received Data Max** (On Threshold) setpoints determine the minimum and maximum values of the control signal. As the names imply, they are also used as the ON/OFF thresholds for digital level types. These values are in whatever units the incoming data is after the resolution and offset are applied to the CAN Receive signal.

To have a CAN Receive message trigger, a relay output ON or OFF is to make sure the **Receive Data Min (OFF Threshold)** and **Receive Data Max (ON Threshold)** parameters are adjusted to the user's application. When the CAN Receive message (after having the resolution and offset applied to it), anything at **Receive Data Max (ON Threshold)** parameter or higher, will trigger an ON command. Similarly, anything at **Receive Data Min (OFF Threshold)** parameter or lower will trigger an OFF command. Any data in between will not change the state, thus providing a hysteresis. Figure 2 illustrates this behaviour.

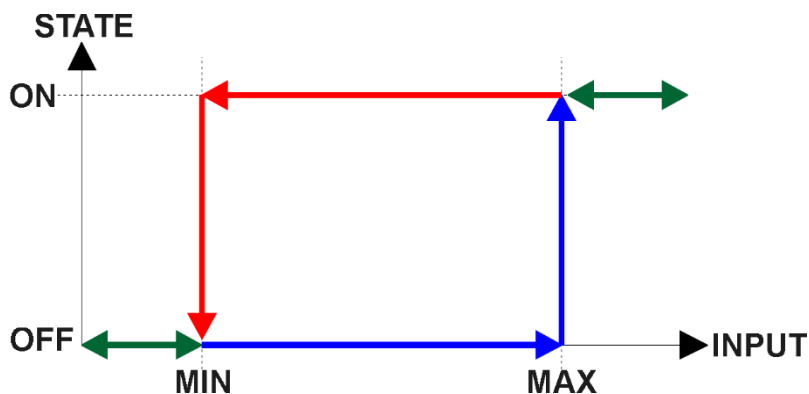

Figure 2: CAN Receive Message to Digital Output State

1.8. CAN Transmit Function Block

The DIO-Controller provides up to 12 fully configurable CAN Transmit messages. Each block has an own **Transmit PGN** while the first three CAN Transmit messages have by default a **PGN** of 0xFF00. The Forth down to the 12th CAN Transmit Block have different PGNs by default. Thereby, the forth starts with a PGN of 0xFF01 counting down to the 12th CAN Transmit Block, which has a PGN of 0xFF09.

A pre-defined CAN Transmit message is used to transmit the Digital Input and Digital Output states of the DIO controller to the J1939 network. The Digital Input and output states are 1-bit size long occupying the first 3 bytes of the CAN Transmit message. Paragraph 2.3 shows the default values of this message.

The CAN transmit message is always enabled and the **Transmit Repetition Rate** defines to which time in milliseconds the CAN transmit message is repeated. The CAN message will not transmit on

the J1939 network in case all CAN transmits have the same PGN and the **Transmit Repetition Rate** of the first CAN transmit is set to zero.

The CAN Transmit messages can be sent on any Proprietary A or B PGN as broadcast messages. By default, the **Transmit Message Priority** is set to 6 (low priority).

Enabling the **Override Source Address**, the **Source Address** of the J1939 Identifier can be changed to any value between 0...255.

The **Transmit Data Size**, **Transmit Data Index in Array (LSB)**, **Transmit Bit Index in Byte (LSB)**, **Transmit Data Resolution**, and **Transmit Data Offset** can all be used to map any SPN supported message by the J1939 standard from any **Data Source/Number** of the Transmit Function Block. Table 15 exhibits the possible Sources for the CAN Transmits.

Table 15: CAN Transmit Control Sources

Value	Meaning	Source Range
0	<i>Source Not Used</i>	[0]
1	<i>Digital Input</i>	[1...12]
2	<i>Digital Relay Output</i>	[1...8]
3	<i>Power Supply Voltage Fault State</i>	[0]
4	<i>Temperature Fault State</i>	[0]
5	<i>Diagnostic Trouble Code</i>	[1...30]
6	<i>CAN Receive</i>	[1...10]
7	<i>Conditional Block</i>	[1...10]
8	<i>CAN Status Reports</i>	[1...3]
9	<i>Global Power Supply Voltage</i>	[0]
10	<i>Global Temperature</i>	[0]

In case the source **CAN Status Reports** is selected, the minimum **Transmit Data Size** must be one Byte. Otherwise, data loss cannot be excluded. The same is valid for the sources **Global VPS** and **Global Temperature**.

1.9. CAN Status Reports

The DIO controller provides CAN Status Report messages to merge more than one state in a CAN Transmit message. Each CAN Status Report provides eight Control Sources, Control Numbers, and Bit Locations. This way, it is possible to create a one-byte message with up to 8 status bits. The Bit Location of each status bit is configurable between Bit Location 1 and Bit Location 8. Any Bit Location which is not set to a Source will be set to zero. Table 16 shows the Control Sources of the CAN Status Reports with their Control Number ranges.

Table 16: CAN Status Report Control Sources

Value	Meaning	Source Range
0	No Source	[0]
1	<i>Digital Input</i>	[1...12]

2	Relay Output	[1...8]
3	<i>CAN Receive Message</i>	<i>[1...10]</i>
4	<i>CAN Transmit Message</i>	<i>[1...12]</i>
5	<i>Diagnostic Trouble Code</i>	<i>[1...30]</i>
6	<i>CAN Receive</i>	<i>[1...10]</i>
7	<i>Conditional Block</i>	<i>[1...10]</i>

The Sources Digital Input and Digital Output are set as default for the three CAN Status Reports. Thereby, the first CAN Status Report has the first 8 Digital Input States, while the second one has the last four Inputs states and the first four Output states. The third CAN Status Report message merges the last four states of the Digital Outputs while Bit Location 5 to 8 are empty.

1.10. Conditional Block

The Conditional Block compares up to four different input sources with different logical or relational operators. The result of each block can therefore only be true (1) or false (0). Figure 3 demonstrates the connections between all parameters.

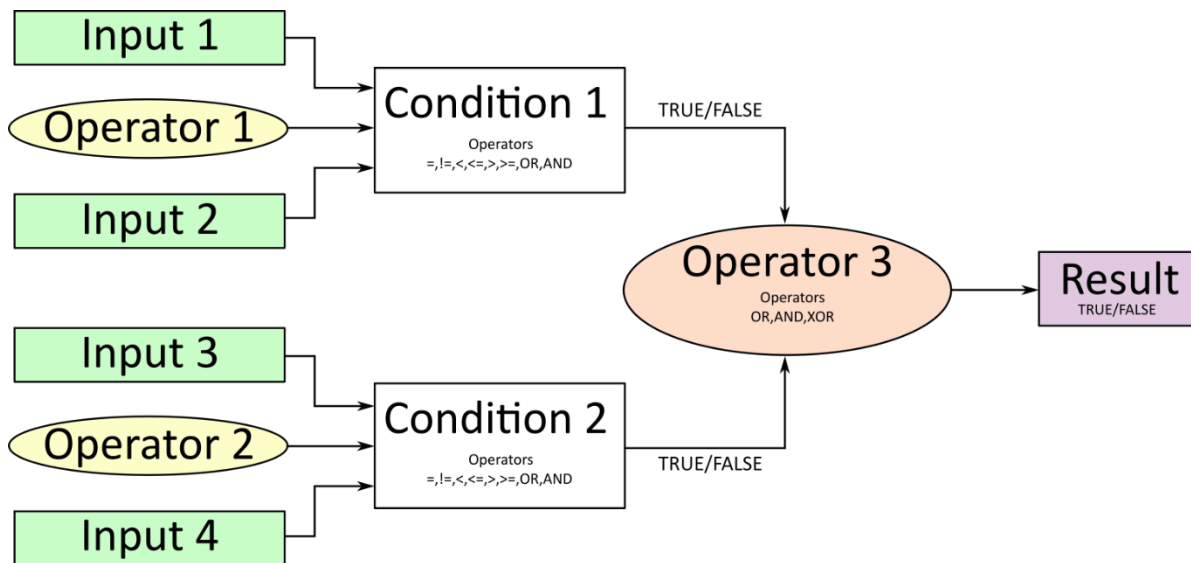

Figure 3: Conditional Block Diagram

Each Conditional Block offers two conditions. Both compare two inputs, which can hold a logical value or an integer value. The output of the conditions can only be true or false and will be compared by Operator 3 with a logical operator. This comparison is the result of the Conditional Block and can control any output source.

The value of Input 1 to Input 4 depends on the configured control source and control number. Table 17 shows the available sources for each Argument.

Table 17: Conditional Block Input Sources

Value	Meaning	Source Range
0	No Source	[0]

1	Digital Input	[1...12]
2	<i>Relay Output</i>	<i>[1...8]</i>
3	<i>CAN Receive Message</i>	<i>[1...10]</i>
4	<i>CAN Transmit Message</i>	<i>[1...12]</i>
5	<i>Diagnostic Trouble Code</i>	<i>[1...30]</i>
6	<i>CAN Receive</i>	<i>[1...10]</i>
7	<i>Conditional Block</i>	<i>[1...10]</i>

All Inputs are set to Digital Input one to four as an input source by default. The value of each source will then be compared to each other with an operator of Table 18. If no source is selected, the output value of an Input will be zero.

Table 18: Input Operator Options

Value	Meaning
0	==, True when Argument 1 is equal to Argument 2
1	!=, True when Argument 1 is not equal to Argument 2
2	>, True when Argument 1 is greater than Argument 2
3	>=, True when Argument 1 is greater than Argument 2
4	<, True when Argument 1 is less than Argument 2
5	<=, True when Argument 1 is less than or equal Argument 2
6	OR, True when Argument 1 or Argument 2 is True
7	AND, True when Argument 1 and Argument 2 are True

Operator 1 and Operator 2 are configured to AND by default. The table above cannot be used for comparing the conditions because they can only be compared with logical operators, which are listed in Table 19.

Table 19: Condition Operator Options

Value	Meaning
0	OR, True when Argument 1 or Argument 2 is True
1	AND, True when Argument 1 and Argument 2 are True
2	XOR, True when Argument 1 is not equal to Argument 2

If only one condition is used, it is to make sure that Operator 3 is set to **OR** so that the result is based solely on the condition which has been chosen.

2. OVERVIEW OF J1939 FEATURES

The software was designed to provide flexibility to the user with respect to messages sent to and from the ECU by providing:

- Configurable ECU Instance in the NAME (to allow multiple ECUs on the same network)
- Configurable Transmit PGN and SPN Parameters
- Configurable Receive PGN and SPN Parameters
- Sending DM1 Diagnostic Message Parameters

- Reading and reacting to DM1 messages sent by other ECUs
- Diagnostic Log, maintained in non-volatile memory, for sending DM2 messages

2.1. Introduction To Supported Messages

The ECU is compliant with the standard SAE J1939, and supports the following PGNs

From J1939-21 - Data Link Layer

- | | |
|--|------------------|
| • Request | 59904 (\$00EA00) |
| • Acknowledgment | 59392 (\$00E800) |
| • Transport Protocol – Connection Management | 60416 (\$00EC00) |
| • Transport Protocol – Data Transfer Message | 60160 (\$00EB00) |
| • PropB Transmit, Default Digital I/O State Feedback | 65280 (\$00FF00) |
| • PropB Receive, Default Control Source Data Message | 65408 (\$00FF80) |
| • PropB Receive, Default Control Source Data Message | 65409 (\$00FF81) |
| • PropB Receive, Default Control Source Data Message | 65410 (\$00FF82) |
| • PropB Receive, Default Control Source Data Message | 65411 (\$00FF83) |
| • PropB Receive, Default Control Source Data Message | 65412 (\$00FF84) |
| • PropB Receive, Default Control Source Data Message | 65413 (\$00FF85) |
| • PropB Receive, Default Control Source Data Message | 65414 (\$00FF86) |
| • PropB Receive, Default Control Source Data Message | 65415 (\$00FF87) |

Note: Any Proprietary B PGN in the range 65280 to 65535 (\$00FF00 to \$00FFFF) can be selected
 Note: The Proprietary A PGN 61184 (\$00EF00) can also be selected for any CAN Receive or CAN Transmit messages.

From J1939-73 - Diagnostics

- | | |
|--|------------------|
| • DM1 – Active Diagnostic Trouble Codes | 65226 (\$00FECA) |
| • DM2 – Previously Active Diagnostic Trouble Codes | 65227 (\$00FECB) |
| • DM3 – Diagnostic Data Clear/Reset for Previously Active DTCs | 65228 (\$00FECC) |
| • DM11 - Diagnostic Data Clear/Reset for Active DTCs | 65235 (\$00FED3) |
| • DM14 – Memory Access Request | 55552 (\$00D900) |
| • DM15 – Memory Access Response | 55296 (\$00D800) |
| • DM16 – Binary Data Transfer | 55040 (\$00D700) |

From J1939-81 - Network Management

- | | |
|--------------------------------|------------------|
| • Address Claimed/Cannot Claim | 60928 (\$00EE00) |
| Commanded Address | 65240 (\$00FED8) |

From J1939-71 – Vehicle Application Layer

- | | |
|---------------------------|------------------|
| • Software Identification | 65242 (\$00FEDA) |
|---------------------------|------------------|

None of the application layer PGNs are supported as part of the default configurations, but they can be selected as desired for either transmit or received function blocks.

Setpoints are accessed using standard Memory Access Protocol (MAP) with proprietary addresses. The Axiomatic Electronic Assistant (EA) allows for quick and easy configuration of the unit over the CAN network.

2.2. J1939 Name, Address and Software ID

The DIO controller has a J1939 name which is broadcasted at power up and/or when its ECU Address has been changed. The Software ID PGN gives useful information regarding the DIO controller.

2.2.1. J1939 Name

The DIO ECU has the following defaults for the J1939 Name. The user should refer to the SAE J1939/81 standard for more information on these parameters and their ranges.

Arbitrary Address Capable	Yes
Industry Group	0, Global
Vehicle System Instance	0
Vehicle System	0, Non-specific system
Function	126, Axiomatic I/O Controller
Function Instance	3, Axiomatic AXDIO128, 12 Digital Input, 8 Relay Output Controller
ECU Instance	0, First Instance
Manufacture Code	162, Axiomatic Technologies Corporation
Identity Number	Variable, uniquely assigned during factory programming for each ECU

The ECU Instance is a configurable setpoint associated with the NAME. Changing this value will allow multiple ECUs of this type to be distinguishable by other ECUs (including the Axiomatic Electronic Assistant) when they are all connected on the same network.

2.2.2. ECU Address

The default value of this setpoint is 128 (0x80), which is the preferred starting address for self-configurable ECUs as set by the SAE in J1939 tables B3 to B7. The Axiomatic EA will allow the selection of any address between 0 to 253, and ***it is the user's responsibility to select an address that complies with the standard.*** The user must also be aware that since the unit is arbitrary address capable, if another ECU with a higher priority NAME contends for the selected address, the DIO will continue select the next highest address until it finds one that it can claim. See J1939/81 for more details about address claiming.

2.2.3. Software Identifier

PGN 65242	Software Identification	- SOFT
Transmission Repetition Rate:	On request	
Data Length:	Variable	
Extended Data Page:	0	
Data Page:	0	
PDU Format:	254	
PDU Specific:	218 PGN Supporting Information:	
Default Priority:	6	
Parameter Group Number:	65242 (0xFEDA)	
Start Position	Length	Parameter Name
1	1 Byte	Number of software identification fields
2-n	Variable	Software identification(s), Delimiter (ASCII “**”) 234

For the DIO ECU, Byte 1 is set to 1, and the identification fields are as follows

(Version)*

The Axiomatic EA shows all this information in “General ECU Information”, as shown below:

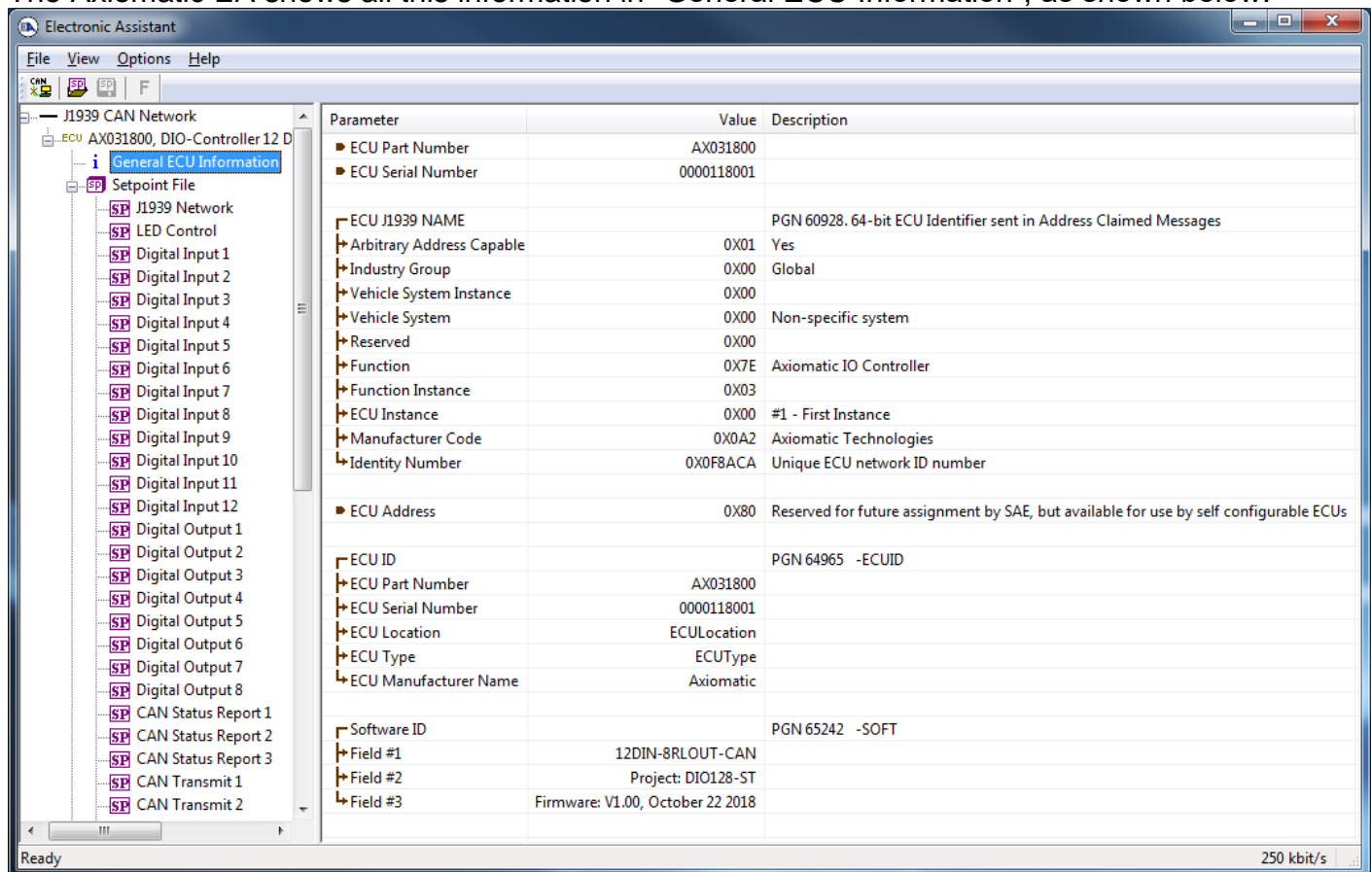

Note: The information provided in the Software ID is available for any J1939 service tool which supports the PGN -SOFT.

2.3. CAN Transmit Message Default

This section outlines the **default** settings of the DIO CAN transmission. Recall, however, that this is a programmable function block, such that all these SPNs can be sent on different PGNs if so desired.

In all the messages shown below, not all the transmitted values have an SPN assigned to them, as this ECU only uses the SPNs for diagnostic trouble codes.

The “Digital Input and Relay Output State Feedback” has the following default configuration.

PGN 65280 Digital Input and Relay Output State Feedback

Transmission Repetition: 1000ms (1 second transmit rate)

Data Length: 8

Data Page: 0

PDU Format: 254

PDU Specific: GE PGN Supporting Information:

Default Priority: 6

Parameter Group Number: 65280(0xFF00)

Start Position	Length	Parameter Name
1.1	1 bit	Digital Input 1 State
1.2	1 bit	Digital Input 2 State
1.3	1 bit	Digital Input 3 State
1.4	1 bit	Digital Input 4 State
1.5	1 bit	Digital Input 5 State
1.6	1 bit	Digital Input 6 State
1.7	1 bit	Digital Input 7 State
1.8	1 bit	Digital Input 8 State
2.1	1 bit	Digital Input 9 State
2.2	1 bit	Digital Input 10 State
2.3	1 bit	Digital Input 11 State
2.4	1 bit	Digital Input 12 State
2.5	1 bit	Relay Output 1 State
2.6	1 bit	Relay Output 2 State
2.7	1 bit	Relay Output 3 State
2.8	1 bit	Relay Output 4 State
3.1	1 bit	Relay Output 5 State
3.2	1 bit	Relay Output 6 State
3.3	1 bit	Relay Output 7 State
3.4	1 bit	Relay Output 8 State
3.5	1 bit	Empty
3.6	1 bit	Empty
3.7	1 bit	Empty
3.8	1 bit	Empty

3. ECU SETPOINTS ACCESSED WITH THE AXIOMATIC ELECTRONIC ASSISTANT

Many setpoints have been reference throughout this manual. This section describes in detail each setpoint, their defaults and ranges. For more information on how each setpoint is used by the DIO controller, refer to the relevant section of the User Manual.

3.1. J1939 Network Setpoints

The J1939 Network setpoints deal with the setpoints such as *ECU Instance Number* and *ECU Address*. Figure 4 and Table 20 below will explain these setpoints and their ranges.

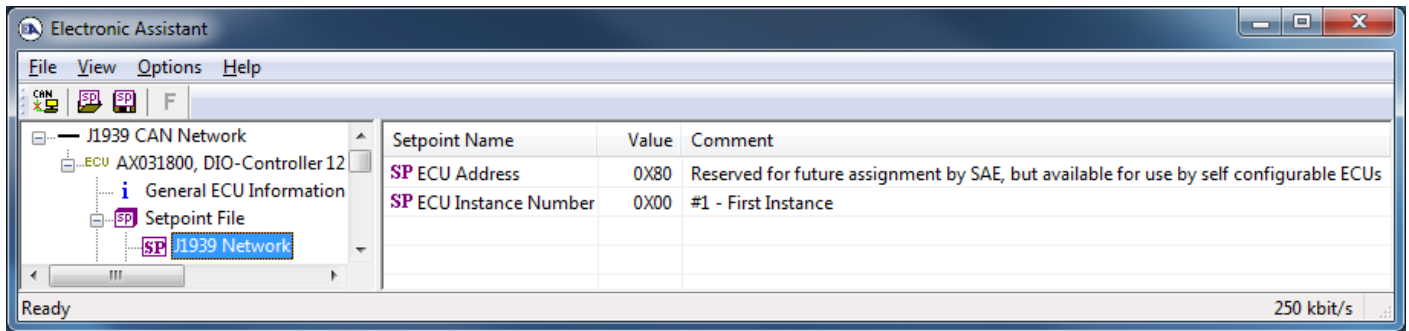

Figure 4: Screen Capture of Default J1939 Network Setpoints

Table 20: Default J1939 Network Setpoints

Name	Range	Default	Notes
ECU Address	0 to 253	128 (0x80)	Preferred address for a self-configurable ECU
ECU Instance Number	Drop List	0, #1 – First Instance	Per J1939-81

3.2. LED Control Setpoints

The LED Control setpoints are defined in section 1.6. Refer to that section for detailed information on how these setpoints are used. The screen capture below in Figure 5 displays the available setpoints for each of the LED Control stages. Table 21 below highlights the allowable ranges for each setpoint.

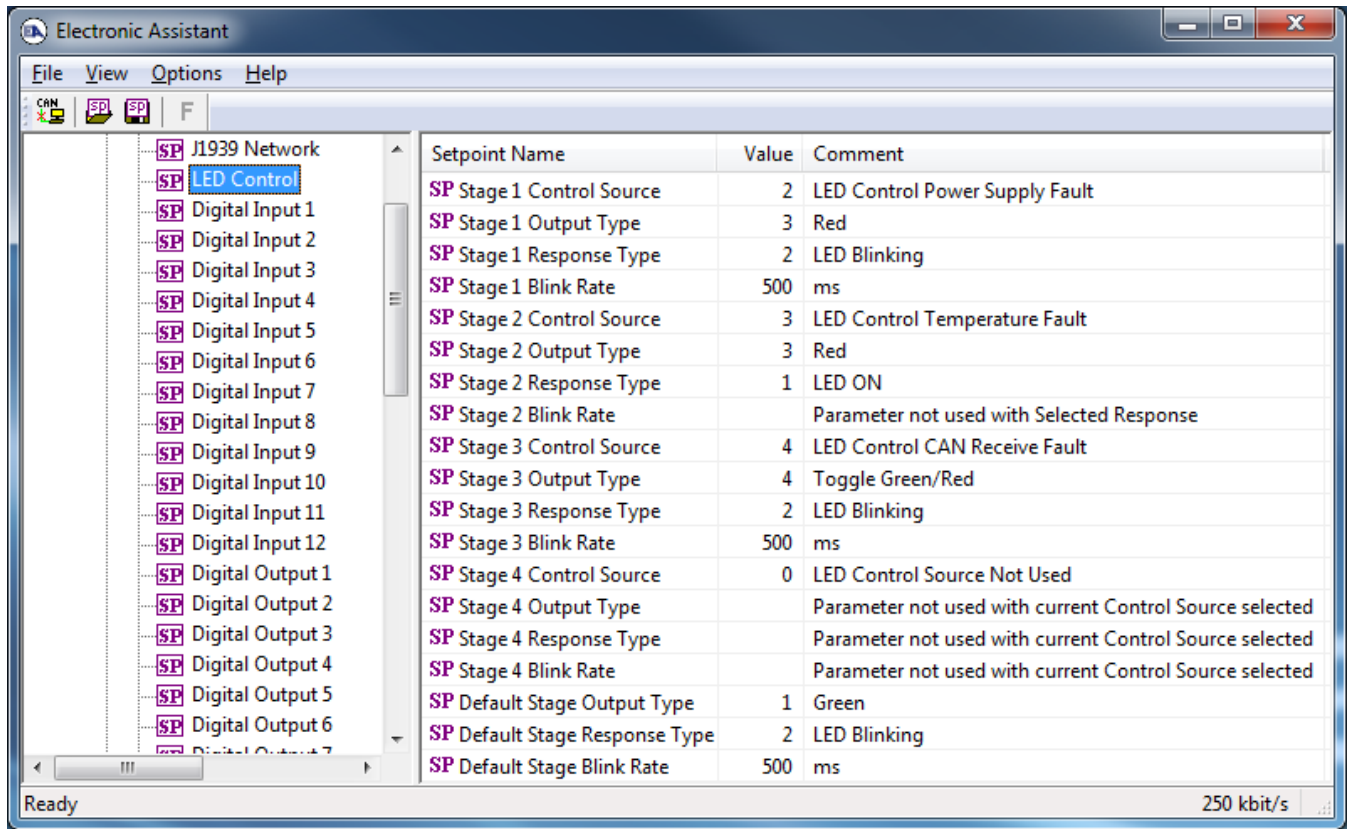

Figure 5: Screen Capture of Default LED Control Setpoints

Table 21: Default LED Control Setpoints

Name	Range	Default	Notes
Stage 1 Control Source	Drop List	LED Control Power Supply Fault	Refer to Section 1.6.1
Stage 1 Output Type	Drop List	Red	Refer to Section 1.6.2
Stage 1 Response Type	Drop List	LED Blinking	Refer to Section 1.6.2
Stage 1 Blink Rate	0...60,000	500	Units in [milliseconds]
Stage 2 Control Source	Drop List	LED Control Temperature Fault	Refer to Section 1.6.1
Stage 2 Output Type	Drop List	Red	Refer to Section 1.6.2
Stage 2 Response Type	Drop List	LED ON	Refer to Section 1.6.2
Stage 2 Blink Rate	0...60,000	-	
Stage 3 Control Source	Drop List	LED Control CAN Receive Fault	Refer to Section 1.6.1
Stage 3 Output Type	Drop List	Toggle Green/Red	Refer to Section 1.6.2
Stage 3 Response Type	Drop List	LED Blinking	Refer to Section 1.6.2
Stage 3 Blink Rate	0...60,000	500	Units in [milliseconds]
Stage 4 Control Source	Drop List	LED Control Source Not Used	Refer to Section 1.6.1
Stage 4 Output Type	Drop List	-	Refer to Section 1.6.2
Stage 4 Response Type	Drop List	-	Refer to Section 1.6.2
Stage 4 Blink Rate	0...60,000	-	Refer to Section 1.6.2
Default Stage Output Type	Drop List	Green	Refer to Section 1.6.2
Default Stage Response Type	Drop List	LED Blinking	Refer to Section 1.6.2
Default Stage Blink Rate	0...60,000	500	Refer to Section 1.6.2

3.3. Digital Input Setpoints

The Digital Input setpoints are defined in Section 1.3. Refer to that section for detailed information on how these setpoints are used. The screen capture below in Figure 6 displays the available setpoints for each of the Digital Inputs. Table 22 below highlights the allowable ranges for each setpoint.

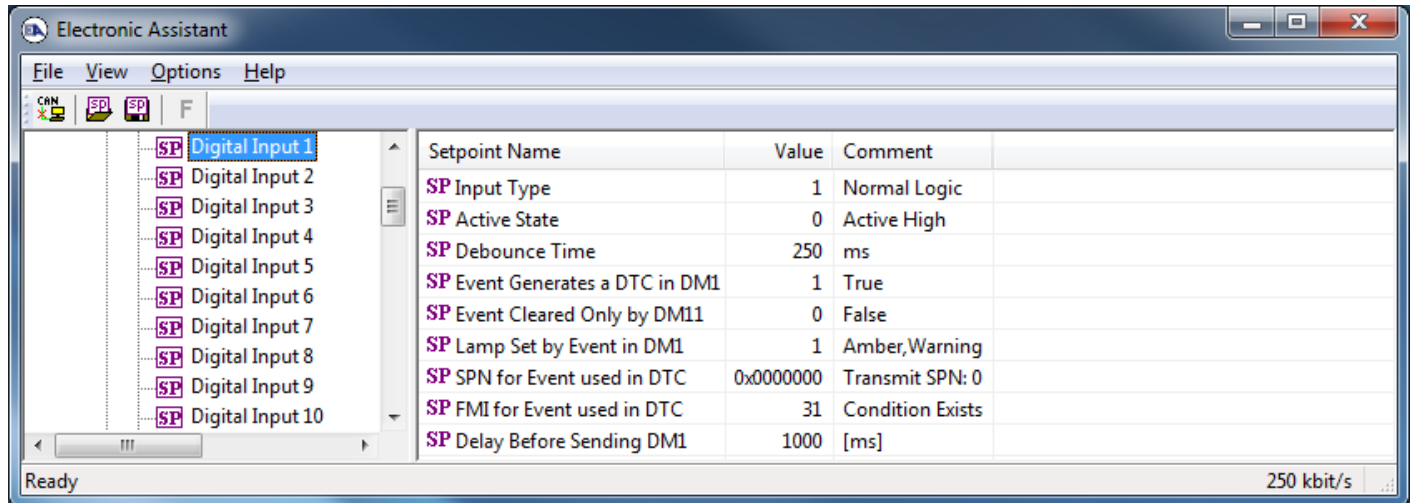

Figure 6: Screen Capture of Default Digital Input Setpoints

Table 22: Default Digital Input Setpoints

Name	Range	Default	Notes
Input Type	Drop List	Normal Logic	Refer to Section
Active High/Active Low	Drop List	Active High	
Digital Input Debounce Time	0...5,000	250	Units in [milliseconds]
Event Generates a DTC in DM1	Drop List	False	Default changed to <i>True</i> for illustration purposes. When <i>False</i> , the Digital Input will not trigger a fault on a DM1
Event Cleared Only by DM11	Drop List	False	When set to <i>True</i> , only DM11 messages will clear the fault if the input is no longer active. Refer to subsection 1.3.4
Lamp Set by Event in DM1	Drop List	Protect	Refer to Table 4
SPN for Event used in DTC	0...524,287	0	
FMI for Event used in DTC	Drop List	Condition Exists	Refer to Table 5
Delay Before Sending DM1	0...84,600,000	1000	If digital input remains ON after this time, a DTC will be sent on a DM1
Delay Before Clearing DM1	0...84,600,000	0	If digital output OFF after this time, a DTC will not be sent on a DM1 message anymore.

3.4. Relay Output Setpoints

The Relay Output setpoints are defined in Section 1.4. Refer to that section for detailed information on how these setpoints are used. The screen capture below in Figure 7 displays the available setpoints for each of the Digital Outputs. The table below highlights the allowable ranges for each setpoint.

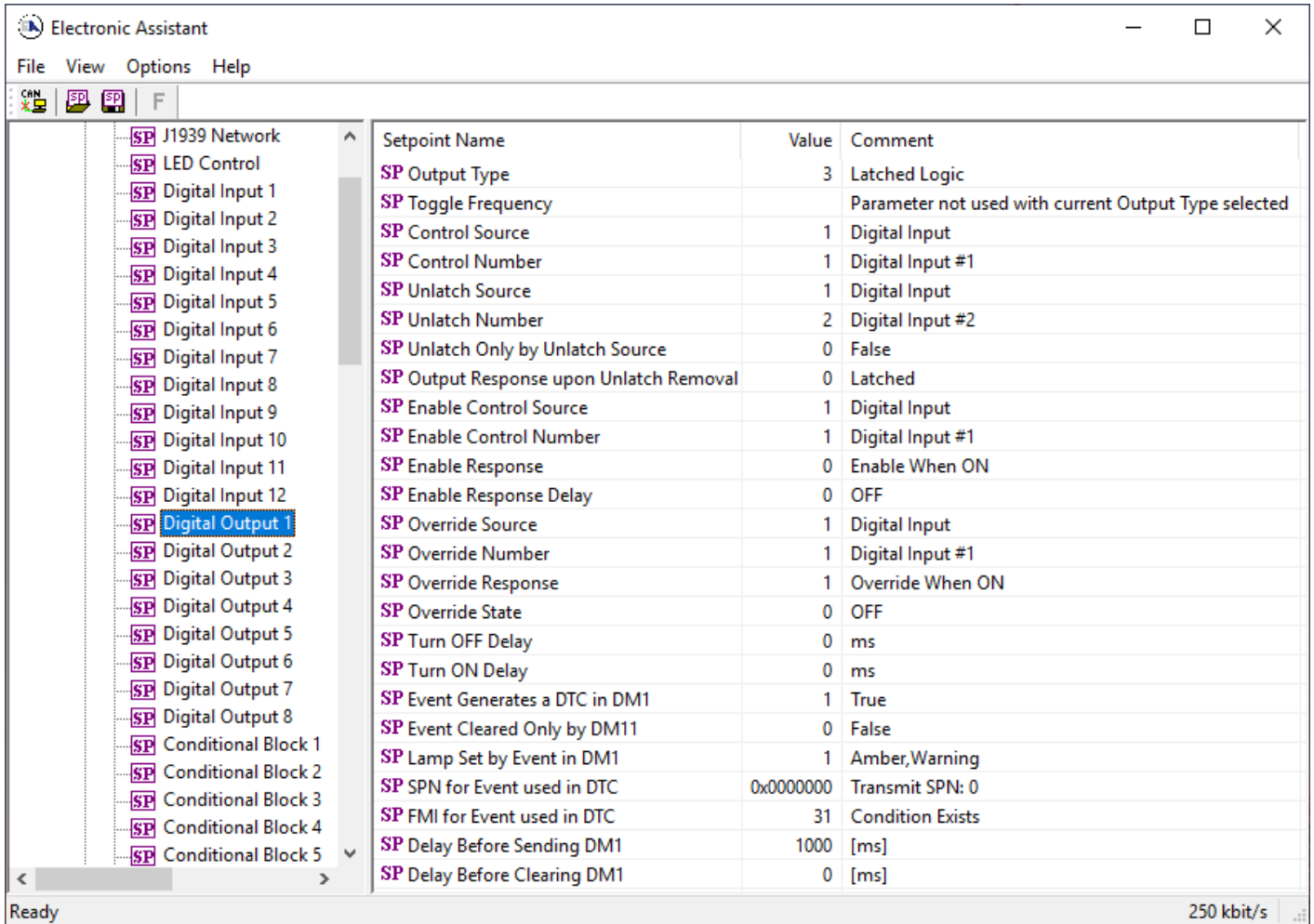

Figure 7: Screen Capture of Default Relay Output Setpoints

Table 23: Default Output Relay Setpoints

Name	Range	Default	Notes
Output Type	Drop List	Normal Logic	Default changed to <i>Latched Logic</i> for illustration purposes. Refer to Table 6
Toggle Frequency	0...60,000	500	Units in [milliseconds]
Control Source	Drop List	Digital Input	Refer to Table 7
Control Number	Depends on Source Selected	1...12	Refer to Table 7
Unlatch Source	Drop List	Source Not Used	Default changed to <i>Digital Input</i> for illustration purposes. Refer to Table 7
Unlatch Number	Depends on Source Selected	-	Refer to Table 7
Unlatch Only by Unlatch Source	Drop List	False	
Output Response upon Unlatch Removal	Drop List	Latched	
Enable Source	Drop List	Source not Used	Default changed to <i>Digital Input 2</i> for illustration purposes. Refer to Table 7

Enable Number	Depends on Source Selected	-	Refer to Table 7
Enable Response	Drop List	Enable When ON	Refer to Table 8
Enable Response Delay	Drop List	False	Refer to subchapter
Override Source	Drop List	Source not Used	Default changed to <i>Digital Input 3</i> for illustration purposes. Refer to Table 7
Override Number	Depends on Source Selected	-	Refer to Table 7
Override Response	Drop List	Enable When ON	Refer to Table 9
Override State	Drop List	False	Refer to Table 10
Turn OFF Delay	0...84,600,000	0	
Turn ON Delay	0...84,600,000	0	
Event Generates a DTC in DM1	Drop List	False	Default changed to <i>True</i> for illustration purposes. When <i>False</i> , the Digital Output will not trigger a fault on a DM1
Event Cleared Only by DM11	Drop List	False	When set to <i>True</i> , only DM11 messages will clear the fault if the output is no longer active. Refer to subsection 1.3.4
Lamp Set by Event in DM1	Drop List	Protect	Refer to Table 4
SPN for Event used in DTC	0...524,287	0	
FMI for Event used in DTC	Drop List	Condition Exists	Refer to Table 5
Delay Before Sending DM1	0...84,600,000	1,000	If digital output remains ON after this time, a DTC will be sent on a DM1.
Delay Before Clearing DM1	0...84,600,000	0	If digital output OFF after this time, a DTC will not be sent on a DM1 message anymore.

3.5. Conditional Block

The Conditional Block setpoints are defined in Section 1.10. Refer to that section for detailed information on how these setpoints are used. The screen capture in Figure 8 displays the available setpoints for each of the Conditional Blocks. The table below the screen capture highlights the allowable ranges for each setpoint.

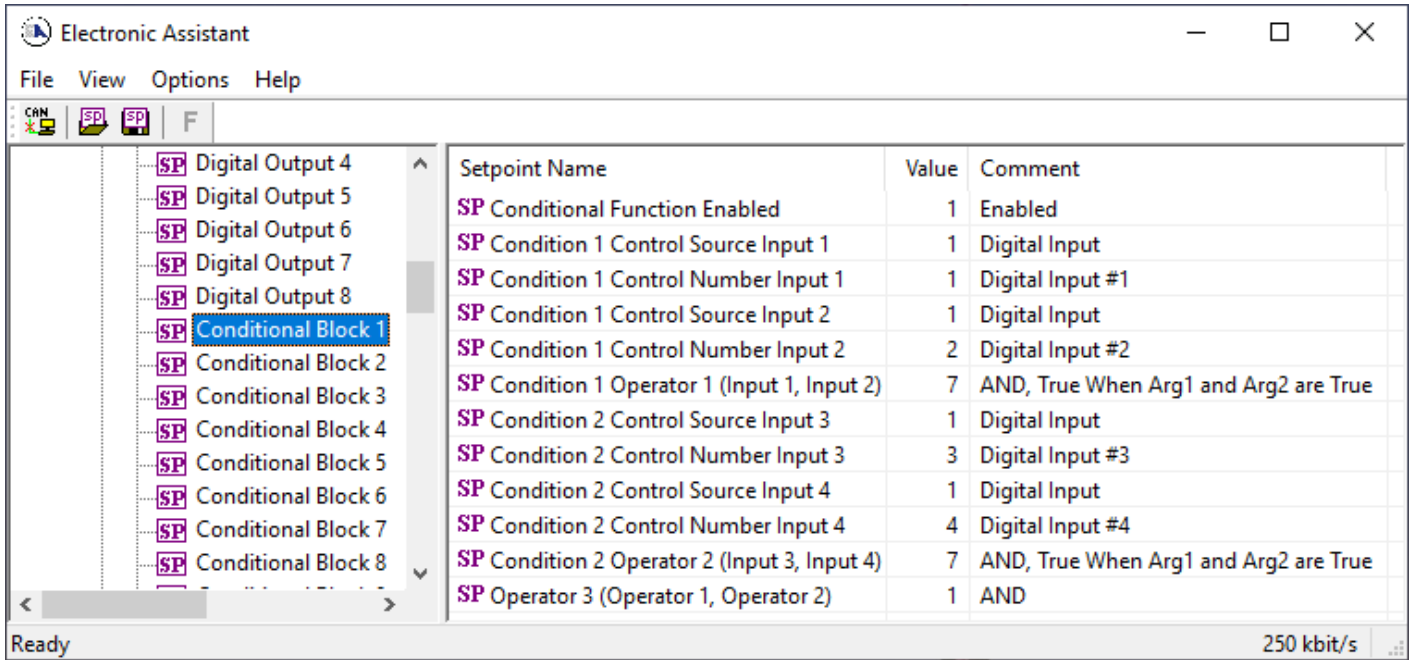

Figure 8: Screen Capture of Conditional Block Setpoints

Table 24: Default Conditional Block Setpoints

Name	Range	Default	Notes
Conditional Function Enabled	Drop List	Disabled	Default changed to <i>Enabled</i> for illustration purposes.
Condition 1 Control Source Input 1	Drop List	Digital Input	Refer to Table 17
Condition 1 Control Number Input 1	Depends on Source Selected	1	
Condition 1 Control Source Input 2	Drop List	Digital Input	Refer to Table 17
Condition 1 Control Number Input 2	Depends on Source Selected	1	
Condition 1 Operator 1(Input 1, Input 2)	0...7	7	Refer to Table 18
Condition 2 Control Source Input 3	Drop List	Digital Input	Refer to Table 17
Condition 2 Control Number Input 3	Depends on Source Selected	1	
Condition 2 Control Source Input 4	Drop List	Digital Input	Refer to Table 17
Condition 2 Control Number Input 4	Depends on Source Selected	1	
Condition 2 Operator 2(Input 3, Input 4)	0...7	7	Refer to Table 18
Operator 3 (Condition 1, Condition 2)	0...2	1	Refer to Table 19

3.6. Constant Data List Setpoints

The Constant Data List function block is provided to allow the user to select values as desired for various logic block functions.

The first two constants are fixed values of 0 (False) and 1 (True) for use in binary logic. The remaining 8 constants are fully user configurable to any value between +/- 1,000,000. The default values are displayed in the screen capture below.

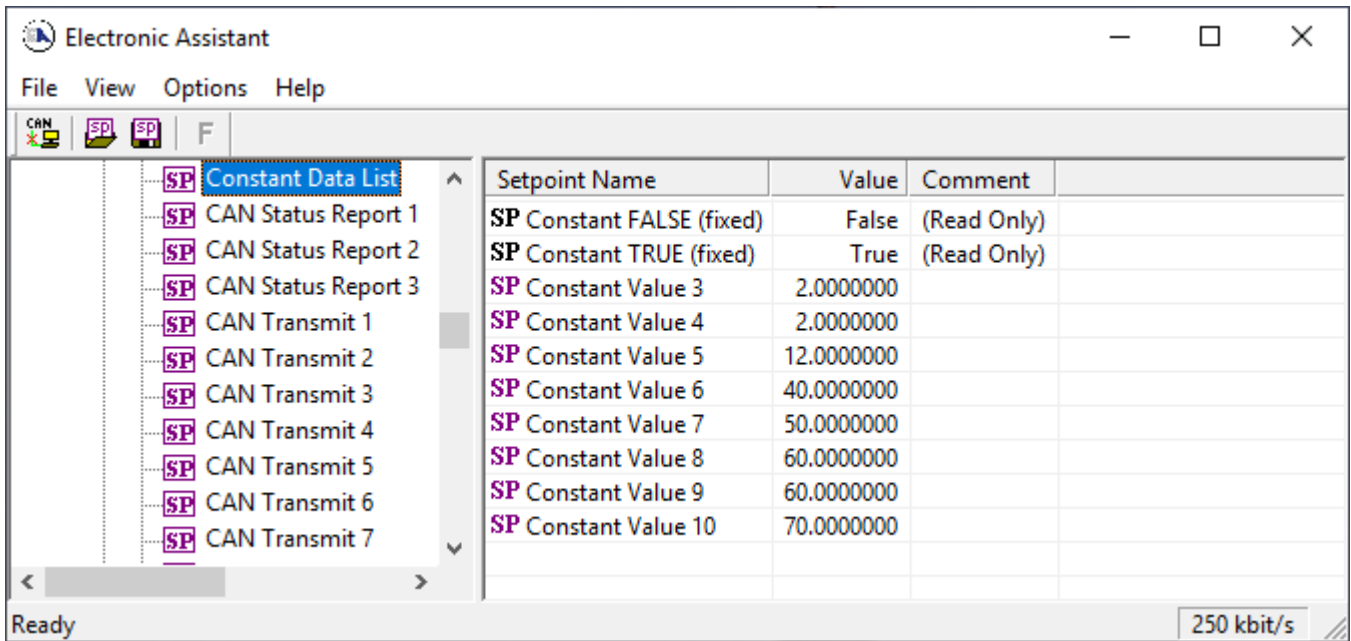

Figure 9: Screen Capture of Constant Data Setpoints

3.7. CAN Status Report Setpoints

The Relay Output setpoints are defined in Section 1.4. Refer to that section for detailed information on how these setpoints are used. The screen capture in Figure 10 displays the available setpoints for each of the CAN Status Reports (CSR). Table 25 below highlights the allowable ranges for each setpoint.

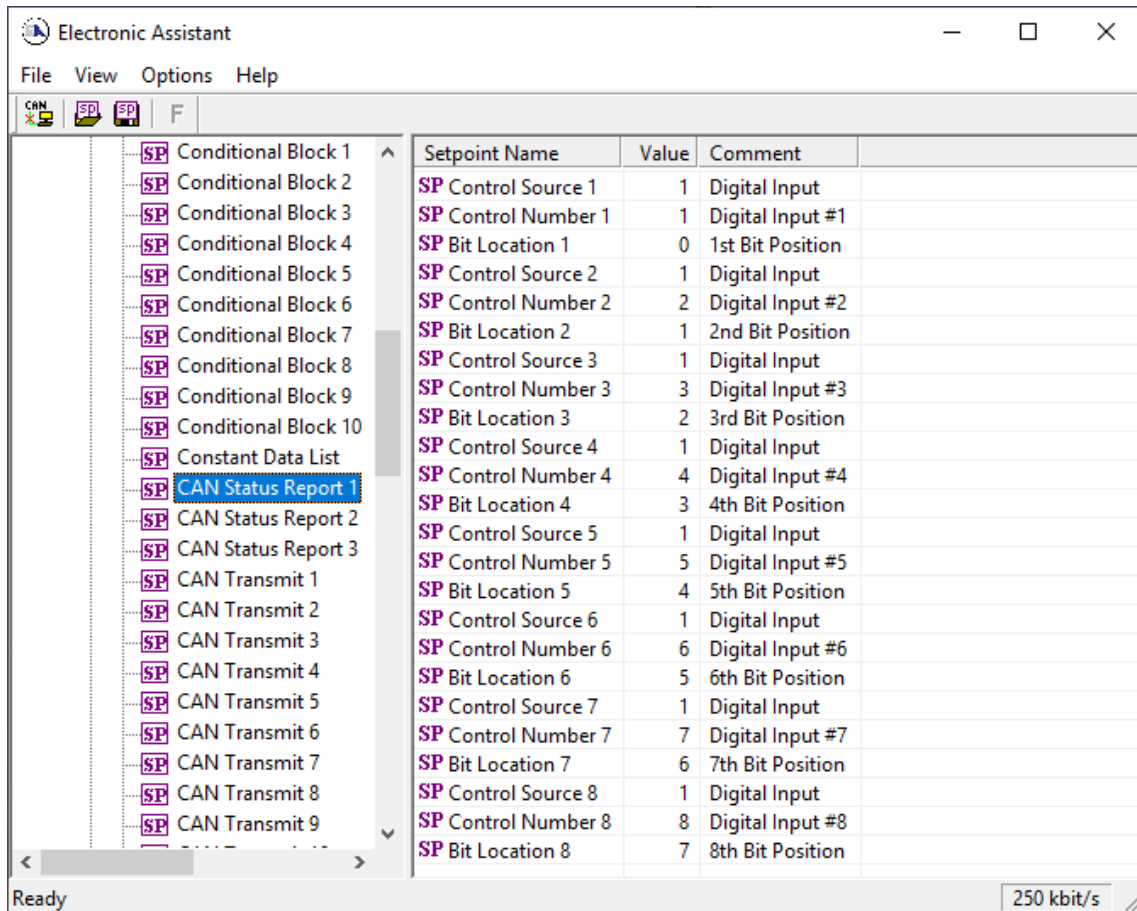

Figure 10: Screen Capture of Default CAN Status Reports

Table 25: Default CAN Status Report (CSR) Setpoints

Name	Range	Default CSR 1	Default CSR 2	Default CSR 3	Notes
Control Source 1	Drop List	Digital Input	Digital Input	Digital Output	Refer to Table 16
Control Number 1	Depends on Source Selected	1	9	5	Refer to Table 16
Bit Location 1	[1...8]	0	0	0	
Control Source 2	Drop List	Digital Input	Digital Input	Digital Output	Refer to Table 16
Control Number 2	Depends on Source Selected	2	10	6	Refer to Table 16
Bit Location 2	[1...8]	1	1	1	
Control Source 3	Drop List	Digital Input	Digital Input	Digital Output	Refer to Table 16
Control Number 3	Depends on Source Selected	3	11	7	Refer to Table 16
Bit Location 3	[1...8]	2	2	2	
Control Source 4	Drop List	Digital Input	Digital Input	Digital Output	Refer to Table 16
Control Number 4	Depends on Source Selected	4	12	8	Refer to Table 16
Bit Location 4	[1...8]	3	3	3	
Control Source 5	Drop List	Digital Input	Digital Output	No Source	Refer to Table 16
Control Number 5	Depends on Source Selected	5	1	-	Refer to Table 16
Bit Location 5	[1...8]	4	4	-	
Control Source 6	Drop List	Digital Input	Digital Output	No Source	Refer to Table 16

Control Number 6	Depends on Source Selected	6	2	-	Refer to Table 16
Bit Location 6	[1...8]	5	5	-	
Control Source 7	Drop List	Digital Input	Digital Output	No Source	Refer to Table 16
Control Number 7	Depends on Source Selected	7	3	-	Refer to Table 16
Bit Location 7	[1...8]	6	6	-	
Control Source 8	Drop List	Digital Input	Digital Output	No Source	Refer to Table 16
Control Number 8	Depends on Source Selected	8	4	-	Refer to Table 16
Bit Location 8	[1...8]	7	7	-	

3.8. CAN Transmit Setpoints

The CAN Transmit setpoints are defined in Section 1.8. Refer to that section for detailed information on how these setpoints are used. The screen capture below in Figure 11 displays the available setpoints for the CAN Transmit setpoints. Table 26 below highlights the allowable ranges for the first CAN Transmit setpoint.

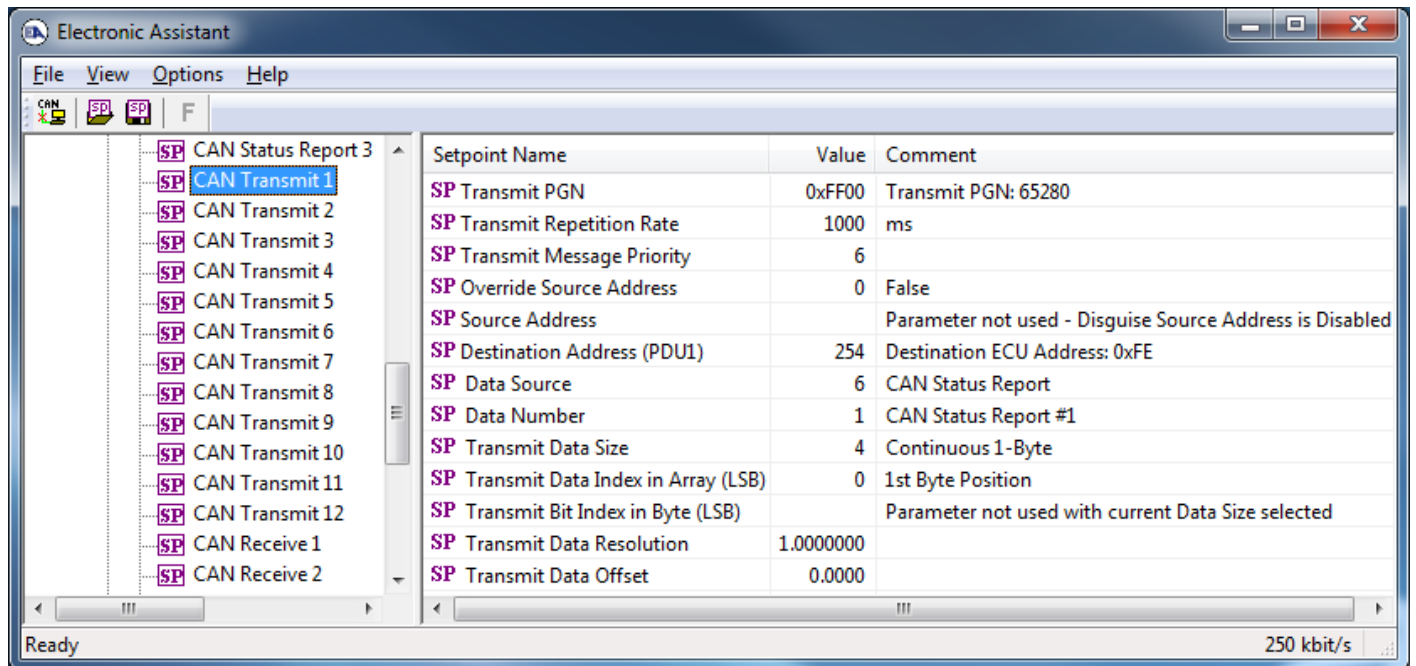

Figure 11: Screen Capture of Default CAN Transmit Setpoints

Table 26: Default CAN Transmit Setpoints

Name	Range	Default	Notes
Transmit Message PGN	0..65,535	65,280	Refer to Section 1.8
Transmit Message Repetition Rate	0..60,000	1000	Refer to Section 1.8
Transmit Message Priority	0..7	6	Refer to Section 1.8
Override Source Address	Drop List	False	
Source Address	0..255	-	Refer to Section 1.8
Destination Address (PDU1)	0..255	254	Refer to Section 1.8
Data Source	Drop List	CAN Status Report	Refer to Table 15

Data Number	Depends on Source Selected	1	Refer to Section 1.8
Transmit Data Size	Drop List	65,280	Refer to Section 1.8
Transmit Data Index in Array (LSB)	Depends on Source Selected	0	Refer to Section 1.8
Transmit Bit Index in Byte (LSB)	Depends on Source Selected	65,280	Refer to Section 1.8
Transmit Data Resolution	-100,000...100,000	1	Refer to Section 1.8
Transmit Data Offset	-100,000...100,000	0	Refer to Section 1.8

3.9. CAN Receive Setpoints

The CAN Receive setpoints are defined in Section 1.7 Refer to that section for detailed information on how these setpoints are used. The screen capture below in Figure 12 displays the available setpoints for the CAN Receive setpoints. Table 27 below highlights the allowable ranges for each setpoint.

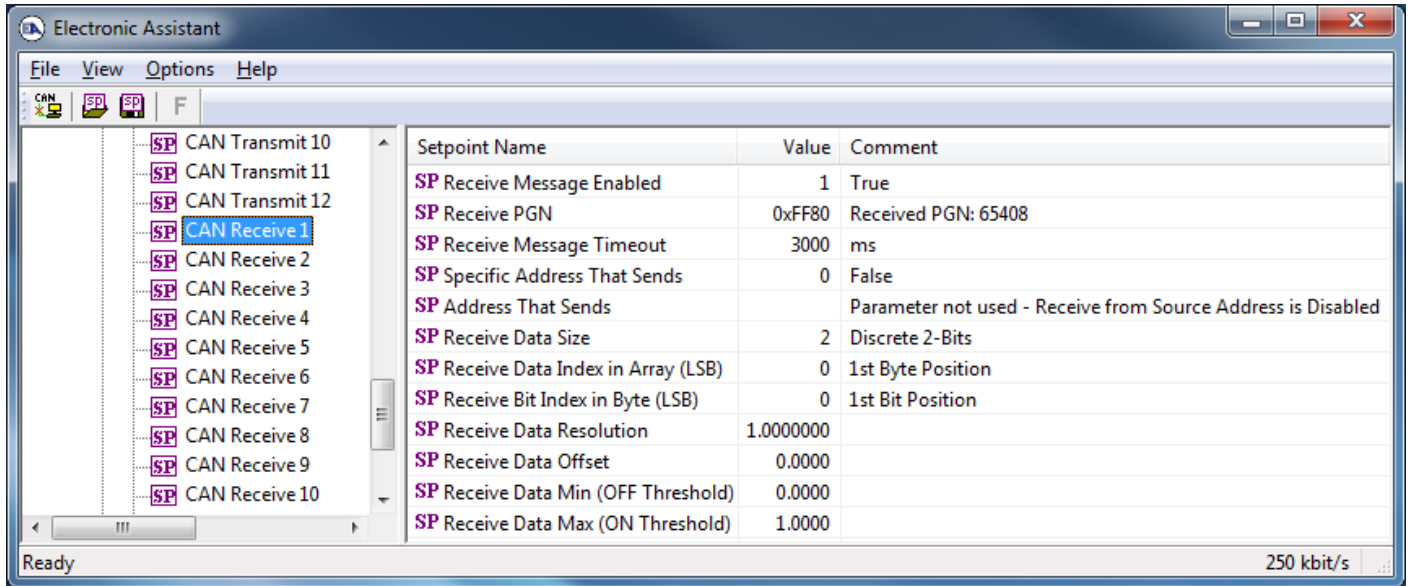

Figure 12: Screen Capture of Default CAN Receive Setpoints

Table 27: Default CAN Receive Setpoints

Name	Range	Default	Notes
Receive Message Enabled	Drop List	False	Default changed to <i>True</i> for illustration purposes. Refer to Section 1.7
Receive PGN	0...65,535	65280	Refer to Section 1.7
Receive Message Timeout	0...60,000	3000	Refer to Section 1.7
Specific Address That Sends	Drop List	False	Refer to Section 1.7
Address That Sends	0...255	255	Not Used by Default
Receive Data Size	Drop List	Discrete 2-Bit	0 = Not Used (disabled) 1 = Discrete 1-Bit 2 = Discrete 2-Bits 3 = Discrete 4-Bits 4 = 1-Byte Continuous 5 = 2-Bytes Continuous

			6 = 4-Bytes Continuous
Receive Data Index in Array (LSB)	0...7	0	Refer to Section 1.7
Receive Bit Index in Byte (LSB)	0...7	0	Refer to Section 1.7
Receive Data Resolution	-0xFFFFFFFF...0xFFFFFFFF	1.0	Refer to Section 1.7
Receive Data Offset	-0xFFFFFFFF...0xFFFFFFFF	0.0	Refer to Section 1.7
Receive Data Min (OFF Threshold)	-0xFFFFFFFF...Data Max	0.0	Refer to Section 1.7
Receive Data Max (ON Threshold)	Data Min...0xFFFFFFFF	1.0	Refer to Section 1.7

3.10. DTC React Setpoints

The DTC React setpoints are defined in subsection 1.5.1. Refer to that subsection for detailed information on how these setpoints are used. The screen capture below in Figure 13 displays the available setpoints for the DTC React setpoints. Table 28 below highlights the allowable ranges for each setpoint.

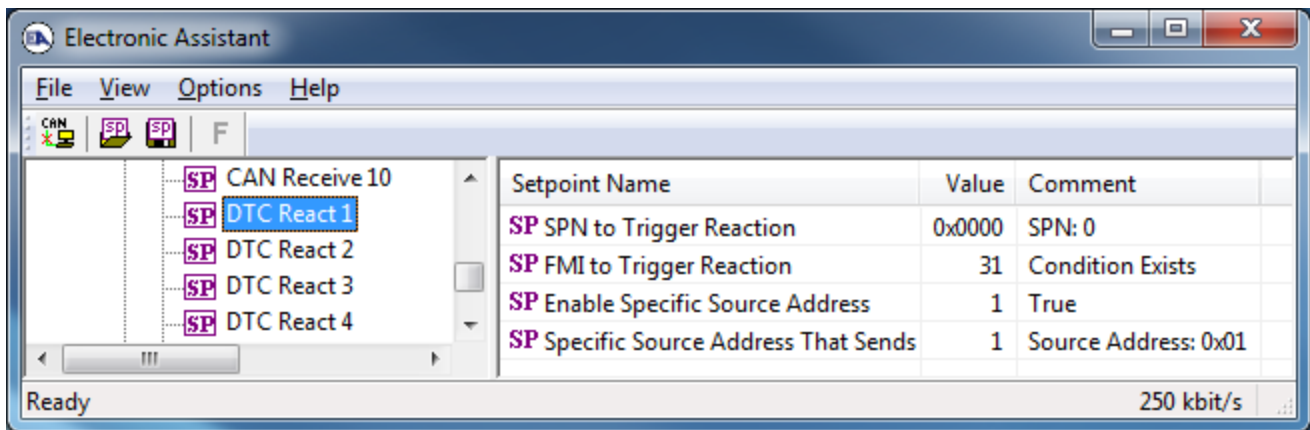

Figure 13: Screen Capture of Default DTC React Setpoints

Table 28: Default DTC React Setpoints

Name	Range	Default	Notes
SPN to Trigger Reaction #1	0...524,287	0	Refer to Section 1.5.1
FMI to Trigger Reaction #1	Drop List	Condition Exists	Refer to Section 1.5.1
Enable Specific Source Address	Drop List	False	Refer to Section 1.5.1
Specific Source Address That Sends	1-253	-	Refer to Section 1.5.1

3.11. Power Supply Diagnostics

The Power Supply Diagnostic setpoints are defined in subsection 1.5.2. Refer to that subsection for detailed information on how these setpoints are used. The screen capture below in Figure 14 displays the available setpoints for the Power Supply Diagnostic setpoints. Table 1 below highlights the allowable ranges for each setpoint.

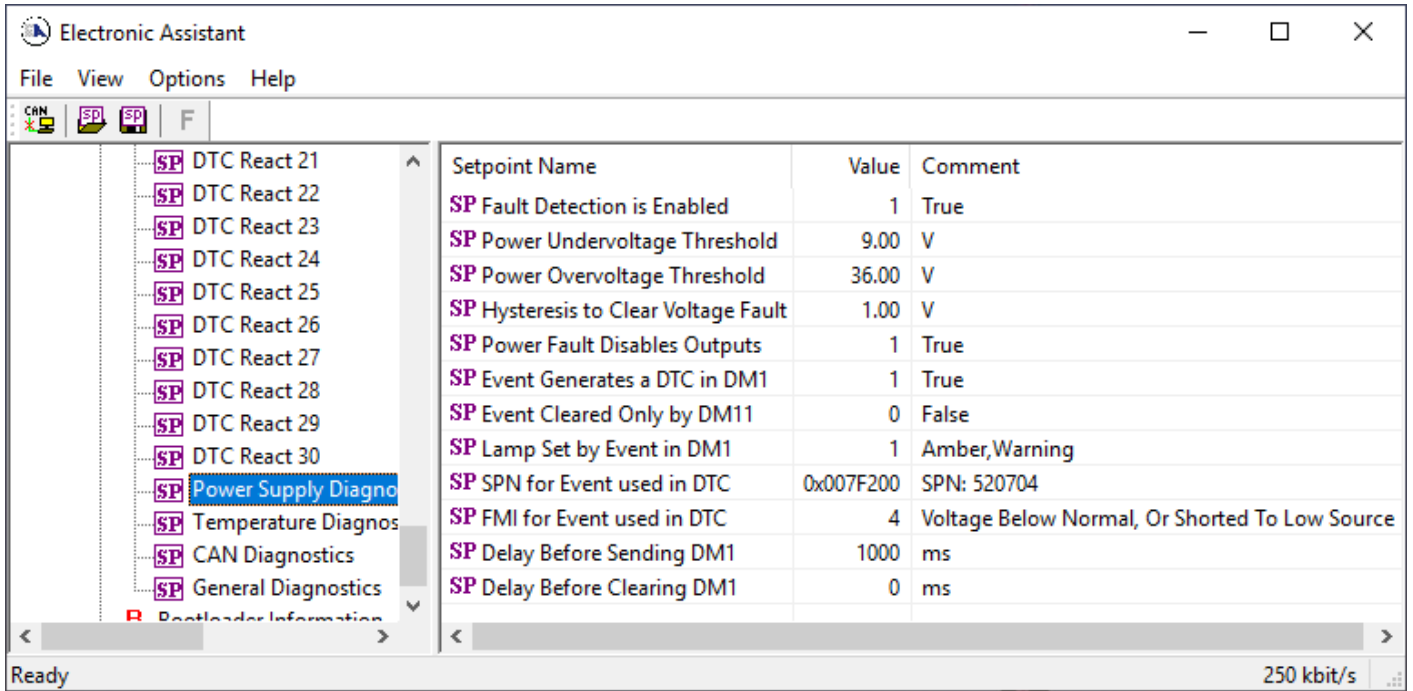

Figure 14: Screen Capture of Default Power Supply Diagnostic Setpoints

Table 29: Default Power Supply Diagnostic Setpoints

Name	Range	Default	Notes
Fault Detection is Enabled	Drop List	True	Refer to Subsection 1.5.2
Power Undervoltage Threshold	8...Power Overvoltage Threshold	9	Units in [volts]
Power Overvoltage Threshold	Power Undervoltage Threshold...36	36	Units in [volts]
Hysteresis to Clear Voltage Fault	0.01...30	1.00	Units in [volts]
Power Fault Disables Outputs	Drop List	True	Refer to Subsection 1.5.2
Event Generates a DTC in DM1	Drop List	False	Default changed to <i>True</i> for illustration purposes, Refer to Subsection 1.5.2
Event Cleared Only by DM11	Drop List	False	Refer to Subsection 1.5.2
Lamp Set by Event in DM1	Drop List	Amber, Warning	Refer to Table 4
SPN for Event used in DTC	0...524,287	520704	Refer to Subsection 1.5.2
FMI for Event used in DTC	Drop List	Voltage Below Normal, Or Shorted to Low Source	Refer to Table 5
Delay Before Sending DM1	0...84,600,000	1000	Units in [milliseconds]
Delay Before Clearing DM1	0...84,600,000	0	If digital output OFF after this time, a DTC will not be sent on a DM1 message anymore.

3.12. Temperature Diagnostics

The Temperature Diagnostic setpoints are defined in subsection 1.5.2. Refer to that subsection for detailed information on how these setpoints are used. The screen capture below in Figure 15

displays the available setpoints for the Temperature Diagnostic setpoints. Table 30 below highlights the allowable ranges for each setpoint.

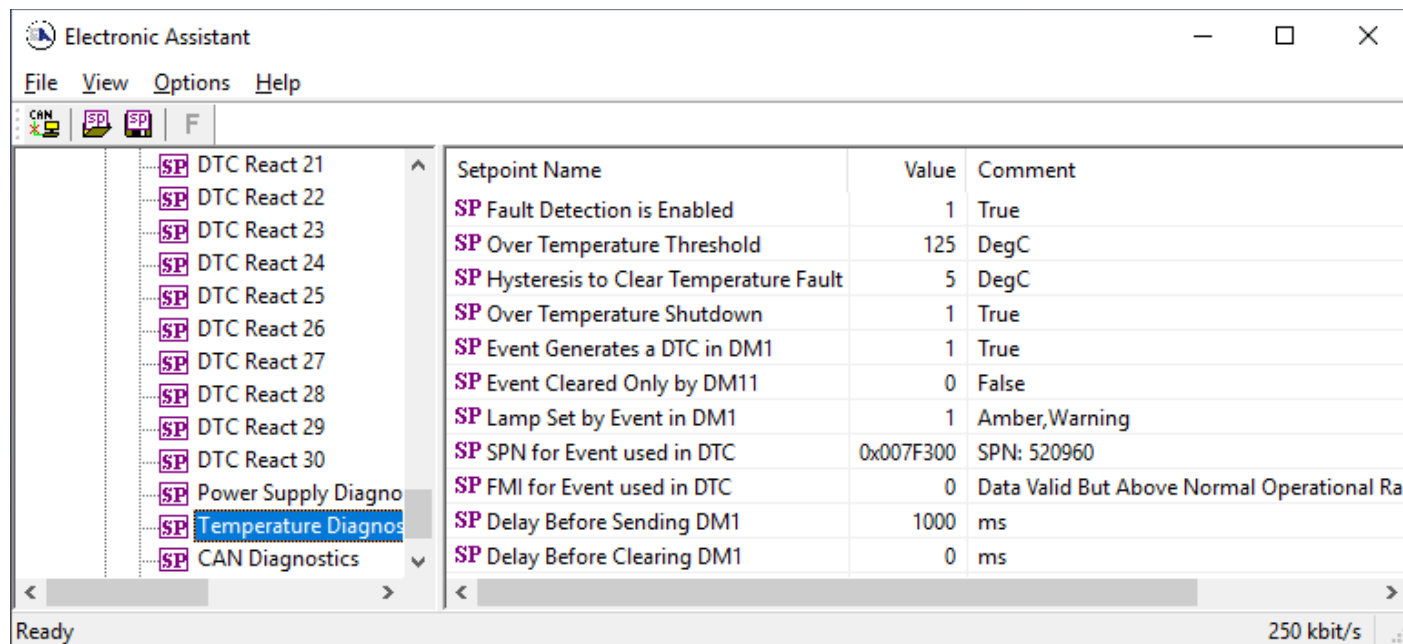

Figure 15: Screen Capture of Default Temperature Diagnostic Setpoints

Table 30: Default Temperature Diagnostic Setpoints

Name	Range	Default	Notes
Fault Detection is Enabled	Drop List	True	Refer to Subsection 1.5.2
Over Temperature Threshold	50...150	125	Units in [degree in C]
Hysteresis to Clear Voltage Fault	1.00...50	5.00	Units in [degree in C]
Over Temperature Shutdown	Drop List	True	Refer to Subsection 1.5.2
Event Generates a DTC in DM1	Drop List	False	Default changed to <i>True</i> for illustration purposes, Refer to Subsection 1.5.2
Event Cleared Only by DM11	Drop List	False	Refer to Subsection 1.5.2
Lamp Set by Event in DM1	Drop List	Amber, Warning	Refer to Table 4
SPN for Event used in DTC	0...524,287	520,960	Refer to Subsection 1.5.2
FMI for Event used in DTC	Drop List	Data Valid But Above Normal Operational Range – Most Severe Level	Refer to Table 5
Delay Before Sending DM1	0...84,600,000	1,000	Units in [milliseconds]
Delay Before Clearing DM1	0...84,600,000	0	If digital output OFF after this time, a DTC will not be sent on a DM1 message anymore.

3.13. CAN Diagnostics

The CAN Diagnostic setpoints are defined in subsection 1.5.2. Refer to that subsection for detailed information on how these setpoints are used. The screen capture below in Figure 16 displays the available setpoints for the Temperature Diagnostic setpoints. Table 31 below highlights the allowable ranges for each setpoint.

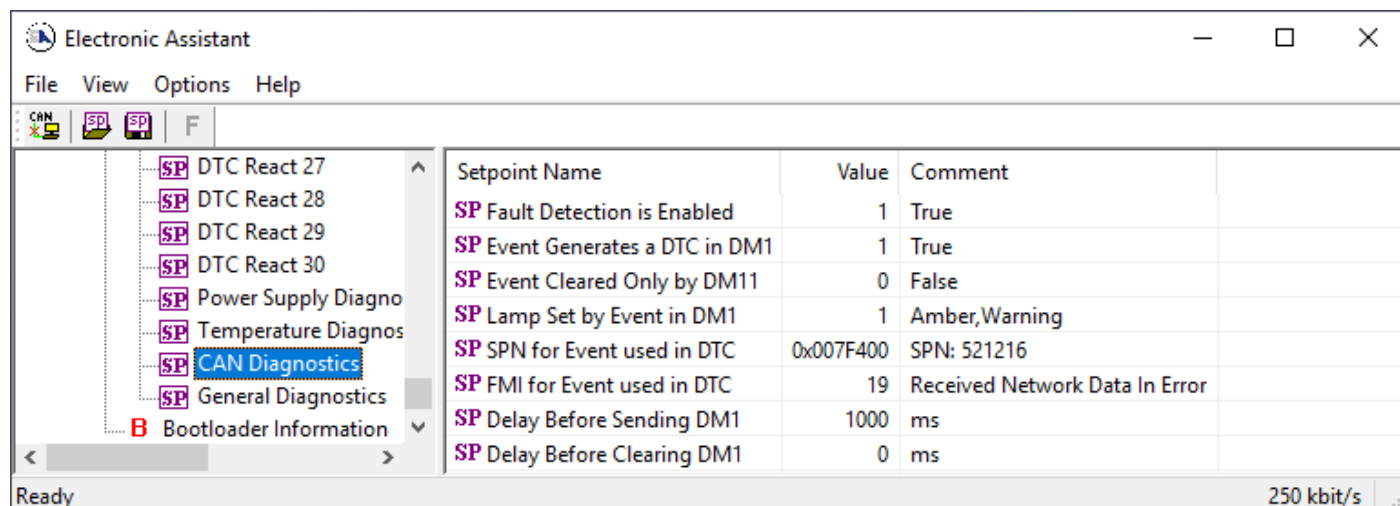

Figure 16: Screen Capture of Default CAN Diagnostic Setpoints

Table 31: Default CAN Diagnostic Setpoints

Name	Range	Default	Notes
Fault Detection is Enabled	Drop List	True	Refer to Subsection 1.5.2
Event Generates a DTC in DM1	Drop List	False	Default changed to <i>True</i> for illustration purposes, Refer to Subsection 1.5.2
Event Cleared Only by DM11	Drop List	False	Refer to Subsection 1.5.2
Lamp Set by Event in DM1	Drop List	Amber, Warning	Refer to Table 4
SPN for Event used in DTC	0...524,287	521,216	Refer to Subsection 1.5.2
FMI for Event used in DTC	Drop List	Voltage Below Normal, Or Shorted to Low Source	Refer to Table 5
Delay Before Sending DM1	0...84,600,000	1,000	Units in [milliseconds]
Delay Before Clearing DM1	0...84,600,000	0	If digital output OFF after this time, a DTC will not be sent on a DM1 message anymore.

3.14. General Diagnostics

The General Diagnostic setpoints are defined in subsection 1.5.1. Refer to that subsection for detailed information on how these setpoints are used. The screen capture below in Figure 17 displays the available setpoints for the Temperature Diagnostic setpoints. Table 32 below highlights the allowable ranges for each setpoint.

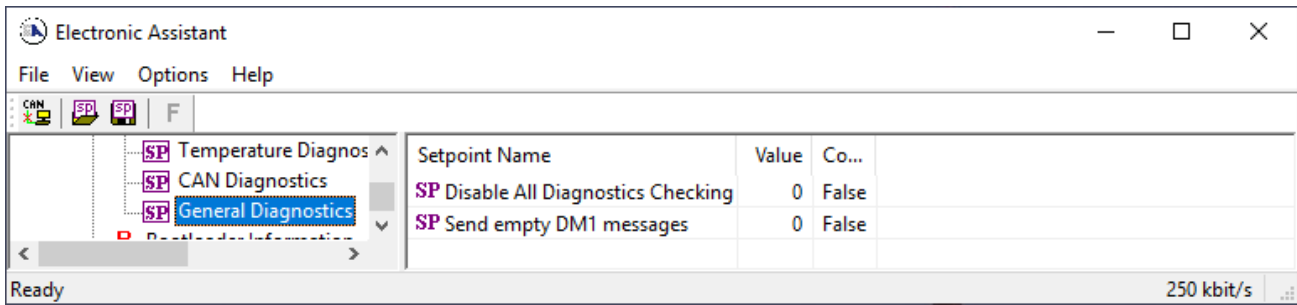

Figure 17: Screen Capture of Default General Diagnostic Setpoints

Table 32: Default General Diagnostic Setpoints

Name	Range	Default	Notes
Disable All Diagnostic Checking	Drop List	False	Refer to Subsection 1.5.1
Send empty DM1 messages	Drop List	False	Refer to Subsection 1.5.1

4. Reflashing over CAN with the Axiomatic Electronic Assistant Bootloader

This chapter describes a procedure of re-programming an application firmware in CANJ1939 in the field.

4.1. Prerequisites

- A personal computer with a USB port running Windows operating system.
- A flash file for P16020 DIO128-ST. It should have the following name: AF-16020-x.xx-sss.bin, where x.xx – firmware version number, and sss are file comments information purposes.
- Axiomatic Electronic Assistant (EA) software.
- Axiomatic CAN Assistant – Scope software, P/N: AX070501SCO.
- Axiomatic USB-CAN Converter, P/N: AX070501. It should be connected to the USB port of the personal computer.
- Power supply to power the controllers.
- Wire harness to connect the controllers to the power supply and to the CAN port of the Axiomatic USB-CAN converter with proper termination resistance.

4.2. Re-flashing Procedure

1. Connect DIO128-ST controller to the power supply and Axiomatic USB-CAN converter.
2. Open CAN port and start monitoring the CAN bus in CAN Assistant – Scope. Make sure that the baud rate is set to 250 kBit/s.
3. Power-up the controller.
4. Run the Axiomatic Electronic Assistant (EA) software and connect to the CAN port. The user should see the following screen:

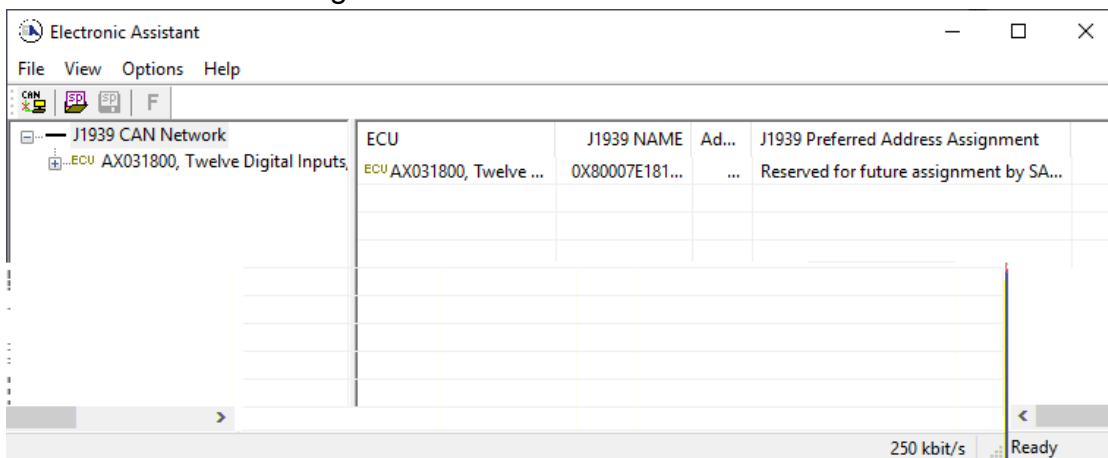

- Click on *Bootloader Information* group in the left panel and then double click on *Force Bootloader to Load on Reset* and another window pops up. Select *OK* to switch to Bootloader Mode.

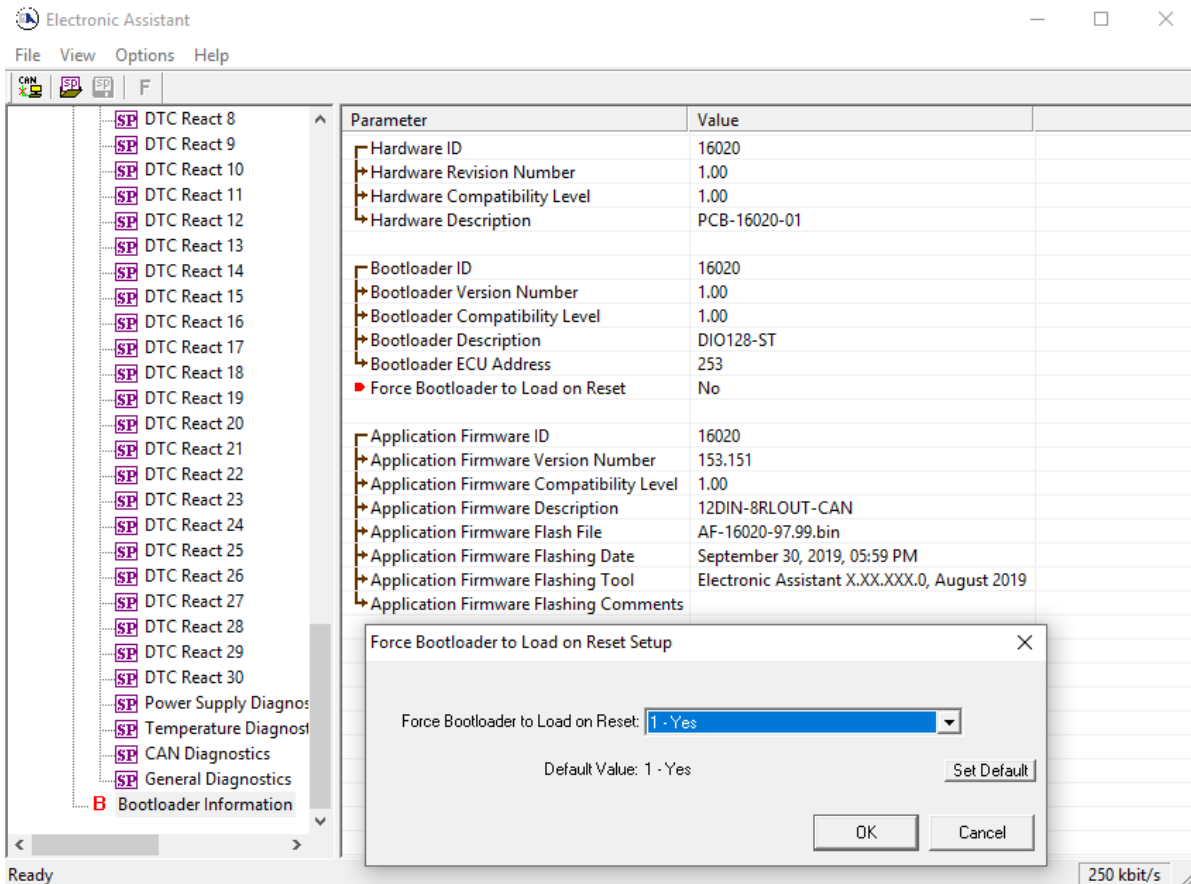

- Click on the *Bootloader Information* group again and then on the **F** button in the Axiomatic EA toolbar. Select the flash file:

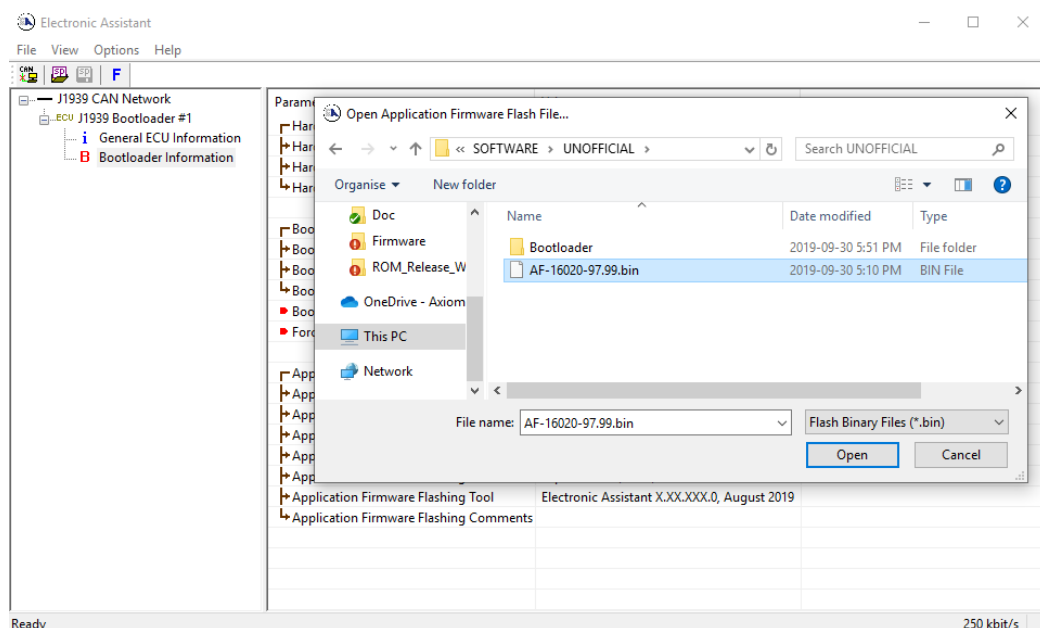

7. Open the flash file and start flashing operation by pressing the *Flash ECU* button. **Make sure Erase All ECU Flash Memory is checked.**

Optionally, the user can write their comments in the *Flashing Comments* field.

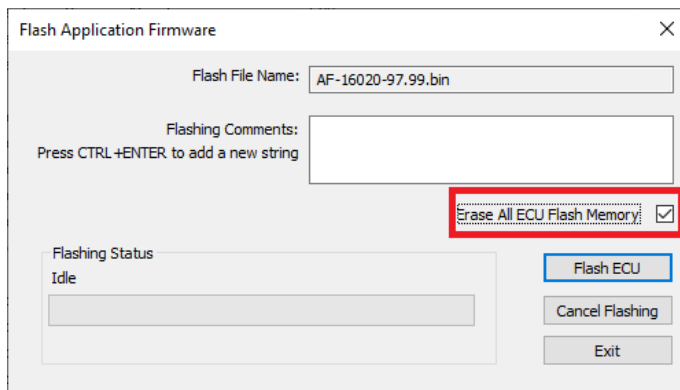

8. Confirm the warning message from the Axiomatic EA.

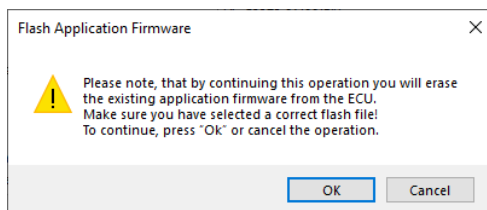

After confirming flashing, the user will see the flashing operation in dynamics on the Axiomatic EA screen.

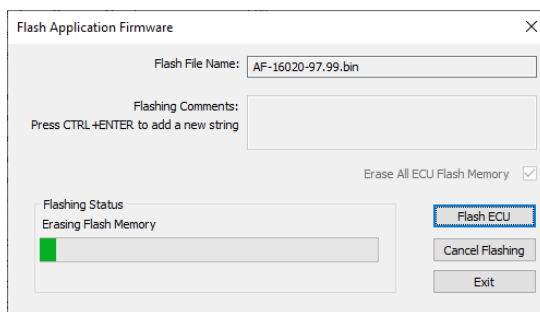

9. When flashing is done, reset the ECU.

The new firmware version should now be running on the unit, which can be reviewed by selecting *Bootloader Information*. The user can check the field *Application Firmware Flash File* to make sure that the uploaded firmware version is running on the unit.

Electronic Assistant

File View Options Help

CAN SP SP F

J1939 CAN Network

- ECU AX031800, Twelve Digital Inputs,
 - General ECU Information
 - Setpoint File
 - Bootloader Information**

Parameter	Value
Hardware ID	16020
Hardware Revision Number	1.00
Hardware Compatibility Level	1.00
Hardware Description	PCB-16020-01
Bootloader ID	16020
Bootloader Version Number	1.00
Bootloader Compatibility Level	1.00
Bootloader Description	DIO128-ST
Bootloader ECU Address	253
Force Bootloader to Load on Reset	No
Application Firmware ID	16020
Application Firmware Version Number	153.151
Application Firmware Compatibility Level	1.00
Application Firmware Description	12DIN-8RLOUT-CAN
Application Firmware Flash File	AF-16020-97.99.bin
Application Firmware Flashing Date	September 30, 2019, 05:59 PM
Application Firmware Flashing Tool	Electronic Assistant X.XX.XXX.0, August 2019
Application Firmware Flashing Comments	

Ready 250 kbit/s

5. INSTALLATION INSTRUCTIONS

5.1. Dimensions and Pinout for AX031800

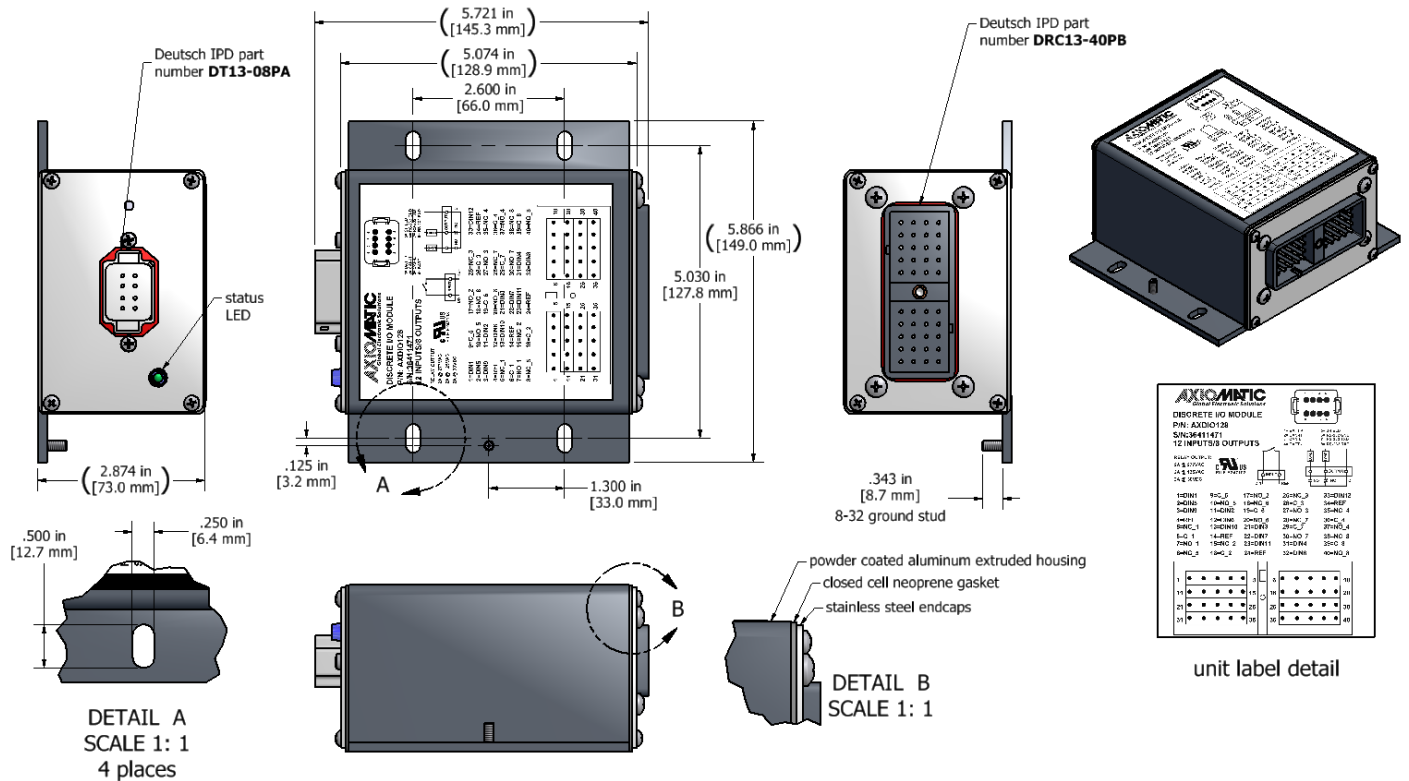

A mating plug kit, P/N: **AX070200**, is available. This kit includes the following items. **NB.** The sealing plugs are only needed in cases where less than the 40 pins are required.

TE Deutsch P/N Equivalent:	Description:
0462-201-16141	48 16AWG SOCKETS SOLID 16-20AWG WIRE 6mm
114017	24 SEALING PLUGS SIZE 12-16 CAVITIES 12-18 AWG
DRC16-40S	40-PIN PLUG, No Key
DT06-08SA	DT SERIES PLUG 8 CONTACT
W8S	WEDGELOCK FOR DT 8 PIN PLUG

These items are also available from a local TE Deutsch distributor.

A crimping tool from TE Deutsch is required to connect wiring to the sockets, P/N: HDT 48-00 or equivalent (not supplied).

Typical Connections – Power and CAN

TE Deutsch P/N: DT13-08PA or Amphenol P/N: AT13-08PA

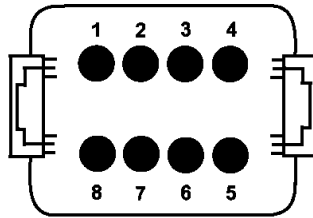

- 1 = PWR+ 5 = SHIELD
- 2 = CAN-H 6 = RS-232 GND
- 3 = CAN-L 7 = RS-232 TXD
- 4 = PWR- 8 = RS-232 RXD

FRONT VIEW
MODULE MOUNTED CONNECTOR
DEUTSCH P/N: DT13-08PA

(Mating plug is DT06-08SA with wedge W8S and sockets 0462-201-16141)

Typical Connections – Inputs and Outputs

FRONT VIEW OF
MODULE MOUNTED CONNECTOR
DEUTSCH P/N: DRC13-40PB

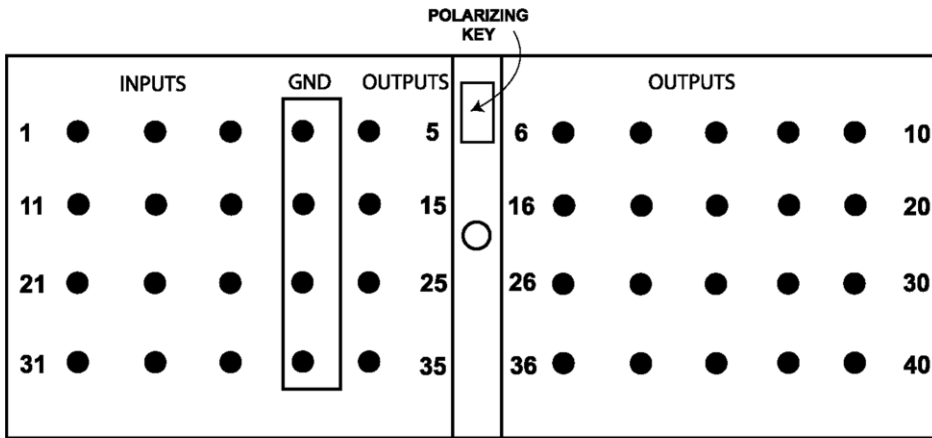

NO - Normally Open
NC - Normally Closed
C - Common

INPUTS	Pin	OUTPUTS	Pin
DIN1	1	NC_1	5
DIN2	11	C_1	6
DIN3	21	NO_1	7
DIN4	31	NC_2	15
DIN5	2	C_2	16
DIN6	12	NO_2	17
DIN7	22	NC_3	25
DIN8	32	C_3	26
DIN9	3	NO_3	27
DIN10	13	NC_4	35
DIN11	23	C_4	36
DIN12	33	NO_4	37
GND	4	NC_5	8
GND	14	C_5	9
GND	24	NO_5	10
GND	34	NC_6	18
		C_6	19
		NO_6	20
		NC_7	28
		C_7	29
		NO_7	30
		NC_8	38
		C_8	39
		NO_8	40

Connections – I/O

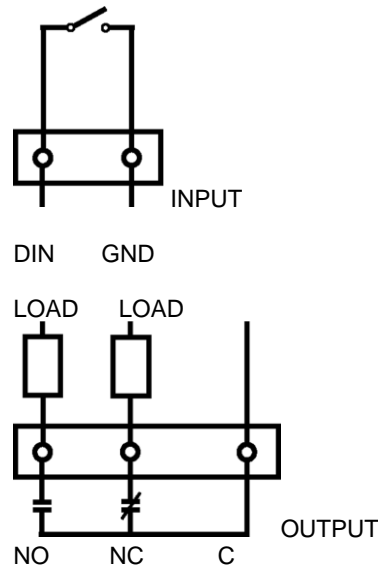

5.2. Dimensions and Pinout for AX031850

The AX031850 series uses a CINCH mini-ME enclosure P/N: 5810130090 with a 40-pin receptacle P/N: 5810140011.

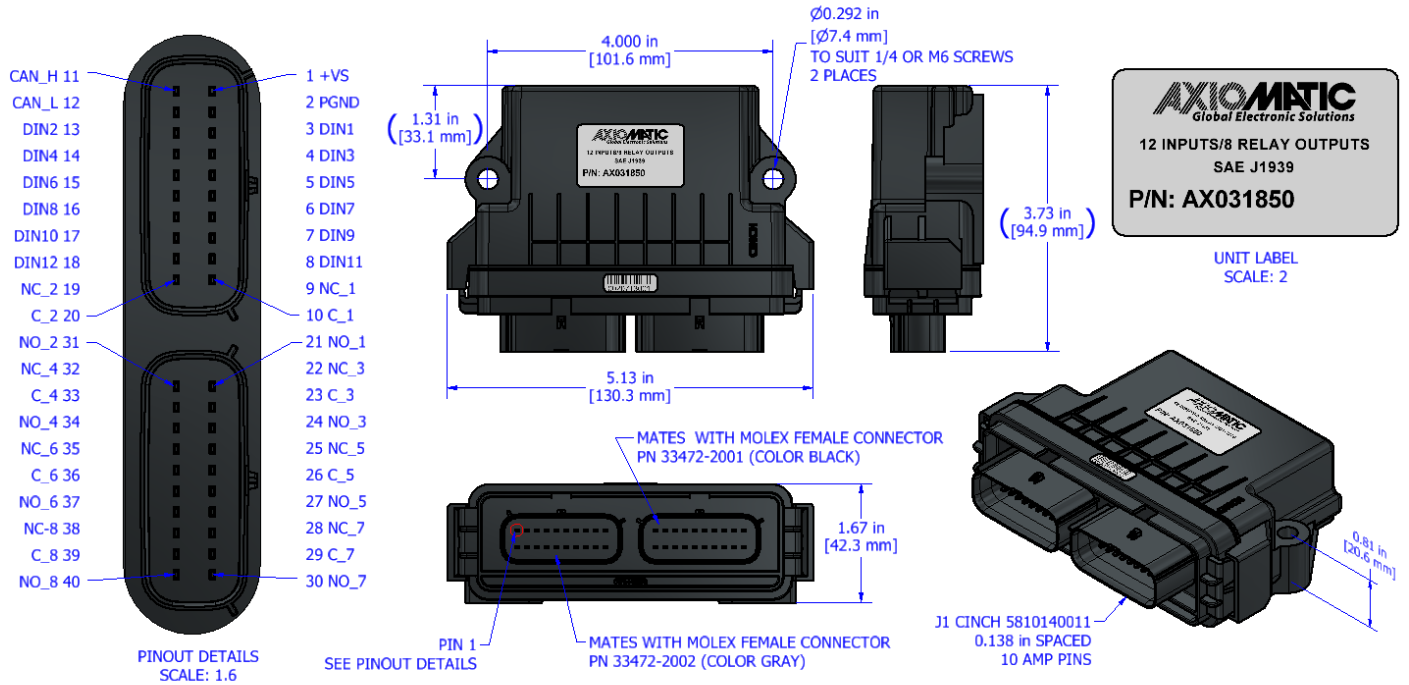

- Mating Plug Kit AX070147:
- 1 Molex 33472-2001 (Key A)
 - 1 Molex 33472-2002 (Key B)
 - 40 Molex 33012-2002 Receptacle Terminals (for crimping) for 18AWG wire
 - 6 Molex 34345-0001 Cavity Plugs
 - To crimp wires onto the receptacle terminals, please use the recommended crimping tools from Molex.

5.3. Installation Instructions

NOTES & WARNINGS

- Do not install near high-voltage or high-current devices.
- Ground the chassis for safety purposes and proper EMI shielding.
- Note the operating temperature range. All field wiring must be suitable for that temperature range.
- Install the unit with appropriate space available for servicing and for adequate wire harness access (15 cm) and strain relief (30 cm).
- Do not connect or disconnect the unit while the circuit is live, unless the area is known to be non-hazardous.

MOUNTING

The module is designed for mounting on the engine. If it is mounted without an enclosure, the DIO should be mounted vertically with connectors facing left and right to reduce likelihood of moisture entry.

The I/O wires and CAN communication cable are considered intrinsically safe. The power wires are not considered intrinsically safe.

Mask all labels if the unit is to be repainted, so label information remains visible.

Mounting ledges include holes sized for M6 or ¼ inch bolts. The bolt length will be determined by the end-user's mounting plate thickness. Typically, 20 mm (3/4 inch) is adequate.

If the module is mounted off-engine, no wire or cable in the harness should exceed 30 meters in length. The power input wiring should be limited to 10 meters.

CONNECTIONS

Use the following TE Deutsch mating plugs to connect to the integral receptacles. Wiring to these mating plugs must be in accordance with all applicable local codes. Suitable field wiring for the rated voltage and current must be used. The rating of the connecting cables must be at least 85°C. Use field wiring suitable for both minimum and maximum ambient temperature.

NOISE – ELECTRICAL CONNECTIONS

To reduce noise, separate all I/O wires from power wires. Shielded I/O wires will protect against ignition and injector noise.

GROUNDING

Protective Earth (PE) must be connected to the module's grounding lug to reduce the risk of electric shock. The conductor providing the connection must have a ring lug and wire larger than or equal to 4 mm² (12 AWG). The ring lug should be placed between the nut and a star washer.

All chassis grounding should go to a single ground point designated for the engine and all related equipment.

The ground strap that provides a low impedance path for EMI should be a ½ inch wide, flat, hollow braid, no more than 12 inches long with a suitable sized ring lug for the module's grounding lug. It may be used in place of the PE grounding conductor and would then perform both PE and EMI grounding functions.

SHIELDING

The I/O and CAN wiring should be shielded using a twisted conductor pair. All I/O wire shields should be terminated on the shield wire available on the 40-pin connector. The I/O wires should not be exposed for more than 50 mm (2 inches) without shielding. The shield may be cut off at the DIO end as it does not require termination at that end.

Shields can be AC grounded at one end and hard grounded at the opposite end to improve shielding effectiveness.

If the module is installed in a cabinet, shielded wiring can be terminated at the cabinet (earth ground), at the entry to the cabinet or at the DIO.

INPUT POWER

The main input to the power supply must be of low-impedance type for proper operation. If batteries are used, an alternator or other battery-charging device is necessary to maintain a stable supply voltage.

Central suppression of any surge events should be provided at the system level.

The installation of the equipment must include overcurrent protection between the power source and the DIO by means of a series connection of properly rated fuses or circuit breakers. Input power switches must be arranged external to the DIO.

The power input wiring should be limited to 10 meters.

Note the operating temperature range. All field wiring must be suitable for that temperature range.

INPUT WIRING

Wiring for the inputs must be shielded cable, 16 or 18 AWG. Cable lengths should be less than 30 meters. Shielding should be unbroken.

CAN WIRING

The CAN port is electrically isolated from all other circuits. The isolation is SELV rated with respect to product safety requirements. Refer to the CAN specification for more information.

Use CAN compatible cabling. J1939 cable is recommended as it is rated for on-engine use.

Shielded CAN cable is required. The DIO provides the CAN port shield connection ac coupled to chassis ground. The chassis ground stud located on the mounting foot must be tied directly to Earth Ground.

FUSING

When installing the unit, an external 3A, 32Vdc fuse is required.

NETWORK CONSTRUCTION

Axiomatic recommends that multi-drop networks be constructed using a “daisy chain” or “backbone” configuration with short drop lines.

TERMINATION

It is necessary to terminate the network. An external CAN termination is required. No more than 2 network terminations are recommended on any one network. Termination is a 121 Ohm, 0.25 W, 1% metal film resistor placed between CAN_H and CAN_L terminals at the end two units on the network.

6. Technical Specifications

Specifications are indicative and subject to change. Actual performance will vary depending on the application and operating conditions. Users should satisfy themselves that the product is suitable for use in the intended application. All our products carry a limited warranty against defects in material and workmanship. Please refer to our Warranty, Application Approvals/ Limitations and Return Materials Process as described on <https://www.axiomatic.com/service/>.

Input

Power Supply Input	12 or 24 VDC nominal (9 to 32 VDC range)
Supply Current	42 mA @ 12 VDC; 23 mA @ 24 VDC typical
Protection	Reverse polarity protection is provided. Power supply input section protects against transient surges and short circuits.
Inputs	Reads twelve discrete inputs (active low with pull-up resistors) Input level characteristics: <ul style="list-style-type: none"> • Low-Level input voltage: 0 to 0.8 V • High-Level input voltage: 3.75 V to +BAT • Inputs have internal pull-up resistors. • Input resistance: more than 5 kΩ The inputs have internal over and under voltage protection.

Output

Outputs	<p>AX031800: Sets 8 Form C relay outputs. Resistive load:</p> <ul style="list-style-type: none"> • 2A (NO)/2 A (NC) at 277 VAC • 2 A (NO)/2 A (NC) at 125 VAC • 2 A (NO)/2 A (NC) at 30 VDC <p>Dielectric strength:</p> <ul style="list-style-type: none"> • 4,000 VAC, 50/60 Hz for 1 min between coil and contacts • 750 VAC, 50/60 Hz for 1 min between contacts of same polarity <p>There is no special overcurrent/overvoltage protection on the relay outputs. The user is advised to provide a fast-acting 3 A fuse or adequate external protection if necessary.</p> <p>AX031850: Sets 8 Form C relay outputs. Resistive load:</p> <ul style="list-style-type: none"> • 5A (NO)/5 A (NC) at 30 VDC <p>Dielectric strength:</p> <ul style="list-style-type: none"> • 4,000 VAC, 50/60 Hz for 1 min between coil and contacts • 750 VAC, 50/60 Hz for 1 min between contacts of same polarity <p>There is no special overcurrent/overvoltage protection on the relay outputs. The user is advised to provide a fast-acting 6A fuse or an adequate external protection if necessary.</p>
---------	---

Communication

CAN	Bosch CAN protocol specification, Rev.2.0, Part A and B. Baud Rate: AX031800, AX031850: 250 bit/sec AX031800-01, AX031850-01: 500 bit/sec AX031800-02, AX031850-02: 1000 bit/sec. Other requirements – according to SAE J1939 standard.
RS-232	AX031800: For Axiomatic use only.

General Specifications

Microcontroller	STM32F405RG
Control Logic	User programmable functionality using the Axiomatic Electronic Assistant KIT, P/Ns: AX070502 or AX070506K
Indicator	Front panel Red-Green Bi-LED indicator. (Only available for AX031800)
SAE J1939 Profile	For J1939 compliance (SAE, Recommended Practice for a Serial Control and Communications Vehicle Network, October 2007) all modules comply with the applicable portions of the following: <ul style="list-style-type: none"> • SAE J1939-21, Dec 2006, Data Link Layer • SAE J1939-71, Sep 2013, Application Layer • SAE J1939-73, Feb 2010, Application Layer – Diagnostic • SAE J1939-81, March 2017, Network Management <i>Customer specific proprietary extensions can also be included in the SAE J1939 profile on request.</i>
User Interface	Axiomatic Electronic Assistant KIT, P/Ns: AX070502, or AX070506K Updates for the Axiomatic EA are found on www.axiomatic.com under the log-in tab.
Operating Temperature	-40 to 85 °C (-40 to 185 °F)
Storage Temperature	-50 to 120 °C (-58 to 248 °F)

UL and cUL Compliance	AX031800: Standard for Controllers for Use in Power Production, CAN/ULC 6200, 1 st edition
CE/UKCA Compliance	2004/108/EC (EMC Directive) 2011/65/EU (RoHS Directive)
Marine Type Approval	AX031800: ABS, CCS, LR
Humidity	Protected against 95% humidity non-condensing, 30 °C to 60 °C
Protection	AX031800: IP67 AX031850: IP67 and IP69K
Weight	AX031800: 2.73 lb. (1.24 kg) AX031850: 0.45 lb. (0.204 kg)
Vibration	AX031800: Vibration: 4.3 G for off-engine mounting AX031850: Vibration: MIL-STD-202G, Test 204D and 214A (Sine and Random); 10 g peak (Sine); 7.86 Grms peak (Random) Shock: MIL-STD-202G, Test 213B, 50 g
Enclosure	Refer to Installation Instructions for dimensions. AX031800 Series: Rugged aluminum housing, stainless steel end plates, neoprene gaskets Conformal coated PCB assemblies and partially encapsulated AX031850 Series: Rugged CINCH mini-ME enclosure P/N: 5810130090 and 40-pin receptacle P/N: 5810140011
Discrete I/O Wiring - Typical	<p>12 - 24 Vdc External Supply (-) (+)</p> <p>J1939 Comms</p> <p>DISCRETE I/O MODULE</p> <p>INPUT #1 DI01 DIA (return#1)</p> <p>External Switch</p> <p>INPUT #7 DI07 DIB (return#2)</p> <p>External Switch</p> <p>DO1com</p> <p>EXTERNAL LOAD (LAMP, RELAY, etc)</p> <p>12-24VDC OR 120-277VAC External Supply</p> <p>DO1a DO1b</p> <p>OUTPUT #1</p> <p>Note: Inputs #2-6, #8-12 Outputs #2-8 Not shown</p>

VERSION HISTORY

Version	Date	Author	Modifications
1.00	January 15, 2019	Erik Sasse	Initial Draft
2.00	April 24, 2019	Erik Sasse	- Add drawings of AX031850 - Rename User Manual
3.00	August 13, 2019	Erik Sasse	- Add new feature "Conditional Block" - Increase amount of Diagnostic Trouble Code messages
-	August 19, 2019	Amanda Wilkins	Marketing Review - Added weight for AX03185X and vibration compliance for AX03180X
4.00	October 15, 2019	Erik Sasse	- Increased amount of CAN Receives to 16 - Add support Constant Data - Add instructions for re-flashing
-	July 29, 2020	Amanda Wilkins	- Added vibration compliance for AX03185X and CE marking
5.00	June 20, 2022	Sabrina Tang	- Added CE marking for EMC, UL compliance, and Amphenol 8-pin connector
5.01	June 22, 2023	M Ejaz	Fixed legacy issues
5.02	July 12, 2023	M Ejaz	Updated Technical Specifications
5.03	August 1, 2023	Kiril Mojsov	Performed Further Legacy Updates
5.04	February 1, 2024	M Ejaz	Corrected typo on the title page

OUR PRODUCTS

AC/DC Power Supplies
Actuator Controls/Interfaces
Automotive Ethernet Interfaces
Battery Chargers
CAN Controls, Routers, Repeaters
CAN/WiFi, CAN/Bluetooth, Routers
Current/Voltage/PWM Converters
DC/DC Power Converters
Engine Temperature Scanners
Ethernet/CAN Converters,
Gateways, Switches
Fan Drive Controllers
Gateways, CAN/Modbus, RS-232
Gyroscopes, Inclinometers
Hydraulic Valve Controllers
Inclinometers, Triaxial
I/O Controls
LVDT Signal Converters
Machine Controls
Modbus, RS-422, RS-485 Controls
Motor Controls, Inverters
Power Supplies, DC/DC, AC/DC
PWM Signal Converters/Isolators
Resolver Signal Conditioners
Service Tools
Signal Conditioners, Converters
Strain Gauge CAN Controls
Surge Suppressors

OUR COMPANY

Axiomatic provides electronic machine control components to the off-highway, commercial vehicle, electric vehicle, power generator set, material handling, renewable energy and industrial OEM markets. ***We innovate with engineered and off-the-shelf machine controls that add value for our customers.***

QUALITY DESIGN AND MANUFACTURING

We have an ISO9001:2015 registered design/manufacturing facility in Canada.

WARRANTY, APPLICATION APPROVALS/LIMITATIONS

Axiomatic Technologies Corporation reserves the right to make corrections, modifications, enhancements, improvements, and other changes to its products and services at any time and to discontinue any product or service without notice. Customers should obtain the latest relevant information before placing orders and should verify that such information is current and complete. Users should satisfy themselves that the product is suitable for use in the intended application. All our products carry a limited warranty against defects in material and workmanship. Please refer to our Warranty, Application Approvals/Limitations and Return Materials Process at <https://www.axiomatic.com/service/>.

COMPLIANCE

Product compliance details can be found in the product literature and/or on axiomatic.com. Any inquiries should be sent to sales@axiomatic.com.

SAFE USE

All products should be serviced by Axiomatic. Do not open the product and perform the service yourself.



This product can expose you to chemicals which are known in the State of California, USA to cause cancer and reproductive harm. For more information go to www.P65Warnings.ca.gov.

SERVICE

All products to be returned to Axiomatic require a Return Materials Authorization Number (RMA#) from rma@axiomatic.com. Please provide the following information when requesting an RMA number:

- Serial number, part number
- Runtime hours, description of problem
- Wiring set up diagram, application and other comments as needed

DISPOSAL

Axiomatic products are electronic waste. Please follow your local environmental waste and recycling laws, regulations and policies for safe disposal or recycling of electronic waste.

CONTACTS

Axiomatic Technologies Corporation
1445 Courtneypark Drive E.
Mississauga, ON
CANADA L5T 2E3
TEL: +1 905 602 9270
FAX: +1 905 602 9279
www.axiomatic.com
sales@axiomatic.com

Axiomatic Technologies Oy
Höytämöntie 6
33880 Lempäälä
FINLAND
TEL: +358 103 375 750
www.axiomatic.com
salesfinland@axiomatic.com