

# **12 Input, 12 Output Valve Controller**

## **With CANopen®**

### **USER MANUAL**

**P/N: AX020421**

## ACRONYMS

<b>AI</b>	Analog Input
<b>AO</b>	Analog Output
<b>CAN</b>	Controller Area Network
<b>CANopen®</b>	CANopen® is a registered community trademark of CAN in Automation e.V.
<b>CAN-ID</b>	CAN 11-bit Identifier
<b>COB</b>	Communication Object
<b>CTRL</b>	Control
<b>DI</b>	Digital Input
<b>DO</b>	Digital Output
<b>EDS</b>	Electronic Data Sheet
<b>EMCY</b>	Emergency
<b>LSB</b>	Least Significant Byte (or Bit)
<b>LSS</b>	Layer Settling Service
<b>LUT</b>	Lookup Table
<b>MI</b>	Magnetic Input
<b>MSB</b>	Most Significant Byte (or Bit)
<b>NMT</b>	Network Management
<b>PID</b>	Proportional-Integral-Derivative Control
<b>RLYO</b>	Relay Output
<b>RO</b>	Read Only Object
<b>RPDO</b>	Received Process Data Object
<b>RW</b>	Read/Write Object
<b>SDO</b>	Service Data Object
<b>TPDO</b>	Transmitted Process Data Object
<b>UI</b>	Universal Input
<b>VO</b>	Valve Output (Universal)
<b>WO</b>	Write Only Object

## REFERENCES

- [DS-301] CiA DS-301 V4.1 – CANopen® Application Layer and Communication Profile. CAN in Automation 2005
- [DS-305] CiA DS-305 V2.0 – Layer Setting Service (LSS) and Protocols. CAN in Automation 2006
- [DS-404] CiA DS-404 V1.2 – CANopen® profile for Measurement Devices and Closed Loop Controllers. CAN in Automation 2002

These documents are available from the CAN in Automation e.V. website: <http://www.can-cia.org/>.

# TABLE OF CONTENTS

<b>1. OVERVIEW OF CONTROLLER</b> .....	<b>8</b>
<b>1.1. DESCRIPTION OF I/O CONTROLLER</b> .....	<b>8</b>
<b>1.2. DIGITAL INPUT FUNCTION BLOCK</b> .....	<b>9</b>
<b>1.3. INPUT FUNCTION BLOCK</b> .....	<b>12</b>
<b>1.4. DIGITAL OUTPUT FUNCTION BLOCK</b> .....	<b>18</b>
<b>1.5. ANALOG OUTPUT FUNCTION BLOCK</b> .....	<b>21</b>
<b>1.6. AVAILABLE CONTROL SOURCES</b> .....	<b>23</b>
<b>1.7. PID CONTROL FUNCTION BLOCK</b> .....	<b>32</b>
<b>1.8. LOOKUP TABLE FUNCTION BLOCK</b> .....	<b>34</b>
1.8.1. X-Axis, Input Data Response.....	35
1.8.2. Y-Axis, Lookup Table Output .....	35
1.8.3. Point To Point Response .....	35
1.8.4. X-Axis, Time Response.....	37
<b>1.9. PROGRAMMABLE LOGIC FUNCTION BLOCK</b> .....	<b>38</b>
Conditions Evaluation.....	40
1.9.1. Table Selection .....	41
1.9.2. Logic Block Output .....	43
<b>1.10. MATH FUNCTION BLOCK</b> .....	<b>43</b>
<b>1.11. CONDITIONAL LOGIC BLOCK</b> .....	<b>46</b>
<b>1.12. SET-RESET LATCH FUNCTION BLOCK</b> .....	<b>47</b>
<b>1.13. MISCELLANEOUS FUNCTION BLOCK</b> .....	<b>48</b>
<b>1.14. DIMENSIONS AND PINOUT</b> .....	<b>50</b>
<b>2. CANOPEN ® OBJECT DICTIONARY</b> .....	<b>52</b>
<b>2.1. NODE ID AND BAUDRATE</b> .....	<b>52</b>
2.1.1. LSS Protocol to Update.....	52
<b>2.2. COMMUNICATION OBJECTS (DS-301 AND DS-404)</b> .....	<b>56</b>
2.2.1. Object 1000h: Device Type .....	57
2.2.2. Object 1001h: Error Register.....	57
2.2.3. Object 1002h: Manufacturer Status Register.....	58
2.2.4. Object 1003h: Pre-Defined Error Field .....	58
2.2.5. Object 100Ch: Guard Time .....	59
2.2.6. Object 100Dh: Lifetime Factor .....	60
2.2.7. Object 1010h: Store Parameters.....	60
2.2.8. Object 1011h: Restore Parameters.....	62
2.2.9. Object 1016h: Consumer Heartbeat Time .....	63
2.2.10. Object 1017h: Producer Heartbeat Time .....	64
2.2.11. Object 1018h: Identity Object.....	64
2.2.12. Object 1020h: Verify Configuration .....	65
2.2.13. Object 1029h: Error Behaviour .....	66
2.2.14. RPDO Behaviour .....	68
2.2.15. TPDO Behaviour .....	70
<b>2.3. APPLICATION OBJECTS (DS-404)</b> .....	<b>73</b>
2.3.1. Object 6000h: DI Read State 8 Input Lines.....	74
2.3.2. Object 6002h: DI Polarity 8 Input Lines.....	74
2.3.3. Object 7100h: AI Input Field Value.....	75
2.3.4. Object 6110h: AI Sensor Type .....	75
2.3.5. Object 6112h: AI Operating Mode .....	76
2.3.6. Object 7120h: AI Input Scaling 1 FV .....	77
2.3.7. Object 7121h: AI Input Scaling 1 PV .....	77
2.3.8. Object 7122h: AI Input Scaling 2 FV .....	78
2.3.9. Object 7123h: AI Input Scaling 2 PV .....	78
2.3.10. Object 7130h: AI Input Process Value .....	79
2.3.11. Object 6132h: AI Decimal Digits PV.....	79
2.3.12. Object 7148h: AI Span Start .....	80
2.3.13. Object 7149h: AI Span End .....	80
2.3.14. Object 61A0h: AI Filter Type .....	81

2.3.15.	Object 61A1h: AI Filter Constant.....	82
2.3.16.	Object 6200h: DO Write State 8 Output Lines .....	82
2.3.17.	Object 6202h: DO Polarity 8 Output Lines .....	83
2.3.18.	Object 6206h: DO Fault Mode 1 Output Line.....	83
2.3.19.	Object 6207h: DO Fault State 1 Output Line.....	84
2.3.20.	Object 7300h: AO Output Process Value .....	85
2.3.21.	Object 6302h: AO Decimal Digits PV .....	85
2.3.22.	Object 6310h: AO Output Type .....	86
2.3.23.	Object 7320h: AO Output Scaling 1 PV .....	86
2.3.24.	Object 7321h: AO Output Scaling 1 FV.....	87
2.3.25.	Object 7322h: AO Output Scaling 2 PV .....	88
2.3.26.	Object 7323h: AO Output Scaling 2 FV.....	88
2.3.27.	Object 7330h: AO Output Field Value.....	89
2.3.28.	Object 6332h: AO Decimal Digits FV .....	89
2.3.29.	Object 6340h: AO Fault Mode.....	90
2.3.30.	Object 7341h: AO Fault Field Value .....	91
2.3.31.	Object 7450h: PID Proportional Band .....	91
2.3.32.	Object 7452h: PID Integral Action Time .....	92
2.3.33.	Object 7454h: PID Derivative Action Time .....	92
2.3.34.	Object 7456h: PID Cycle Time .....	93
2.3.35.	Object 6458h: PID Physical Unit Timing .....	93
2.3.36.	Object 6459h: PID Decimal Digits Timing.....	94
<b>2.4.</b>	<b>MANUFACTURER OBJECTS.....</b>	<b>95</b>
2.4.1.	Object 2020h: DI Pullup/Down Mode 1 Input Line .....	97
2.4.2.	Object 2030h: DI Debounce Filter 1 Input Line .....	97
2.4.3.	Object 2100h: AI Input Range .....	98
2.4.4.	Object 2101h: AI Number of Pulses Per Revolution.....	99
2.4.5.	Object 2102h: AI Decimal Digits FV.....	99
2.4.6.	Object 2103h: AI Filter Frequency for ADC .....	100
2.4.7.	Object 2110h: AI Error Detect Enable .....	101
2.4.8.	Object 2111h: AI Error Clear Hysteresis.....	101
2.4.9.	Object 2112h: AI Error Reaction Delay.....	102
2.4.10.	Object 2120h: AI Third-Order Filter Power .....	102
2.4.11.	Object 2121h: AI Third-Order Filter Input Coefficient N0 .....	103
2.4.12.	Object 2122h: AI Third-Order Filter Input Coefficient N1 .....	103
2.4.13.	Object 2123h: AI Third-Order Filter Input Coefficient N2 .....	103
2.4.14.	Object 2124h: AI Third-Order Filter Input Coefficient N3 .....	103
2.4.15.	Object 2125h: AI Third-Order Filter Output Coefficient N1 .....	104
2.4.16.	Object 2126h: AI Third-Order Filter Output Coefficient N2 .....	104
2.4.17.	Object 2127h: AI Third-Order Filter Output Coefficient N3 .....	104
2.4.18.	Object 2220h: DO Hotshot Current 1 Output Line .....	104
2.4.19.	Object 2221h: DO Hold Current 1 Output Line .....	105
2.4.20.	Object 2222h: DO Hold Time 1 Output Line.....	105
2.4.21.	Object 2223h: DO Blink Rate.....	106
2.4.22.	Object 2224h: DO Delay Time 1 Output Line .....	107
2.4.23.	Object 2225h: DO Delay Polarity 1 Output Line.....	107
2.4.24.	Object 2230h: DO Output Status.....	108
2.4.25.	Object 2300h: AO Override Field Value .....	108
2.4.26.	Object 2310h: AO Error Detect Enable .....	109
2.4.27.	Object 2311h: AO Error Clear Hysteresis .....	109
2.4.28.	Object 2312h: AO Error Reaction Delay .....	110
2.4.30.	Object 2321h: AO Dither Amplitude .....	111
2.4.31.	Object 2330h: AO Ramp Up .....	112
2.4.32.	Object 2331h: AO Ramp Down .....	112
2.4.33.	Object 2340h: AO Control Input Source.....	113
2.4.34.	Object 2341h: AO Control Input Number .....	114
2.4.35.	Object 2342h: AO Control Response.....	114
2.4.36.	Object 2350h: AO Enable Input Source.....	115

2.4.37.	Object 2351h: AO Enable Input Number.....	116
2.4.38.	Object 2352h: AO Enable Response.....	116
2.4.39.	Object 2360h: AO Override Input Source.....	117
2.4.40.	Object 2361h: AO Override Input Number.....	117
2.4.41.	Object 2362h: AO Override Response.....	118
2.4.42.	Object 2370h: AO Feedback Field Value.....	119
2.4.43.	Object 2371h: AO Feedback Current Field Value.....	119
2.4.44.	Object 2380h: AO Output Frequency.....	120
2.4.45.	Object 2382h: AO Current PID Proportional Gain.....	121
2.4.46.	Object 2383h: AO Current PID Integral Time.....	121
2.4.47.	Object 2384h: AO Current PID Derivative Time.....	122
2.4.48.	Object 2450h: PID Tolerance.....	122
2.4.49.	Object 2451h: PID Integral Gain.....	123
2.4.50.	Object 2452h: PID Derivative Gain.....	123
2.4.51.	Object 2453h: PID Target Source.....	124
2.4.52.	Object 2454h: PID Target Number.....	125
2.4.53.	Object 2455h: PID Feedback Source.....	125
2.4.54.	Object 2456h: PID Feedback Number.....	126
2.4.55.	Object 2457h: PID Control Response.....	126
2.4.56.	Object 2460h: PID Output Field Value.....	127
2.4.57.	Object 2500h: EC Extra Received Process Value.....	128
2.4.58.	Object 2502h: EC Decimal Digits PV.....	128
2.4.59.	Object 2520h: EC Scaling 1 PV.....	129
2.4.60.	Object 2522h: EC Scaling 2 PV.....	129
2.4.61.	Object 3yz0h: LTyz Input X-Axis Source.....	130
2.4.62.	Object 3yz1h: LTyz Input X-Axis Number.....	130
2.4.63.	Object 3yz2h: LTyz Auto Repeat.....	131
2.4.64.	Object 3yz3h: LTyz X-Axis Decimal Digits PV.....	131
2.4.65.	Object 3yz4h: LTyz Y-Axis Decimal Digits PV.....	132
2.4.66.	Object 3yz5h: LTyz Point Response.....	132
2.4.67.	Object 3yz6h: LTyz Point X-Axis PV.....	133
2.4.68.	Object 3yz7h: LTyz Point Y-Axis PV.....	134
2.4.69.	Object 3yz8h: LTyz Output Y-Axis PV.....	134
2.4.70.	Object 3300h: Logic Block Enable.....	135
2.4.71.	Object 3310h: Logic Block Selected Table.....	135
2.4.72.	Object 3320h: Logic Block Output PV.....	136
2.4.73.	Object 3x01h: LB(x-3) Lookup Table Numbers.....	136
2.4.74.	Object 3x02h: LB(x-3) Function Logical Operator.....	137
2.4.75.	Object 3x11h: LB(x-3) Function A Condition 1.....	137
2.4.76.	Object 3x12h: LB(x-3) Function A Condition 2.....	137
2.4.77.	Object 3x13h: LB(x-3) Function A Condition 3.....	137
2.4.78.	Object 3x21h: LB(x-3) Function B Condition 1.....	137
2.4.79.	Object 3x22h: LB(x-3) Function B Condition 2.....	137
2.4.80.	Object 3x23h: LB(x-3) Function B Condition 3.....	137
2.4.81.	Object 3x31h: LB(x-3) Function C Condition 1.....	137
2.4.82.	Object 3x32h: LB(x-3) Function C Condition 2.....	137
2.4.83.	Object 3x33h: LB(x-3) Function C Condition 3.....	137
2.4.84.	Object 3900h: Set-Reset Latch Enable.....	139
2.4.85.	Object 3910h: Set-Reset Latch Output Process Value.....	139
2.4.86.	Object 39x1h: Set-Reset Latch [x] Reset Signal Source.....	140
2.4.87.	Object 39x2h: Set-Reset Latch [x] Reset Signal Number.....	140
2.4.88.	Object 39x3h: Set-Reset Latch [x] Reset Signal OFF Threshold.....	140
2.4.89.	Object 39x4h: Set-Reset Latch [x] Reset Signal ON Threshold.....	141
2.4.90.	Object 39x5h: Set-Reset Latch [x] Set Signal Source.....	141
2.4.91.	Object 39x6h: Set-Reset Latch [x] Set Signal Number.....	141
2.4.92.	Object 39x7h: Set-Reset Latch [x] Set Signal OFF Threshold.....	142
2.4.93.	Object 39x8h: Set-Reset Latch [x] Set Signal ON Threshold.....	142
2.4.94.	Object 4000h: Math Function Enable.....	142

- 2.4.95. Object 4021h: Math Output Scaling 1 PV..... 143
- 2.4.96. Object 4023h: Math Output Scaling 2 PV..... 143
- 2.4.97. Object 4030h: Math Output Process Value..... 144
- 2.4.98. Object 4032h: Math Output Decimal Digits PV ..... 145
- 2.4.99. Object 4y00h: Math Y Input Source ..... 145
- 2.4.100. Object 4y01h: Math Y Input Number ..... 146
- 2.4.101. Object 4y03h: Math Y Input Decimal Digits FV ..... 146
- 2.4.102. Object 4y20h: Math Y Input Scaling 1 FV ..... 147
- 2.4.104. Object 4y40h: Math Y Input Gain ..... 148
- 2.4.105. Object 4y50h: Math Y Operator ..... 149
- 2.4.106. Object 4B00h: Conditional Logic Block Enable ..... 149
- 2.4.107. Object 4B01h: Conditional Logic Result Operator..... 150
- 2.4.108. Object 4B10h: Conditional Logic Output Process Value..... 150
- 2.4.109. Object 4Bxyh: Conditional Logic Block [x] Condition [y] Parameters ..... 151
- 2.4.110. Object 5010h: Constant Field Value ..... 152
- 2.4.111. Object 5040h: Fault Detection Field Value..... 155
- 2.4.112. Object 5041h: FD Set Threshold..... 156
- 2.4.113. Object 5042h: FD Clear Threshold ..... 157
- 2.4.114. Object 5050h: FD Enable Error Check 8 Faults ..... 158
- 2.4.115. Object 5051h: FD Error Response Delay ..... 158
- 2.4.116. Object 5550h: Enable Automatic Updates ..... 159
- 2.4.117. Object 5555h: Start in Operational Mode ..... 159
- 3. TECHNICAL SPECIFICATIONS ..... 160**
  - 3.1. INPUTS..... 160**
  - 3.2. OUTPUTS ..... 161**
  - 3.3. POWER SUPPLY ..... 161**
  - 3.4. GENERAL SPECIFICATIONS ..... 162**
- 4. VERSION HISTORY ..... 163**

# 1. OVERVIEW OF CONTROLLER

## 1.1. Description of I/O Controller

This User Manual describes the architecture and functionality of the 12UIN-12OUT I/O controller with CANopen®.

The Controller is designed for extremely versatile control of 12 universal inputs, as well as 12 proportional valve outputs. Its flexible circuit design gives the user a wide range of configurable input and output types. The sophisticated control algorithms allow the user to program the controller for a wide range of applications without the need for custom software.

On the input side of the controller, the 12 universal inputs can be configured to measure: voltage (0-5V, 0-10V), current (0-20mA, 4-20mA), resistive (40Ohms – 240kOhm), frequency (up to 10kHz), PWM (up to 10kHz), and digital (ON/OFF).

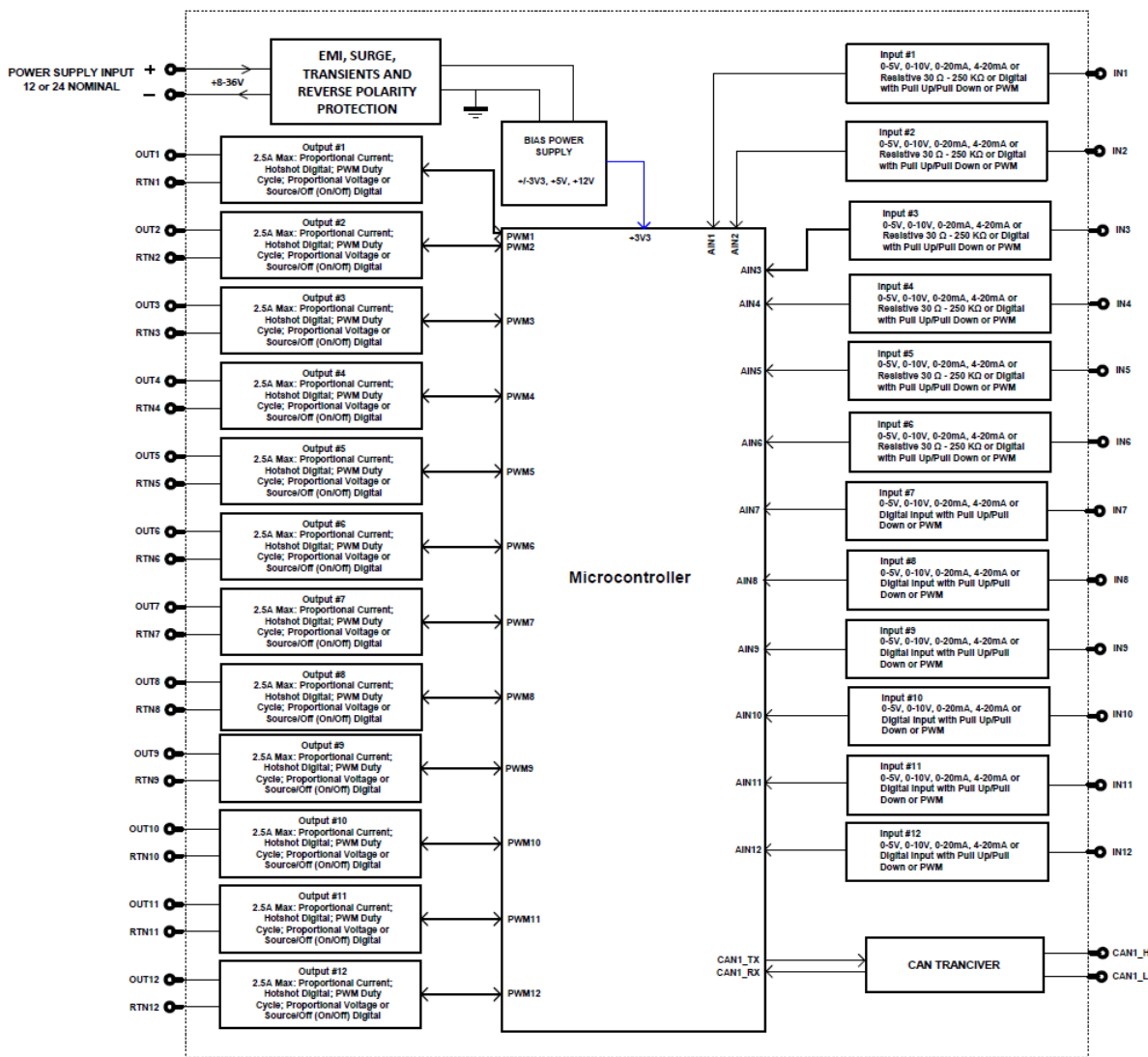

Figure 1 – Hardware Block Diagram



On the output side, the 12 proportional valve outputs can be configured to drive: proportional current (up to 2.5A\*); hotshot digital current; proportional voltage (up to supply); proportional PWM; or straight on/off digital loads.

\*The total current consumption must not exceed 20 A @ 24 Vdc. The total current consumption is a combination of quiescent current and current draw from all the outputs.

The controller is highly programmable, allowing the user to configure it for their application. Its sophisticated control algorithms allow for open or closed loop drive of the proportional output. It can be operated as either a self-contained control system, driving the outputs directly from the on-board logical function blocks, and/or it can be integrated into a CANopen® network of controllers. All outputs and logical function blocks on the unit are inherently independent from one another but can be programmed to interact in a large number of ways. Figure 1 shows the hardware features.

The controller has a number of built-in protection features that can shutoff the outputs in adverse conditions. These features are described in detail in subsequent sections, and they include hardware shutoffs to protect the circuits from being damaged as well as software shutdown features that can be enabled in safety critical systems when an input or CAN fault is detected.

The various function blocks supported by the ECU are outlined in the following sections. All objects are user-configurable using standard commercially available tools that can interact with a CANopen® Object Dictionary via an .EDS file.

## 1.2. Digital Input Function Block

The digital input (DI) function block only becomes applicable on the input when object 6112h, **AI Operation**, is set to a digital input response.

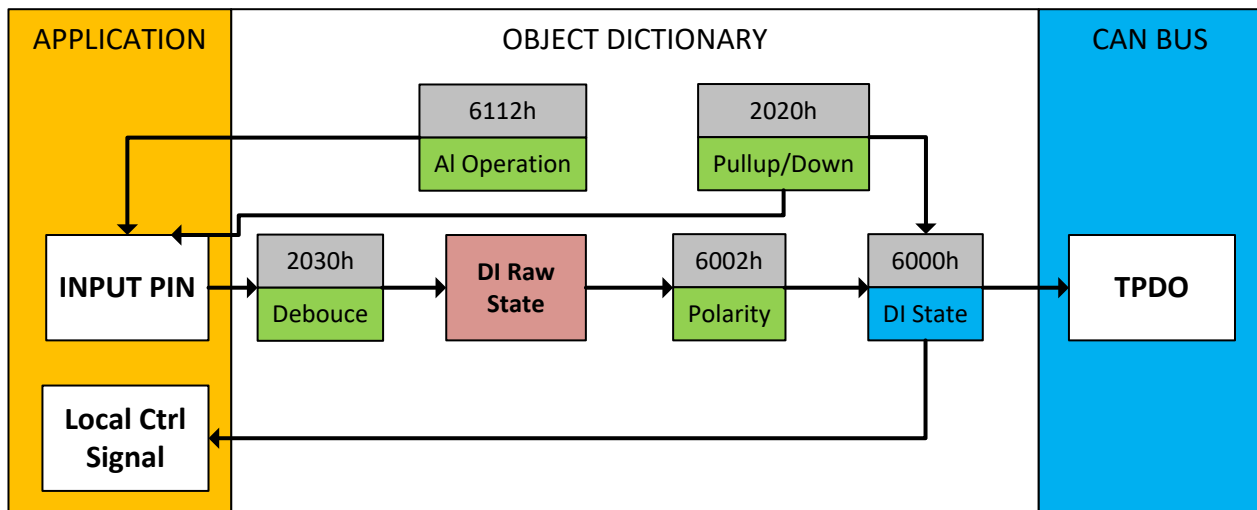

Figure 2 – Digital Input Objects

When object 6112h is set to *10 = Digital Input*, object 2020h **DI Pull-up/Pull-down Mode** will determine the configuration of the internal Pull-up/Pull-down resistors. The options for object 2020h are shown in Table 1, with the default bolded.

Value	Meaning
0	Pullup/Down Disabled (high impedance input)
1	22k $\Omega$ Pullup Resistor Enabled (to 5V)
2	<b>22k<math>\Omega</math> Pulldown Resistor Enabled (to GND)</b>

**Table 1 – DI Pullup/Down Options**

Figure 3 shows the hysteresis on the input when switching a discrete signal. A digital input can be switched up to +Vcc (42Vmax.)

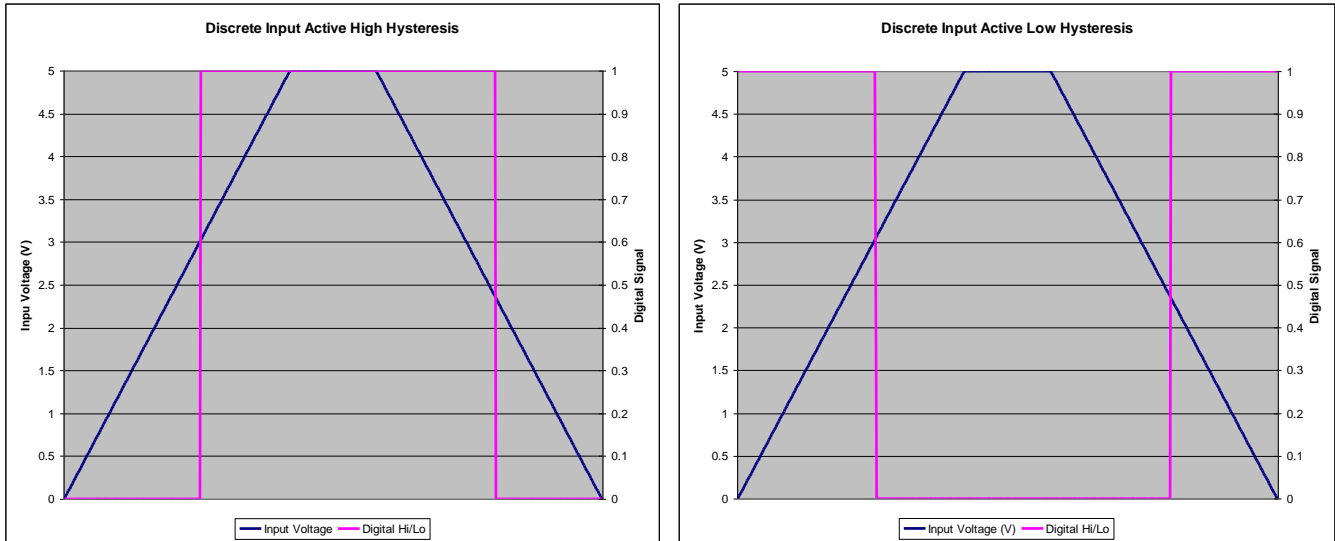
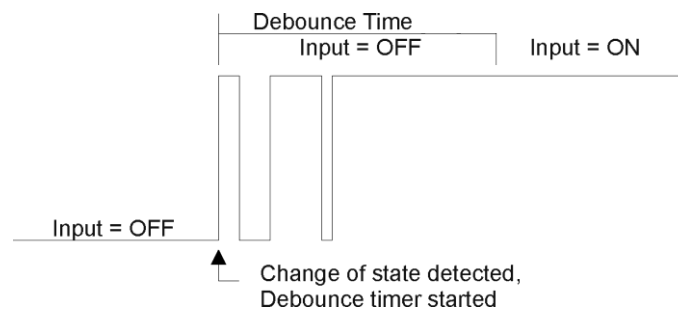

**Figure 3 – Discrete Input Hysteresis**

Object 2030h **DI Debounce Filter** is applied to the input before the state is read by the processor. The options for object 2030h are shown in Table 2, with the default bolded.

Value	Meaning
0	Filter Disabled
1	Filter 142ns
2	<b>Filter 1.14 us</b>
3	Filter 6.10 us

**Table 2 – DI Debounce Filter Options**



**Figure 4 – Digital Input Debouncing**

Once the raw state has been evaluated, the logical state of the input is determined by **object 6002h DI\_Polarity\_8\_Input\_Lines**. The options for object 6002h are shown in Table 3. The state of the DI will be written to read-only object 6000h **DI\_Read\_state\_8\_Input\_Lines**. By default, normal on/off logic is used.

Value	Meaning
0	Normal On/Off
1	Inverse On/Off

**Table 3 – Object 6002h DI\_Polarity\_8\_Input\_Lines options**

The format to write to object 6002h is as follows:

Sub-index 1 will determine the following inputs' polarities:

Bit 7	Bit 6	Bit 5	Bit 4	Bit 3	Bit 2	Bit 1	Bit 0
UI8	UI7	UI6	UI5	UI4	UI3	UI2	UI1

Sub-index 2 will determine the following inputs' polarities:

Bit 7	Bit 6	Bit 5	Bit 4	Bit 3	Bit 2	Bit 1	Bit 0
				UI12	UI11	UI10	UI9

The rest of the bits in sub-index 2 will be ignored. As per the format of object 6002h, the bits in object 6000h **DI\_Read\_state\_8\_Input\_Lines** will be written to represent the same inputs' states.

There is another type of 'digital' input that can be selected when 6112h is set to 20 = Analog On/Off. However, in this case, the input is still configured as an analog input, and therefore the objects from the Analog Input (AI) block are applied instead of those discussed above. Here, objects 2020h, and 2030h are ignored, and 6000h is written as per the logic shown in Figure 5. In this case, the MIN parameter is set by object 7120h **AI Scaling 1 FV**, and the MAX is set by 7122h **AI Scaling 2 FV**.

For all other operating modes, object 6000h will always be zero.

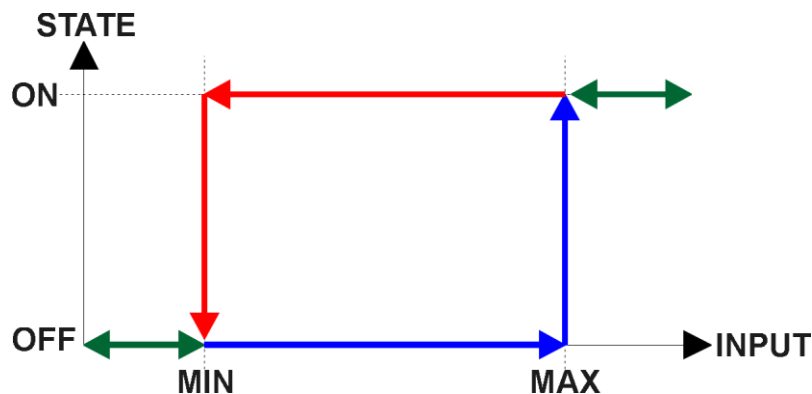

**Figure 5 – Analog Input Read as Digital**

### 1.3. Input Function Block

The analog input (AI) function block is the default logic associated with the universal, analog to digital, and magnetic pickup inputs.

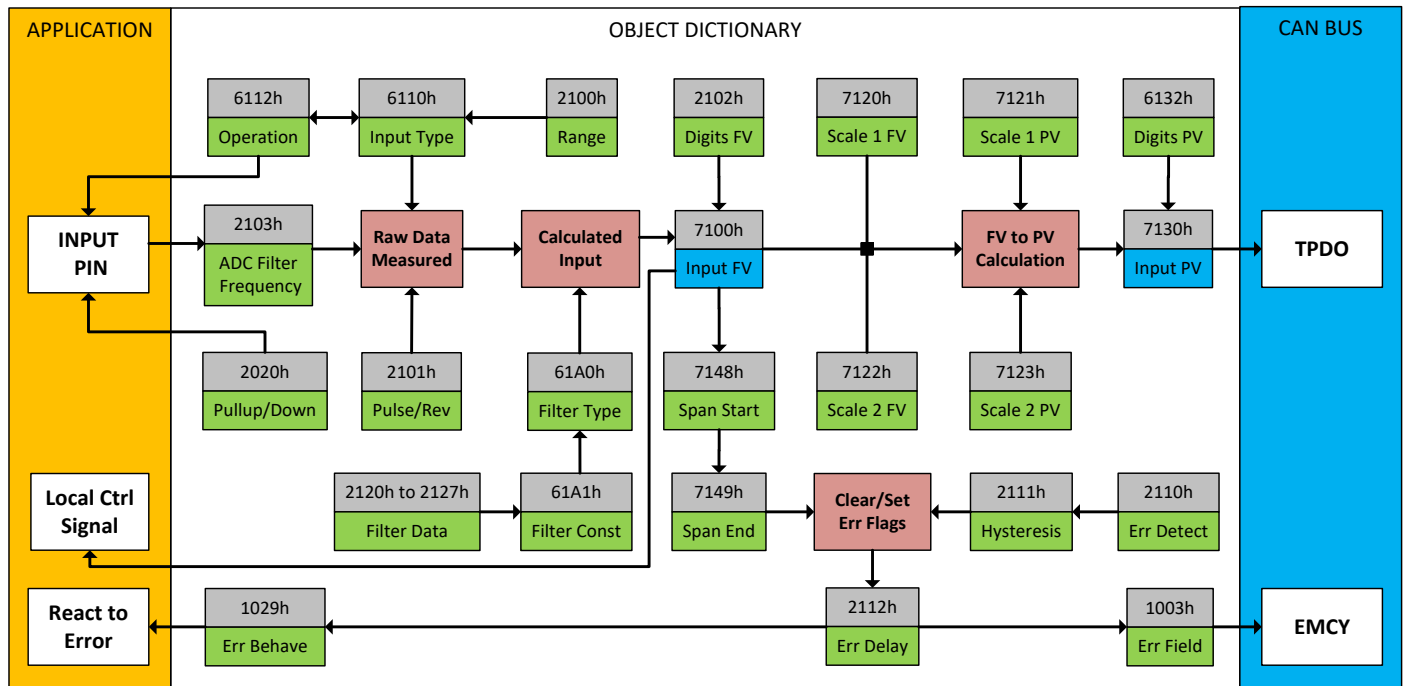

**Figure 6 – Analog Input Objects**

Object 6112h, **AI Operating Mode** determines whether the UI, AI, MI or DI function block is associated with an input. The options for object 6112h are shown in Table 4. No values other than what are shown here will be accepted.

Value	Meaning
0	Channel Off
1	<b>Normal Operation (analog)</b>
10	Digital Input (On/Off)
20	Analog and On/Off

**Table 4 – Object 6112h - AI Operating Mode Options**

Note that the objects relating to the Input Functional Block have sub-indices corresponding to the different inputs on this ECU as follows:

Sub-Index	Corresponding Input
1	Universal Input 1
2	Universal Input 2
3	Universal Input 3
4	Universal Input 4
5	Universal Input 5
6	Universal Input 6
7	Universal Input 7
8	Universal Input 8
9	Universal Input 9
10	Universal Input 10
11	Universal Input 11
12	Universal Input 12

The most important object associate with the AI function block is object 6110h **AI Sensor Type**. By changing this value, and associated with its object 2100h **AI Input Range**, other objects will be automatically updated by the controller. The options for object 6110h are shown in Table 5, and no values other than what are shown here will be accepted. The inputs are setup to measure voltage by default.

**Note:** For object 6110h, the Digital/Magnetic Inputs cannot be changed, and the Analog Inputs can only measure voltage or current.

Value	Meaning
<b>40</b>	<b>Voltage Input</b>
50	Current Input
60	Frequency Input (or RPM)
100	Resistive Input*
10000	PWM Input

**Table 5 – Object 6110h - AI Sensor Type Options**

*\*Note: Only Universal Inputs 1-6 support Resistive Input.*

The allowable ranges will depend on the input selected and input sensor type selected. Table 6 shows the relationship between the sensor type, and the associated range options. The default value for each range is bolded, and object 2100h **AI Range** will automatically be updated with this value when 6110h is changed. The grayed-out cells mean that the associated value is not allowed for the range object when that sensor type has been selected.

Value	Voltage	Current	Frequency	Resistive	PWM
0	<b>0 to 5V</b>	0 to 20mA	0.8Hz to 100Hz	<b>40Ω to 240kΩ</b>	<b>0.8Hz to 10kHz</b>
1	0 to 10V	<b>4 to 20mA</b>	10Hz to 1kHz		
2			<b>100Hz to 10kHz</b>		

**Table 6 – Object 2100h - AI Input Range Options Depending on Sensor Type**

Not all objects apply to all input types. For example, object 2103h **AI Filter Frequency for ADC** is only applicable with a voltage, current or resistive input is being measured. In these cases, the ADC will automatically filter as per Table 7 and is set for 50Hz noise rejection by default.

Value	Meaning
0	Input Filter Off
1	<b>Filter 50Hz</b>
2	Filter 60Hz
3	Filter 50Hz and 60Hz

**Table 7 – Object 2103h - ADC Filter Frequency Options**

Conversely, voltage, frequency and PWM inputs use object 2020h **DI Pull-up/Pull-down Mode** (see Table 1) while, current and resistive inputs set this object to zero. Also, a frequency input can be automatically turned into an RPM measurement instead simply by setting object 2101h **AI Number of Pulses Per Revolution** to a non-zero value. All other input types ignore this object. Note that the AI Input FV/PV are limited to a size of 16 bits, meaning the RPM cannot exceed 6553.5 (1 Decimal digit by default, see **Table 9**) or the value will overflow.

Regardless of type, however, all analog inputs can be further filtered once the raw data has been measured (either from ADC or Timer.) Object 61A0h **AI Filter Type** determines what kind of filter is used per Table 8. By default, additional software filtering is disabled.

Value	Meaning
0	<b>No Filter</b>
1	Moving Average
2	Repeating Average
3	Third-Order Low Pass

**Table 8 – Object 61A0h - AI Filter Type Options**

Object 61A1h **AI Filter Constant** is used with all three types of filters as per the formulas below:

Calculation with no filter:

Value = Input

The data is simply a ‘snapshot’ of the latest value measured by the ADC or timer.

Calculation with the moving average filter:

$$\text{Value}_N = \text{Value}_{N-1} + \frac{(\text{Input} - \text{Value}_{N-1})}{\text{FilterConstant}}$$

This filter is called every 1ms. The value FilterConstant stored in object 61A1h is 10 by default.

Calculation with the repeating average filter:

$$\text{Value} = \frac{\sum \text{Input}_N}{N}$$

At every reading of the input value, it is added to the sum. At every N<sup>th</sup> read, the sum is divided by N, and the result is the new input value. The value and counter will be set to zero for the next read. The value of N is stored in object 61A1h and is 10 by default. This filter is called every 1ms.

Calculation with the 3<sup>rd</sup> Order Low Pass filter:

$$\text{Value}_N = \frac{C_{IN0} * \text{Input}_N + C_{IN1} * \text{Input}_{N-1} + C_{IN2} * \text{Input}_{N-2} + C_{IN3} * \text{Input}_{N-3} + C_{OUT1} * \text{Value}_{N-1} + C_{OUT2} * \text{Value}_{N-2} + C_{OUT3} * \text{Value}_{N-3}}{2^{\text{Power}}}$$

C <sub>IN0</sub>	Coefficient for Input(n)	C <sub>OUT1</sub>	Coefficient for Output(n-1)
C <sub>IN1</sub>	Coefficient for Input(n-1)	C <sub>OUT2</sub>	Coefficient for Output(n-2)
C <sub>IN2</sub>	Coefficient for Input(n-2)	C <sub>OUT3</sub>	Coefficient for Output(n-3)
C <sub>IN3</sub>	Coefficient for Input(n-3)		

This filter uses 16-bit fixed point math. Object 2120h **AI Third-Order Filter Power** tells the controller the shift value used when the coefficients were selected.

The value of object 61A1h determines how often the filter is called (in ms) and is set to 10 by default. In between calls, the data of the input signal is the value which was calculated the last time the filter was called. The filter coefficients are stored in objects 2121h to 2127h.

The value from the filter is shifted according to read-only object 2102h **AI Decimal Digits FV** and then written to read-only object 7100h **AI Input Field Value**.

The value of 2102h will depend on the AI Sensor Type and Input Range selected and will be automatically updated per Table 9 when either 6110h or 2100h are changed. All other objects associated with the input field value also apply this object. These objects are 7120h **AI Scaling 1 FV**, 7122h **AI Scaling 2 FV**, 7148h **AI Span Start**, 7149h **AI Span End**, and 2111h **AI Error Clear Hysteresis**. These objects are also automatically updated when the Type or Range is changed.

Sensor Type and Range	Decimal Digits
Voltage: All Ranges	3 [mV]
Current: All Ranges	3 [uA]
Resistive: Full Range	2 [0.01 kΩ]
Frequency: 0.8Hz to 100Hz	2 [0.01 Hz]
Frequency: 10Hz to 1kHz	1 [0.1 Hz]
Frequency: 100Hz to 10kHz	0 [Hz]
Frequency: RPM Mode	1 [0.1 RPM]
PWM: All Ranges	1 [0.1 %]
Digital Input	0 [On/Off]

**Table 9 – Object 2102h - AI Decimal Digits FV Depending on Sensor Type**

It is the **AI Input FV** which is used by the application for error detection, and as a control signal for other logic blocks (i.e. output control.) Object 7100h is mappable to a TPDO and is mapped to TPDO1 by default.

Read-only object 7130h **AI Input Process Value** is also mappable . However, the default values for objects 7121h **AI Scaling 1 PV** and 7123h **AI Scaling 2 PV** are set to equal 7120h and 7122h respectively, while object 6132h **AI Decimal Digits PV** is automatically initialize to equal 2102h. This means that the default relationship between the FV and PV is one-to-one, so object 7130h is not mapped to a TPDO by default.

Should a different linear relationship between what is measured versus what is sent to the CANopen® bus be desired, objects 6132h, 7121h and 7123h can be changed. The linear relationship profile is shown in Figure 7 below. Should a non-linear response be desired, the lookup table function block can be used instead, as described in section 1.7.

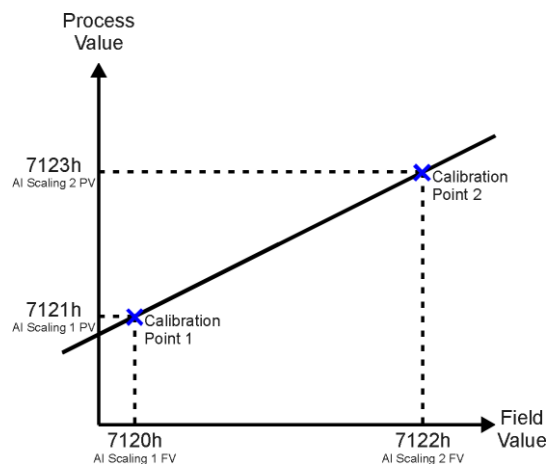

**Figure 7 – Analog Input Linear Scaling FV to PV**

As stated earlier, the FV scaling objects are automatically updated with the Sensor Type or Range changes. This is because objects 7120h and 7122h are not only used in a linear conversion from FV to PV as described above, but also as the minimum and maximum limits when the input is used to control another logic block. Therefore, the values in these objects are important, even when the AI Input PV object is not being used.

The AI Span Start and AI Span End objects are used for fault detection, so they too are automatically updated for sensible values as the Type/Range changes. The Error Clear Hysteresis object is also updated, as it too is measured in the same unit as the AI Input FV object.

Table 10 lists the default values that are loaded into objects 7120h, 7122h, 7148h, 7149h, and 2111h for each Sensor Type and Input Range combination. Recall that these objects all have the decimal digits applied to them as outlined in Table 9.

Sensor Type/ Input Range	7148h AI Span Start (i.e. Error Min)	7120h AI Scaling 1 FV (i.e. Input Min)	7122h AI Scaling 2 FV (i.e. Input Max)	7149h AI Span End (i.e. Error Max)	2111h Error Clear Hysteresis
Voltage: 0 to 1V	50 [mV]	100 [mV]	1000 [mV]	1050 [mV]	25 [mV]
Voltage: 0 to 2.5V	100 [mV]	250 [mV]	2500 [mV]	2600 [mV]	50 [mV]
Voltage: 0 to 5V	200 [mV]	500 [mV]	4500 [mV]	4800 [mV]	100 [mV]
Voltage: 0 to 10V	200 [mV]	500 [mV]	9500 [mV]	9800 [mV]	200 [mV]
Current: 0 to 20mA	0 [uA]	40 [uA]	20000 [uA]	21000 [uA]	250 [uA]
Current: 4 to 20mA	1000 [uA]	4000 [uA]	20000 [uA]	21000 [uA]	250 [uA]
Resistive: 0.04 to 240kΩ	2 [0.01kΩ]	10 [0.01kΩ]	20000 [0.01kΩ]	25000 [0.01kΩ]	1 [0.01kΩ]
Freq: 0.5Hz to 50Hz	100 [0.01Hz]	500 [0.01Hz]	5000 [0.01Hz]	5500 [0.01Hz]	20 [0.01Hz]
Freq: 10Hz to 1kHz	50 [0.1Hz]	100 [0.1Hz]	10000 [0.1Hz]	11000 [0.1Hz]	50 [0.1Hz]
Freq: 100Hz to 10kHz	50 [Hz]	100 [Hz]	10000 [Hz]	10500 [Hz]	10 [Hz]
Freq: RPM Mode	500 [0.1RPM]	1000 [0.1RPM]	30000 [0.1RPM]	33000 [0.1RPM]	100 [0.1RPM]
PWM: 0 to 100%	10 [0.1%]	50 [0.1%]	950 [0.1%]	990 [0.1%]	10 [0.1%]
Digital Input	OFF	OFF	ON	ON	0

**Table 10 – AI Object Defaults Based on Sensor Type and Input Range**



It might not be desired in a particular application for the automatic updating of objects when a key object is changed, i.e. AI Sensor Type. In this case, object 5550h **Enable Automatic Updates** can be set to FALSE (true by default) in which case changing an object will have no impact on any other objects. In this mode, the user must manually change all the objects for sensible values, or the controller will not work as expected.

When changing these objects, Table 11 outlines the range constraints places on each based on the Sensor Type and Input Range combination selected. In all cases, the MAX value is the upper end of the range (i.e. 5V or ) Object 7122h cannot be set higher than MAX, whereas 7149h can be set up to 110% of MAX. Object 2111h on the other hand can only be set up to maximum value of 10% of MAX. Table 11 uses the base unit of the input, but recall the limits will also have object 2102h apply to them as per Table 9.

Sensor Type/ Input Range	7148h	7120h	7122h	7149h	2111h
Voltage: 0 to 1V, 0 to 2.5V, 0 to 5V and 0 to 10V Current: 0 to 20mA RPM: 0 to 6000RPM PWM: 0 to 100%	0 to 7120h	7148h to 7122h	7120h to 7149h If(7149h>MAX) 7120h to MAX	7122h to 110% of MAX	10% of MAX
Current: 4 to 20mA	0 to 7120h	7148h to 7122h If(7148h<4mA) 4mA to 7122h			
Resistive: 0.04 to 240kΩ	25Ω to 7120h	7148h to 7122h			
Freq: 0.5Hz to 50Hz	0.1Hz to 7120h	7148h to 7122h If(7148h<0.5Hz) 0.5Hz to 7122h			
Freq: 10Hz to 1kHz	5Hz to 7120h	7148h to 7122h If(7148h<10Hz) 10Hz to 7122h			
Freq: 100Hz to 10kHz	50Hz to 7120h	7148h to 7122h If(7148h<100Hz) 100Hz to 7122h			

**Table 11 – AI Object Ranges Based on Sensor Type and Input Range**

The last objects associated with the analog input block left to discuss are those associated with fault detection. Should the calculated input (after measuring and filtering) fall outside of the allowable range, as defined by the AI Span Start and AI Span End objects, an error flag will be set in the application if and only if object 2110h **AI Error Detect Enabled** is set to TRUE (1).

When (7100h AI Input FV < 7148h AI Span Start), an “Out of Range Low” flag is set. If the flag stays active for the 2112h **AI Error Reaction Delay** time, an Input Overload Emergency (EMCY) message will be added to object 1003h **Pre-Defined Error Field**. Similarly, when (7100h AI Input FV > 7149h AI Span End), an “Out of Range High” flag is set, and will create an EMCY message should it stay active throughout the delay period. In either case, the application will react to the EMCY message as defined by object 1029h **Error Behaviour** at the sub-index corresponding to an Input Fault. Refer to section 3.2.4 and 3.2.13 for more information about objects 1003h and 1029h.

Once the fault has been detected, the associate flag will be cleared only once the input comes back into range. Object 2111h **AI Error Clear Hysteresis** is used here so that the error flag will not be set/cleared continuously while the AI Input FV hovers around the AI Span Start/End value.

To clear an “Out of Range Low” flag, AI Input FV >= (AI Span Start + AI Error Clear Hysteresis)  
 To clear an “Out of Range High” flag, AI Input FV <= (AI Span End - AI Error Clear Hysteresis)  
 Both flags cannot be active at once. Setting either one of these flags automatically clears the other.

## 1.4. Digital Output Function Block

The digital output (DO) function block only becomes applicable on the output when object 6310h, **AO Output Type**, is set to a digital output type (Output type = 1000 or 1020).

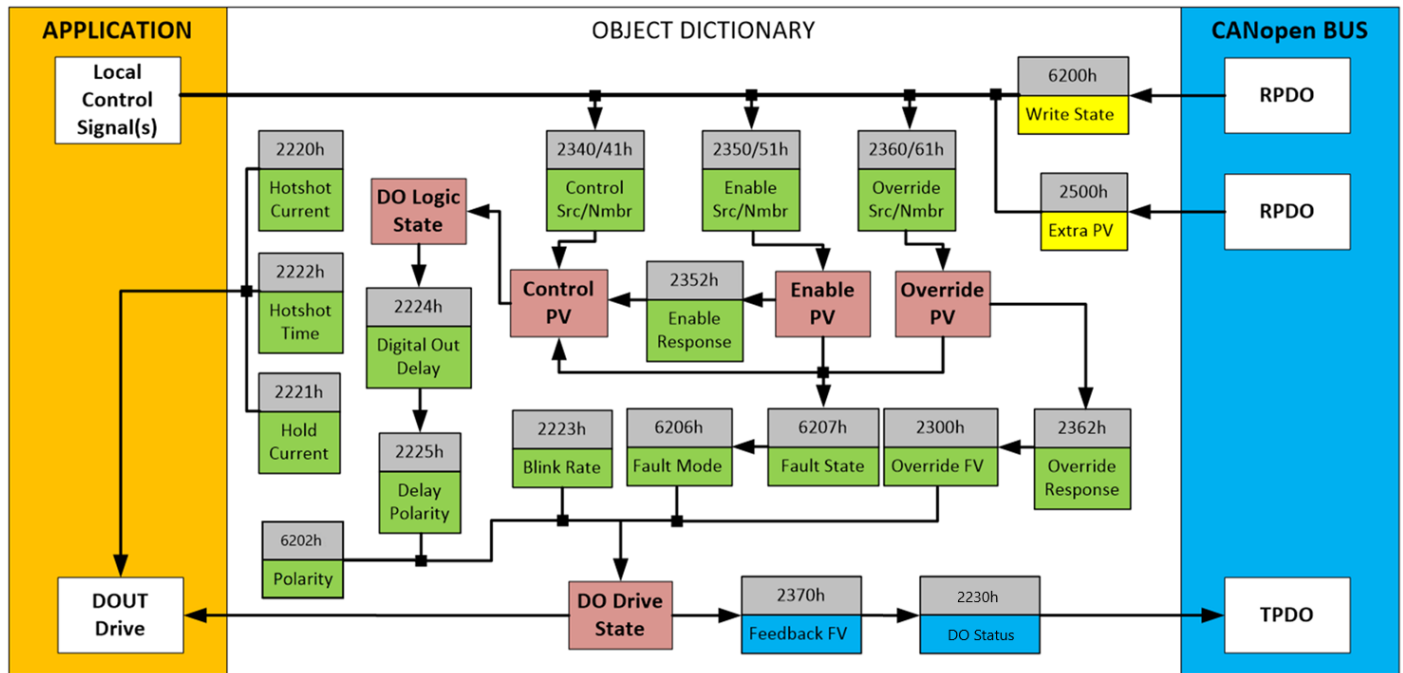

Figure 8 – Digital Output Objects

Several of the objects shown in the above diagram are in fact associated with the Analog Output function block and are explained in detail in Section 1.5. Therefore, this section will only elaborate on the objects unique to the DO function block.

An output can be controlled either by an on-board control signal (such the result from a lookup table or a math function) or a CANopen® object that has been mapped to an RPDO. In the case of an output configured for a digital response, when a CANopen® Message has been selected as the 2340h **AO Control Input Source** (see Table 15), then data from the appropriate bit within the sub-index from write-mappable object 6200h **DO Write state 8 output lines** will be used as the control signal. The format of object 6200h will be as follows:

6200h Subindex 1:

D7	D6	D5	D4	D3	D2	D1	D0
PO8	PO7	PO6	PO5	PO4	PO3	PO2	PO1

6200h Subindex 2

D7	D6	D5	D4	D3	D2	D1	D0
-	-	-	-	PO12	PO11	PO10	PO9

For digital outputs, the Enable and Override Inputs and Responses in the digital mode are the same as for an Analog Output and are evaluated in the same order. Therefore, what is described in Section 1.5 for these also applied for the DO function block for all outputs.

As with the AO function, the DO will respond to the Control Input if and only if the following conditions have been met:

- a) No fault is detected for any of the control signals
- b) The override command is either ignored or false (Override Input)
- c) The output has not been disabled by a secondary signal (Enable Input)

The resulting **DO\_Write\_state\_8\_output\_lines** will depend on the object 6202h **DO\_Polarity\_8\_output\_lines**, as per Table 12. By default, normal on/off output logic is used.

Value	Meaning	DO Logic State	DO Drive State
0	Normal On/Off	OFF	OFF
		ON	ON
1	Inverse On/Off	OFF	ON
		ON	OFF

**Table 12 – Object 6202h - DO Polarity Options**

When the regular on/off output logic is used, objects 2224h **Digital Out Delay** and 2225h **Delay Polarity** come to effect. When this object is >0ms, however, this value will determine how long after the output reacts once it is commanded has been driven will the output react. Object 2225h **Delay Polarity** determines on which edge the delay will affect. By default, **Digital Out Delay** is set to 0ms (no delay), and **Delay Polarity** is set to rising edge – in which case the output will react as soon as it is commanded.

The read-only mappable object 2370h **AO Feedback FV** will be loaded with the **DO Drive State** (0=OFF, 1=ON) when the output is setup for a digital type.

An additional read-only mappable object 2230h **DO Output Status** is provided, which provides feedback on the state of an output configured for Digital ON/OFF mode. The values for this object are as follows:

- 0 – Inactive:** The output is OFF, or is not configured for Digital On/Off mode.
- 1 – Active:** The output is ON, and no faults are detected.
- 2 – Open Circuit:** The output is commanded ON, but no current feedback is measured.
- 3 – Short Circuit:** Output short circuit fault detected. This is measured using internal hardware SC pin.

In addition to a straight ON/OFF digital output (where ON = +Vps applied to output pin), there is a second type of digital output called a “Hotshot.” This output is designed to work with inductive loads (i.e. a hydraulic valve) that can be hotshot with a high current for a short period of time to fully open the load. Then, the current is dropped back to a lower holding value to keep it open until the **DO Drive State** turns off as shown in Figure 9.

Objects 2220h **DO Hotshot Current**, 2221h **DO Hold Current**, and 2222h **DO Hotshot Time** are used with this output type to drive the load. Since the output timer is used for the hotshot time, DO Polarity option 3, Blinking Logic does not apply with this output type. The response in this case will be the same as option 1, Normal On/Off logic.

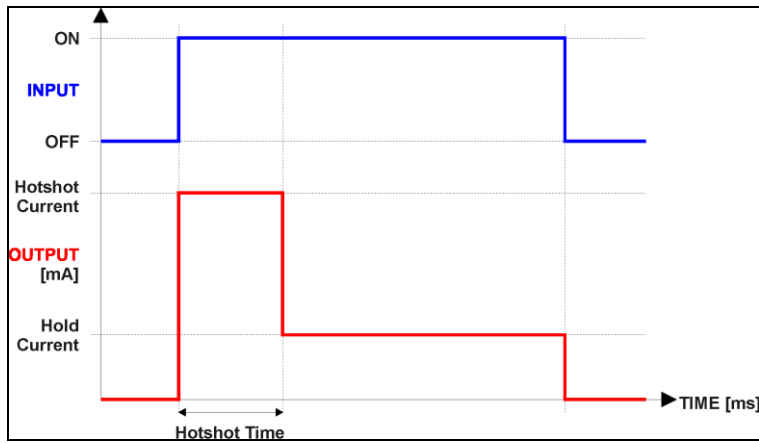

**Figure 9 – Hotshot Digital Profile**

As mentioned in the Controller Overview, any digital output can be setup to react to a fault detected on any of the *inputs* to the function block (control, enable or override.) Should any one of these inputs be showing an error condition, object 6206h **DO Fault Mode** determines how the output will respond, per Table 13. By default, the output will revert to the state defined in object 6207h **DO Fault State**.

Value	Meaning
0	Maintain Last State
1	<b>Apply Pre-Defined State</b>

**Table 13 – Object 6206h - DO Fault Mode Options**

## 1.5. Analog Output Function Block

The analog output (AO) function block is the default logic associate with outputs 1 through 12.

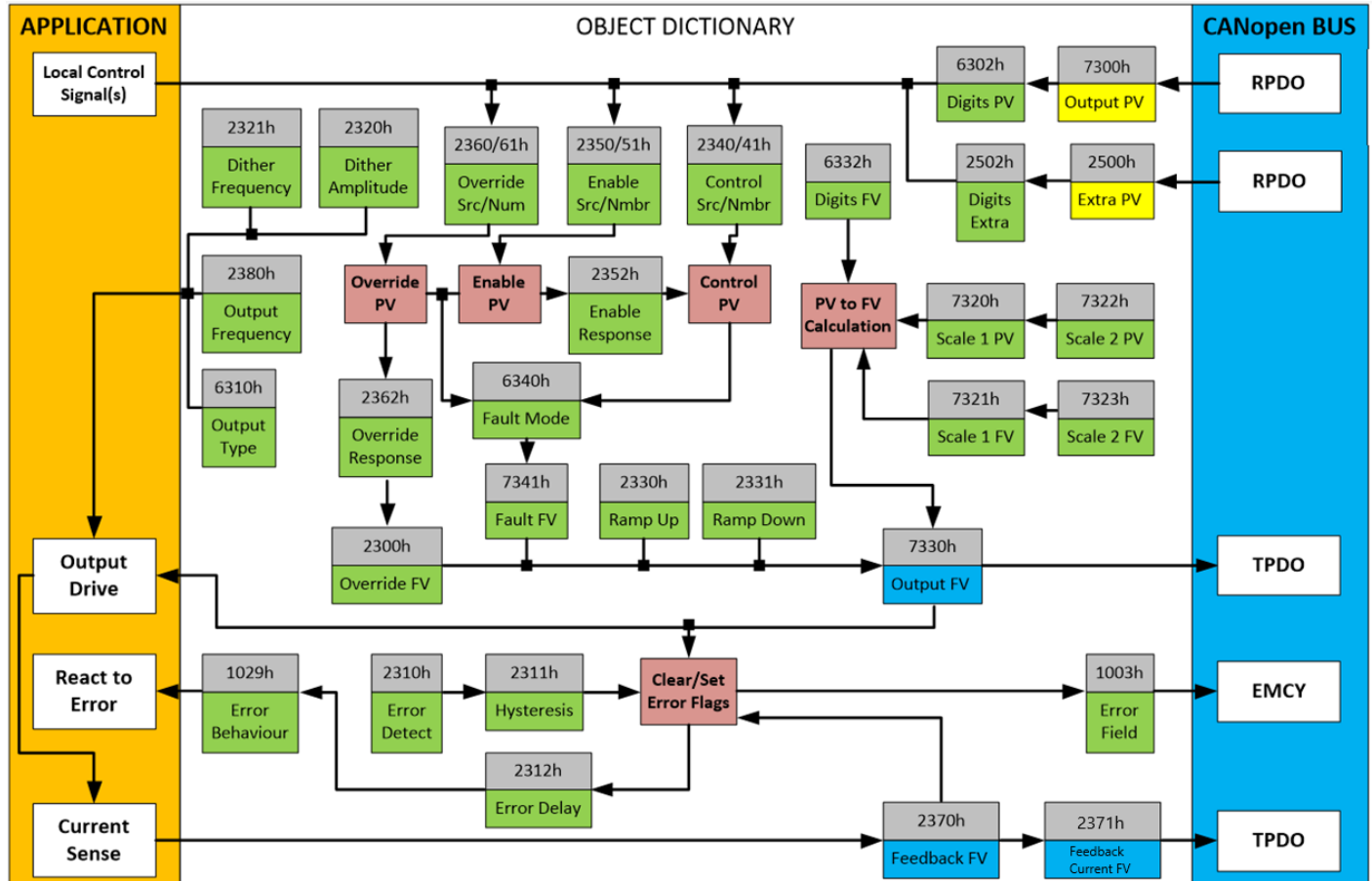

Figure 10 – Analog Output Objects

There are many objects associated with the analog output function block, but not all of them apply to all output types or control conditions. To start with, object 6310h **AO Output Type** defines how the output drive circuitry will be configured as per Table 14. This table also shows the output unit and range for each type. By default, analog outputs are configured as output voltage types, and the Proportional Output is configured as proportional current type.

Value	Meaning	Proportional Output Range [Unit]	Analog Output Range
0	Output Disabled	N/A	N/A
10	Output Voltage	0 to 48 [V]	0 to 10[V]
<b>20</b>	<b>Output Current</b>	<b>0 to 2000 [mA]</b>	N/A
40	Output PWM	0 to 100 [%]	0 to 100 [%]
1000	Output Digital On/Off	0 (OFF) or 1 (ON)**	0 (OFF) or 1 (ON)
1020	Output Digital Hotshot	0 (OFF) or 1 (ON)	0 (OFF) or 1 (ON)

Table 14 – Object 6310h - AO Output Type Options

Note that the objects relating to the Output Functional Block have sub-indices corresponding to the different outputs on this ECU as follows:

Sub-Index	Corresponding Input
1	Proportional Output 1
2	Proportional Output 2
3	Proportional Output 3
4	Proportional Output 4
5	Proportional Output 5
6	Proportional Output 6
7	Proportional Output 7
8	Proportional Output 8
9	Proportional Output 9
10	Proportional Output 10
11	Proportional Output 11
12	Proportional Output 12

When the output type is changed, all objects related to the output (scaling PV, Decimal Digits PV, etc.) are automatically updated by default. Object 5550h enables/disables automatic updates. When disabled (set to False), the objects are to be manually configured.

In regard to Proportional Valve output, the Current output controlled by a close-loop PID control, and these objects should not be changed without proper consideration. In Voltage mode, the output is actually a high frequency PWM signal that is being adjusted by the processor such that the average voltage would match the target FV, up to the supply voltage. *External filtering of the signal would have to be applied to get a true DC voltage.* In PWM mode, the FV represents the output duty cycle. The digital output types have been covered in Section 1.2

The relationship between the Process Value (input) and the Field Value (output) is a linear one, as shown in Figure 11. However, the output will actually use the AO Scaling FV objects as limits to the drive, such that the output will hold at the minimum and maximum FV points, as shown in the figure.

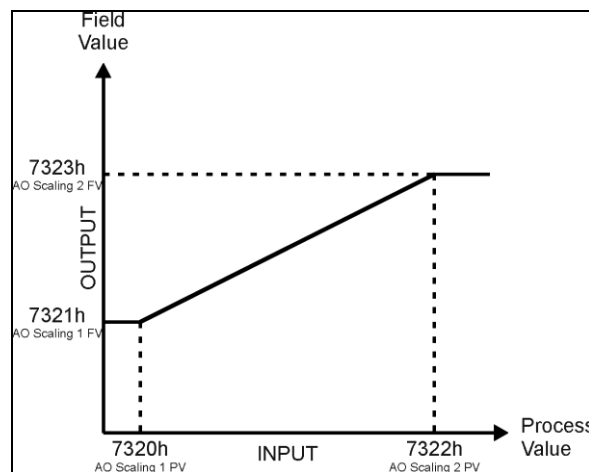

Figure 11 – Analog Output Linear Scaling PV to FV

## 1.6. Available Control Sources

The 12UIN-12OUT controller allows for the PV input to be selected from the list of the logical function blocks supported by the controller as shown in Figure 1B. As a result, any output from one function block can be selected as the control source for another. Keep in mind that not all options make sense in all cases, but the complete list of control sources is shown in Table 15. By default, analog outputs are setup to respond to the corresponding CANopen® RPDO message.

**Note:** The output blocks can only be driven by their respective CANopen® RPDO message, shown by the defaults as specified in Table 16.

Value	Meaning
0	Control Source Not Used (Ignored)
1	CANopen® Message (RPDO)
2	Input Function Block
3	Constant Function Block
4	PID Control Function Block
5	Lookup Table Function Block
6	Set-Reset Latch Function Block
7	Conditional Logic Function Block
8	Mathematical Function Block
9	Programmable Logic Function Block
10	Output Commanded Field Value
11	Output Feedback Field Value
12	Power Supply Measured*
13	Processor Temperature Measured*

*\*Control Source cannot be used to drive Proportional Outputs*

**Table 15 – Control Source Options**

In addition to a source, each control also has a number which corresponds to the sub-index of the function block in question. Table 16 outlines the ranges supported for the number objects, depending on the source that had been selected.

Control Source	Range	Object (Meaning)
Control Source Not Used	0	Ignored
<b>CANopen® Message (RPDO)</b>	1	7300h sub-index 1 (Analog) <b>or</b> 6200h sub-index 1 bit 0 (Digital) (Proportional Output 1 PV)
	2	7300h sub-index 2 (Analog) <b>or</b> 6200h sub-index 1 bit 1 (Digital) (Proportional Output 2 PV)
	3	7300h sub-index 3 (Analog) <b>or</b> 6200h sub-index 1 bit 2 (Digital) (Proportional Output 3 PV)
	4	7300h sub-index 4 (Analog) <b>or</b> 6200h sub-index 1 bit 3 (Digital) (Proportional Output 4 PV)
	5	7300h sub-index 5 (Analog) <b>or</b> 6200h sub-index 1 bit 4 (Digital) (Proportional Output 5 PV)
	6	7300h sub-index 6 (Analog) <b>or</b> 6200h sub-index 1 bit 5 (Digital) (Proportional Output 6 PV)
	7	7300h sub-index 7 (Analog) <b>or</b> 6200h sub-index 1 bit 6 (Digital) (Proportional Output 7 PV)
	8	7300h sub-index 8 (Analog) <b>or</b> 6200h sub-index 1 bit 7 (Digital) (Proportional Output 8 PV)
	9	7300h sub-index 9 (Analog) <b>or</b> 6200h sub-index 2 bit 0 (Digital) (Proportional Output 9 PV)
	10	7300h sub-index 10 (Analog) <b>or</b> 6200h sub-index 2 bit 1 (Digital) (Proportional Output 10 PV)
	11	7300h sub-index 11 (Analog) <b>or</b> 6200h sub-index 2 bit 2 (Digital) (Proportional Output 11 PV)
	12	7300h sub-index 12 (Analog) <b>or</b> 6200h sub-index 2 bit 3 (Digital) (Proportional Output 12 PV)
	13	2500h sub-index 1 (Extra Received PV 1)
	14	2500h sub-index 2 (Extra Received PV 2)
	15	2500h sub-index 3 (Extra Received PV 3)
	16	2500h sub-index 4 (Extra Received PV 4)
	17	2500h sub-index 5 (Extra Received PV 5)
	18	2500h sub-index 6 (Extra Received PV 6)
	19	2500h sub-index 7 (Extra Received PV 7)
	20	2500h sub-index 8 (Extra Received PV 8)
	21	2500h sub-index 9 (Extra Received PV 9)
	22	2500h sub-index 10 (Extra Received PV 10)



<b>Analog Input Function Block</b>	1	7100h sub-index 1 or 6000h sub-index 1 bit 0
	2	7100h sub-index 2 or 6000h sub-index 1 bit 1
	3	7100h sub-index 3 or 6000h sub-index 1 bit 2
	4	7100h sub-index 4 or 6000h sub-index 1 bit 3
	5	7100h sub-index 5 or 6000h sub-index 1 bit 4
	6	7100h sub-index 6 or 6000h sub-index 1 bit 5
	7	7100h sub-index 7 or 6000h sub-index 1 bit 6
	8	7100h sub-index 8 or 6000h sub-index 1 bit 7
	9	7100h sub-index 9 or 6000h sub-index 2 bit 0
	10	7100h sub-index 10 or 6000h sub-index 2 bit 1
	11	7100h sub-index 11 or 6000h sub-index 2 bit 2
	12	7100h sub-index 12 or 6000h sub-index 2 bit 3
<b>Constant Function Block</b>	1	5010h sub-index 1 (always FALSE)
	2	5010h sub-index 2 (always TRUE)
	3	5010h sub-index 3 (Constant FV 3)
	4	5010h sub-index 4 (Constant FV 4)
	5	5010h sub-index 5 (Constant FV 5)
	6	5010h sub-index 6 (Constant FV 6)
	7	5010h sub-index 7 (Constant FV 7)
	8	5010h sub-index 8 (Constant FV 8)
	9	5010h sub-index 9 (Constant FV 9)
	10	5010h sub-index 10 (Constant FV 10)
	11	5010h sub-index 11 (Constant FV 11)
	12	5010h sub-index 12 (Constant FV 12)
	13	5010h sub-index 13 (Constant FV 13)
	14	5010h sub-index 14 (Constant FV 14)
	15	5010h sub-index 15 (Constant FV 15)
<b>PID Control Function Block</b>	1	2460h sub-index 1 (PID Output FV 1)
	2	2460h sub-index 2 (PID Output FV 2)
	3	2460h sub-index 3 (PID Output FV 3)
	4	2460h sub-index 4 (PID Output FV 4)
	5	2460h sub-index 5 (PID Output FV 5)
	6	2460h sub-index 6 (PID Output FV 6)
	7	2460h sub-index 7 (PID Output FV 7)
	8	2460h sub-index 8 (PID Output FV 8)
	9	2460h sub-index 9 (PID Output FV 9)
	10	2460h sub-index 10 (PID Output FV 10)
	11	2460h sub-index 11 (PID Output FV 11)
	12	2460h sub-index 12 (PID Output FV 12)

<b>Lookup Table Function Block</b>	1	3017h (Lookup Table 1 Output Y-Axis PV)
	2	3027h (Lookup Table 2 Output Y-Axis PV)
	3	3037h (Lookup Table 3 Output Y-Axis PV)
	4	3047h (Lookup Table 4 Output Y-Axis PV)
	5	3057h (Lookup Table 5 Output Y-Axis PV)
	6	3067h (Lookup Table 6 Output Y-Axis PV)
	7	3077h (Lookup Table 7 Output Y-Axis PV)
	8	3087h (Lookup Table 8 Output Y-Axis PV)
	9	3097h (Lookup Table 9 Output Y-Axis PV)
<b>Set-Reset Latch Function Block</b>	1	3910h sub-index 1 (SR Latch 1 Output PV)
	2	3910h sub-index 2 (SR Latch 2 Output PV)
	3	3910h sub-index 3 (SR Latch 3 Output PV)
	4	3910h sub-index 4 (SR Latch 4 Output PV)
	5	3910h sub-index 5 (SR Latch 5 Output PV)
<b>Conditional Logic Block</b>	1	4B10h sub-index 1 (Cond Logic 1 Output PV)
	2	4B10h sub-index 2 (Cond Logic 2 Output PV)
	3	4B10h sub-index 3 (Cond Logic 3 Output PV)
	4	4B10h sub-index 4 (Cond Logic 4 Output PV)
	5	4B10h sub-index 5 (Cond Logic 5 Output PV)
	6	4B10h sub-index 6 (Cond Logic 6 Output PV)
	7	4B10h sub-index 7 (Cond Logic 7 Output PV)
	8	4B10h sub-index 8 (Cond Logic 8 Output PV)
	9	4B10h sub-index 9 (Cond Logic 9 Output PV)
	10	4B10h sub-index 10 (Cond Logic 10 Output PV)
<b>Mathematical Function Block</b>	1	4350h sub-index 1 (Math Output PV 1)
	2	4350h sub-index 2 (Math Output PV 2)
	3	4350h sub-index 3 (Math Output PV 3)
	4	4350h sub-index 4 (Math Output PV 4)
	5	4350h sub-index 5 (Math Output PV 5)
	6	4350h sub-index 6 (Math Output PV 6)
<b>Programmable Logic Function Block</b>	1	3xy7h (Lookup Table Selected by Logic 1)
	2	3xy7h (Lookup Table Selected by Logic 2)
	3	3xy7h (Lookup Table Selected by Logic 3)

<b>NOTE: The following options should be considered for diagnostic feedback, and should not be selected as a control source for logic inputs (i.e. output control or lookup table X-Axis)</b>		
<b>Output Commanded Field Value</b>	1	7330h sub-index 1 or 6000h sub-index 1 bit 0
	2	7330h sub-index 2 or 6000h sub-index 1 bit 1
	3	7330h sub-index 3 or 6000h sub-index 1 bit 2
	4	7330h sub-index 4 or 6000h sub-index 1 bit 3
	5	7330h sub-index 5 or 6000h sub-index 1 bit 4
	6	7330h sub-index 6 or 6000h sub-index 1 bit 5
	7	7330h sub-index 7 or 6000h sub-index 1 bit 6
	8	7330h sub-index 8 or 6000h sub-index 1 bit 7
	9	7330h sub-index 9 or 6000h sub-index 2 bit 0
	10	7330h sub-index 10 or 6000h sub-index 2 bit 1
	11	7330h sub-index 11 or 6000h sub-index 2 bit 2
	12	7330h sub-index 12 or 6000h sub-index 2 bit 3
<b>Output Feedback Field Value</b>	1	2370h sub-index 1 (PO1 FB)
	2	2370h sub-index 2 (PO2 FB)
	3	2370h sub-index 3 (PO3 FB)
	4	2370h sub-index 4 (PO4 FB)
	5	2370h sub-index 5 (PO5 FB)
	6	2370h sub-index 6 (PO6 FB)
	7	2370h sub-index 7 (PO7 FB)
	8	2370h sub-index 8 (PO8 FB)
	9	2370h sub-index 9 (PO9 FB)
	10	2370h sub-index 10 (PO10 FB)
	11	2370h sub-index 11 (PO11 FB)
	12	2370h sub-index 12 (PO12 FB)
<b>Processor Temperature Measured</b>	N/A	5040h (Temperature FV) sub-index 1
<b>Power Supply Measured</b>	N/A	5040h (Power Supply FV) sub-index 2

**Table 16 – Control Number Options Depending on Source Selected**

There are three inputs to the output function block, each one with a unique source and number object. For the control function (PV axis in Figure 11), objects 2340h **AO Control Input Source** and 2341h **AO Control Input Number** are used. For the enable function, objects 2350h **AO Enable Input Source** and 2351h **AO Enable Input Number** are used. Lastly, for the override function, objects 2360h **AO Override Input Source** and 2361h **AO Override Input Number** are used.

When using any control source as the X-Axis input to a function block, the corresponding scaling limits are defined as per Table 17. It is the responsibility of the user to make sure that the scaling objects for any function block are setup appropriately depending on the source selected for the X-Axis input.

Note that for the Outputs, the actual objects for the scaling (7320h, 7322h, 6302h) should be edited to match the objects defined in this table when the control source is changed. Note that when changing the Control Source for a given output, the Scaling 1 and Scaling 2 parameters will automatically be set to pre-defined defaults if object 5550h **Enable Automatic Updates** is set to TRUE.

Control Source	7320h Scaling 1	7322h Scaling 2	6302h Dec Digits
CANopen® Message – Num 1 to 12	7321h	7323h	6332h
CANopen® Message – Num 13 to 22	2520h	2522h	2502h
Analog Input Block	7120h	7122h	2102h
Constant Function Block	0.0 [%]	100.0 [%]	1 [0.1%]
PID Control Function Block	0%	100%	1 (fixed)
Lookup Table yz Function Block (where yz = 01 to 9)	0 or lowest from 3yz6h <sup>(*)</sup>	100 or highest from 3yz6h <sup>(**)</sup>	3yz3h
Set-Reset Latch	0 [OFF]	1 [ON]	0 (fixed)
Conditional Logic	0 [OFF]	1 [ON]	0 (fixed)
Mathematical Function	4021h	4023h	4032h
Programmable Logic Function	0%	100%	1 (fixed)
Output Commanded Field Value	7320h	7322h	6302h
Output Feedback Field Value	7320h	7322h	6302h
Power Supply Measured	N/A	N/A	1 (fixed)
Processor Temperature Measured	N/A	N/A	1 (fixed)

(\*) - Whichever value is smaller; (\*\*) - Whichever value is larger

**Table 17 – Scaling Limits per Control Source**

As shown in Figure 11, the Output FV will be calculated based on the FV scaling selected. Since 7321h represents the value at or below the lowest control input received, it represents the minimum field value that will be applied at the output. Similarly, 7323h represents the maximum FV that will be applied.

While (7320h < 7322h) must always hold true, in order to get an inverse response (i.e. output decreases as the input increased), simply set 7321h higher than 7323h.

In general, the profile shown in Figure 11 holds true. However, in some cases it may be desired that the minimum offset not be applied when the value is outside of the range, i.e. when using a joystick profile with a deadband. For this reason, object 2342h **AO Control Response** has the options shown in Table 18.

Value	Meaning
0	Single Output Profile (Figure 11)
1	<b>Output OFF below Scaling 1 PV</b>
2	Output OFF above Scaling 2 PV

**Table 18 – Object 2342 - AO Control Response Options**

Enable and Override inputs have been mentioned several times already. By default, neither inputs are used (control sources are set to 0=Ignore), but they can be activated for safety interlocks or other more complex applications. Table 19 shows the options for object 2352h **AO Enable Response**.

**Note that the Enable and Override functionalities do not apply the output delay, only the Control Response uses the delay.**

Value	Meaning
0	Enable When ON, Else Shut OFF
1	Enable When ON, Else Ramp OFF
2	Enable When ON, Else Keep Last Value
<b>3</b>	<b>Enable When OFF, Else Shut OFF</b>
4	Enable When OFF, Else Ramp OFF
5	Enable When OFF, Else Keep Last Value

**Table 19 – Object 2352h - AO Enable Response Options**

Table 20 shows options for object 2362h **AO Override Response** respectively. In both cases, the default responses are bolded. When the override is applied, the output is driven to the value defined in object 2300h, **AO Override FV**.

Value	Meaning
<b>0</b>	<b>Override When ON</b>
1	Override When OFF

**Table 20 – Object 2362h - AO Override Response Options**

When an input to the output block goes into an error condition, object 6340 **AO Fault Mode** determines how the output will respond, per Table 21. By default, the output will be driven to the value defined in object 7341h **AO Fault FV**.

Value	Meaning
0	Shutoff
<b>1</b>	<b>Apply Pre-Defined FV</b>
2	Maintain Last State

**Table 21 – Object 6340 - AO Fault Mode Options**

The controller applies the logic shown in Figure 6 when evaluating what output FV to apply. Under normal conditions, i.e. when the control input is driving the output as shown in the green box, there are ramping objects that can be applied to soften the output response. Object 2330h **AO Ramp Up** and object 2331 **AO Ramp Down** are both millisecond numbers that define how long it will take to ramp from AO Scaling 1 FV to AO Scaling 2 FV.

**Please note:** Proportional outputs share **Object 2380h PWM Output Frequency** with each other in 3 groups of 4 proportional outputs. Proportional output 1 shares a timer with outputs 2, 3, and 11. And proportional output 4 shares a timer with outputs 5, 6, and 12. If any of the outputs in these groups are configured to **Proportional Current** or **Digital Hotshot Current**, the **Object 2380h PWM Output Frequency** is set to 25kHz for the entire group.

To change the frequency of Outputs 1, 2, 3, and 11, object 2380h subindex 1 (Output 1) must be changed. The other subindexes will update automatically to the new frequency.

To change the frequency of Outputs 4, 5, 6, and 12, object 2380h subindex 4 (Output 4) must be changed. The other subindexes will update automatically to the new frequency.

Outputs 7, 8, 9, and 10 Can be configured Individually.

Object 2320h **AO Dither Frequency** and object 2321h **AO Dither Amplitude** are only applicable with current output types. The dither is a low frequency signal that is superimposed on-top of the high frequency output. While the dither frequency will match exactly what is in object 2320h, the exact amplitude of the dither will depend on the properties of the coil. When adjusting 2321h, select a value that is high enough to ensure an immediate response to the coil to small changes in the control inputs, but not so large as to effect the accuracy or stability of the output. ***If 2321h is set to zero, dithering is disabled.*** The dither frequency, as for the output frequency, is shared between the outputs in each bank. The dither amplitude, however, is independent of one another.

There are three other objects associated with the close-loop PID control of the current through an inductive load. These objects have been factory calibrated and ***should not be changed.*** However, the user does have access to these objects in the unlikely case that they should be adjusted. These objects are 2382h, **AO Current PID Proportional Gain**, 2383h **AO Current PID Integral Time**, and 2384h **AO Current PID Derivative Time**. *These objects must not be confused with PID objects in the PID function block which operates independently of the close-loop current control.*

In addition to the read-only mappable object 7330h **AO Output Field Value** (as represented by the green box above), there is another object 2370h **AO Feedback FV**, also read-only mappable. This object reflects the actual measured value at the output. It is also used to detect and flag an error if there is an open or short circuit at the output.

Object 2371h **AO Feedback Current FV** is similar to object 2370h **AO Feedback FV**, but will always measure feedback current regardless of output mode. This object has a fixed resolution and always contains the measured feedback current in milliamps.

If object 2310h **AO Error Detect Enable** is set to TRUE, then the absolute value between the desired output FV (7330h) and the measured feedback (2370h) is compared to 2311h **AO Error Clear Hysteresis**. If the difference between the target and the actual exceeds the hysteresis value, then a fault is present. Since both open and short circuits read close to zero feedback, a signal is also sent to the processor whenever a short (to either GND or +Vcc) has occurred.

The controller will then flag an “Open Circuit” fault. If the flag stays active for the 2312h **AO Error Reaction Delay** time, then an appropriate EMCY message will be added to object 1003h **Pre-Defined Error Field**. The application will react to the EMCY message as defined by object 1029h **Error Behaviour** at the sub-index corresponding to an Input Fault. Refer to section 2.2.4 and 3.2.13 for more information about objects 1003h and 1029h, including the complete list of EMCY messages.

Once the absolute difference between the target and feedback FV comes back with the tolerance defined in 2311h, the error flag is cleared. This means that when the output is commanded off, the flags are automatically reset, since the target and feedback are now both zero.

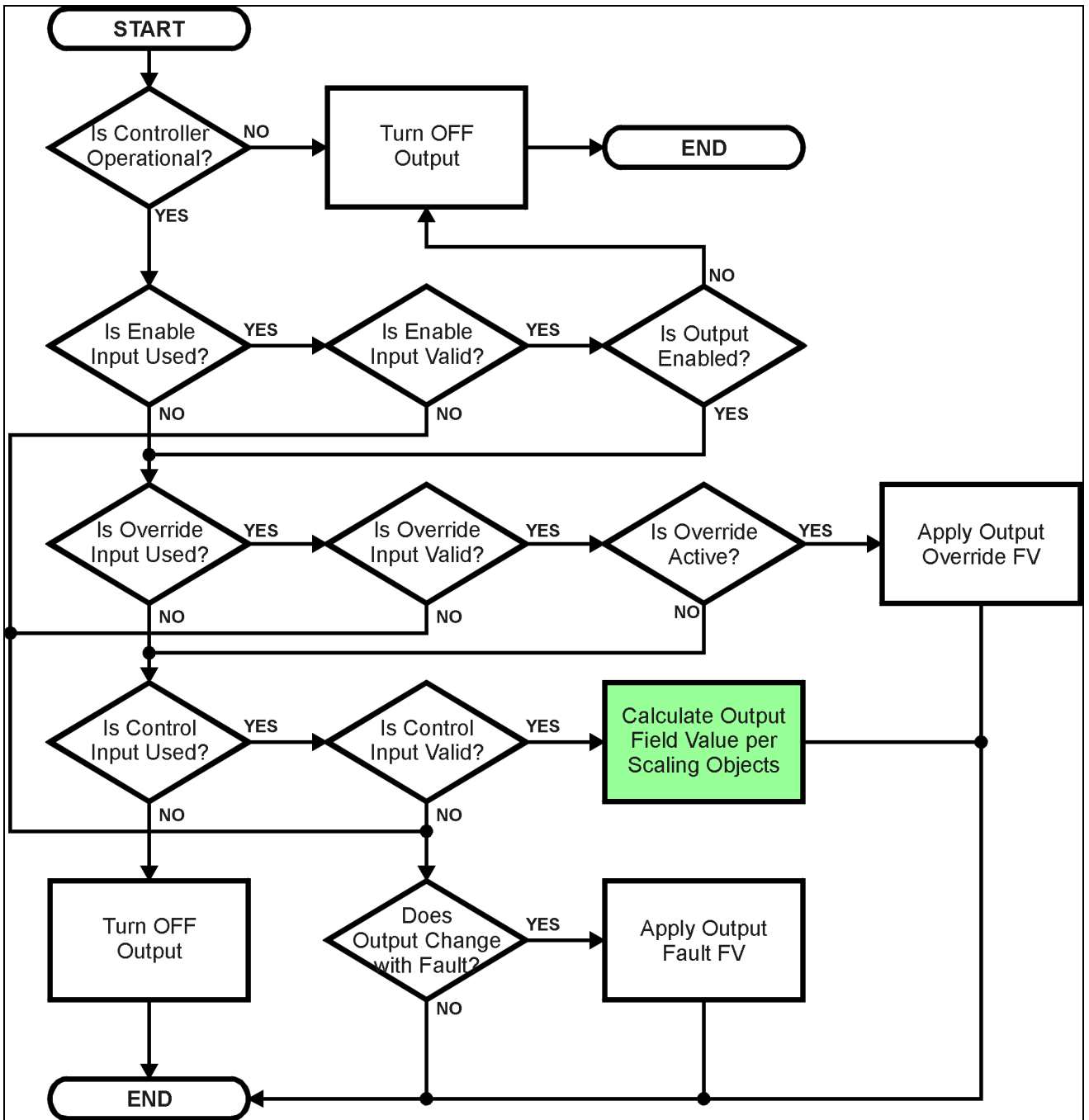

Figure 12 – Analog Output Logic Flowchart

## 1.7. PID Control Function Block

The PID control (PID) function blocks are not used by default.

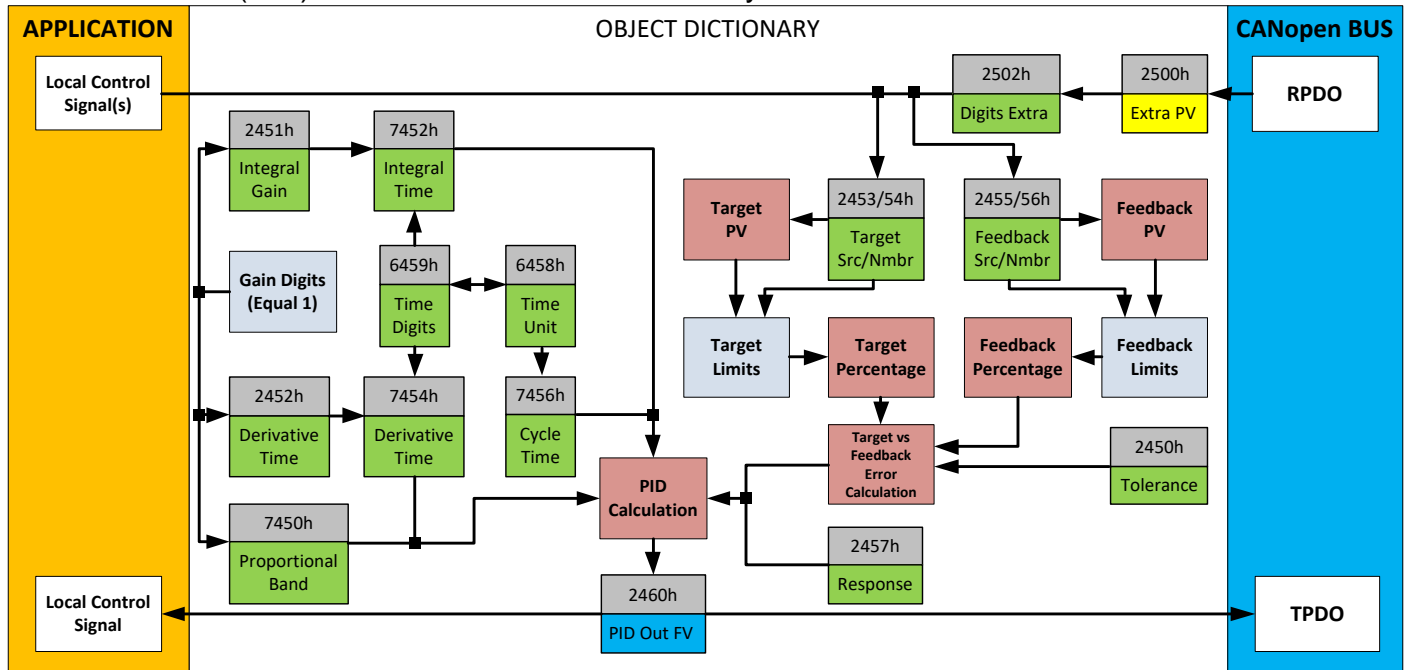

Figure 13 – PID Control Objects

As with the output function block, the PID control function has control inputs associate with it that can be mapped to the output from any other function block. Objects 2453h **PID Target Source** and 2454h **PID Target Number** define what value the PID loop will attempt to maintain. For example, in the case of a setpoint (fixed) control application, this input can be mapped to one of object 5010h, a Constant FV. In this case, since there is no pre-defined range associated with a constant (see Table 17), the scaling limits will be set equal to those of the feedback input. Otherwise, the target input units do not have to match the feedback units, so long as they are scaled relative to one another.

Objects 2355h **PID Feedback Source** and 2356h **PID Feedback Number** define the close-loop input. Both the target and feedback use Tables 15 and 16 as the available options. Both inputs are normalized to a percentage based on the associated scaling limits as defined in Table 17.

Object 2450h **PID Tolerance** defines the acceptable difference between the target and feedback, as a percentage, whereby an absolute difference smaller than this is treated as a 0% error.

Unless both the target and feedback inputs have legitimate control sources selected, the PID loop is disabled. When active, however, the PID algorithm will be called every 7456h **PID Cycle Time**, the default being every 10ms.

Object 6458h **PID Physical Unit Timing** is a read-only value and is defined in Seconds. The default value for object 6459h **PID Decimal Digits Timing** is 3, which means the object 7456h, along with other PID timing objects, are interpreted in milliseconds. Other time objects associated with the PID control are 7452h **PID Integral Action Time (Ti)** and 7454h **PID Derivative Action Time (Td)**.

No time related objects use a fixed resolution of 1 decimal digit. These objects include 7450h **PID Proportional Band (G)**, 2450h **PID Tolerance**, 2451h **PID Integral Gain (Ki)**, and 2454h **PID Derivative Gain (Kd)**.



By default, the PID loop is assumed to be controlling a single output which will increase/decrease as the feedback over/undershoots the target. However, some systems may require a push-pull response where one output comes on when over target, and the other when under. Object 2457h **PID Control Response** allows the user to select the response profile as needed from Table 22.

Value	Meaning
0	Single Output
1	On When Over Target
2	On When Below Target

**Table 22 – PID Control Response Options**

The PID algorithm used is shown below, with names in red being the object variables. The result  $PIDOutput_k$  is written to the read-only mappable object 2460h **PID Output Field Value** and is interpreted as a percentage value with 1 decimal place resolution. It can be used as the control source for another function block, i.e. one of the analog outputs.

$$\begin{aligned}
 T &= Loop\_Update\_Rate * 0.001 \\
 P\_Gain &= G \\
 I\_Gain &= G * K_i * T / T_i \\
 D\_Gain &= G * K_d * T_d / T \\
 \text{Note: If } T_i \text{ is zero, } I\_Gain &= 0 \\
 Error_k &= Target - Feedback \\
 ErrorSum_k &= ErrorSum_{k-1} + Error_k \\
 P_k &= Error_k * P\_Gain \\
 I_k &= ErrorSum_k * I\_Gain \\
 D_k &= (Error_k - Error_{k-1}) * D\_Gain \\
 PIDOutput_k &= P_k + I_k + D_k
 \end{aligned}$$

**Figure 14 – PID Control Algorithm**

Each system will have to be tuned for the optimum output response. Response times, overshoots and other variables will have to be decided by the customer using an appropriate PID tuning strategy.

## 1.8. Lookup Table Function Block

The lookup table (LTz) function blocks are not used by default.

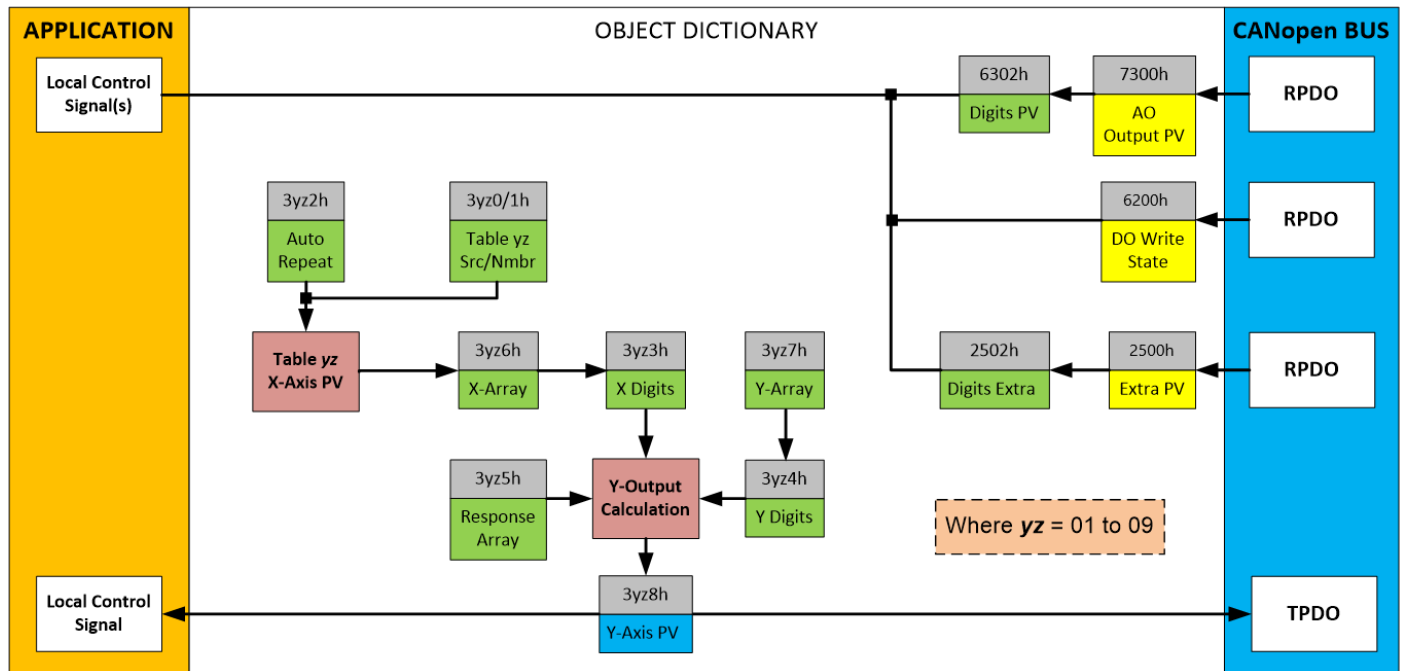

Figure 15 – Lookup Table Objects

**Lookup tables are used to give an output response of up to 10 slopes per input.** The array size of the objects 3yz5h **LTyz Point Response**, 3yz6h **LTyz Point X-Axis PV** and 3yz7h **Point Y-Axis PV** shown in the block diagram above is therefore 11.

Note: If more than 10 slopes are required, a Programmable Logic Block can be used to combine up to three tables to get 30 slopes, as is described in Section 1.8.

A parameter that will affect the function block is object **3yz5h sub-index 1** which defines the “**X-Axis Type**”. By default, the tables have a ‘*Data Response*’ output (0). Alternatively, it can be selected as a ‘*Time Response*’ (1). ,

There are two (or three) other key parameters that will affect how this function block will behave depending on the “**X-Axis Type**” chosen. If chosen ‘*Data Response*’, then the objects 3yz0h **Lookup Table yz Input X-Axis Source** and 3yz1h **Lookup Table yz Input X-Axis Number** together define the control source for the function block. When it is changed, the table values in object 3yz6h need to be updated with new defaults based on the X-Axis source selected as described in Tables 15 and 16. If however, the “**X-Axis Type**” is chosen to be ‘*Time Response*’, an additional parameter is taken into consideration - object 3yz2h, **Lookup Table yz Auto Repeat**. These will be described in more detail in Section 1.7.4.

### 1.8.1. X-Axis, Input Data Response

In the case where the “X-Axis Type” = ‘Data Response’, the points on the X-Axis represents the data of the control source.

However, should the minimum input be less than zero, for example a resistive input that is reflecting temperature in the range of -40°C to 210°C, then the “LTz Point X-Axis PV sub-index 1” will be set to the minimum instead, in this case -40°C.

The constraint on the X-Axis data is that the next index value is greater than or equal to the one below it, as shown in the equation below. Therefore, when adjusting the X-Axis data, it is recommended that X<sub>11</sub> is changed first, then lower indexes in descending order.

$$\text{MinInputRange} \leq X_1 \leq X_2 \leq X_3 \leq X_4 \leq X_5 \leq X_6 \leq X_7 \leq X_8 \leq X_9 \leq X_{10} \leq X_{11} \leq \text{MaxInputRange}$$

As stated earlier, MinInputRange and MaxInputRange will be determined by the scaling objects associated with X-Axis Source that has been selected, as outlined in Table 17.

### 1.8.2. Y-Axis, Lookup Table Output

**By default, it is assumed that the output from the lookup table function block will be a percentage value in the range of 0 to 100.**

In fact, so long as all the data in the Y-Axis is  $0 \leq Y[i] \leq 100$  (where  $i = 1$  to 11) then other function blocks using the lookup table as a control source will have 0 and 100 as the Scaling 1 and Scaling 2 values used in linear calculations shown in Table 17.

However, the Y-Axis has no constraints on the data that it represents. This means that inverse or increasing/decreasing or other responses can be easily established. **The Y-Axis does not have to be a percentage output but could represent full scale process values instead.**

In all cases, the controller looks at the **entire range** of the data in the Y-Axis sub-indexes and selects the lowest value as the MinOutRange and the highest value as the MaxOutRange. So long as they are not both within the 0 to 100 range, they are passed directly to other function blocks as the limits on the lookup table output. (i.e. Scaling 1 and Scaling 2 values in linear calculations.)

Even if some of the data points are ‘Ignored’ as described in Section 1.7.3, they are still used in the Y-Axis range determination. If not all the data points are going to be used, it is recommended that Y<sub>10</sub> be set to the minimum end of the range, and Y<sub>11</sub> to the maximum first. This way, the user can get predictable results when using the table to drive another function block, such as an analog output.

### 1.8.3. Point To Point Response

By default, all six lookup tables have a simple linear response from 0 to 100 in steps of 10 for both the X and Y axes. For a smooth linear response, each point in the 30z5h **LTz Point Response** array is setup for a ‘Ramp To’ output.

Alternatively, the user could select a ‘Step To’ response for 30z4h, where  $N = 2$  to 11. In this case, any input value between  $X_{N-1}$  to  $X_N$  will result in an output from the lookup table function block of  $Y_N$ . (Recall: LTz Point Response sub-index 1 defines the X-Axis type)

Figure 16 shows the difference between these two response profiles with the default settings.

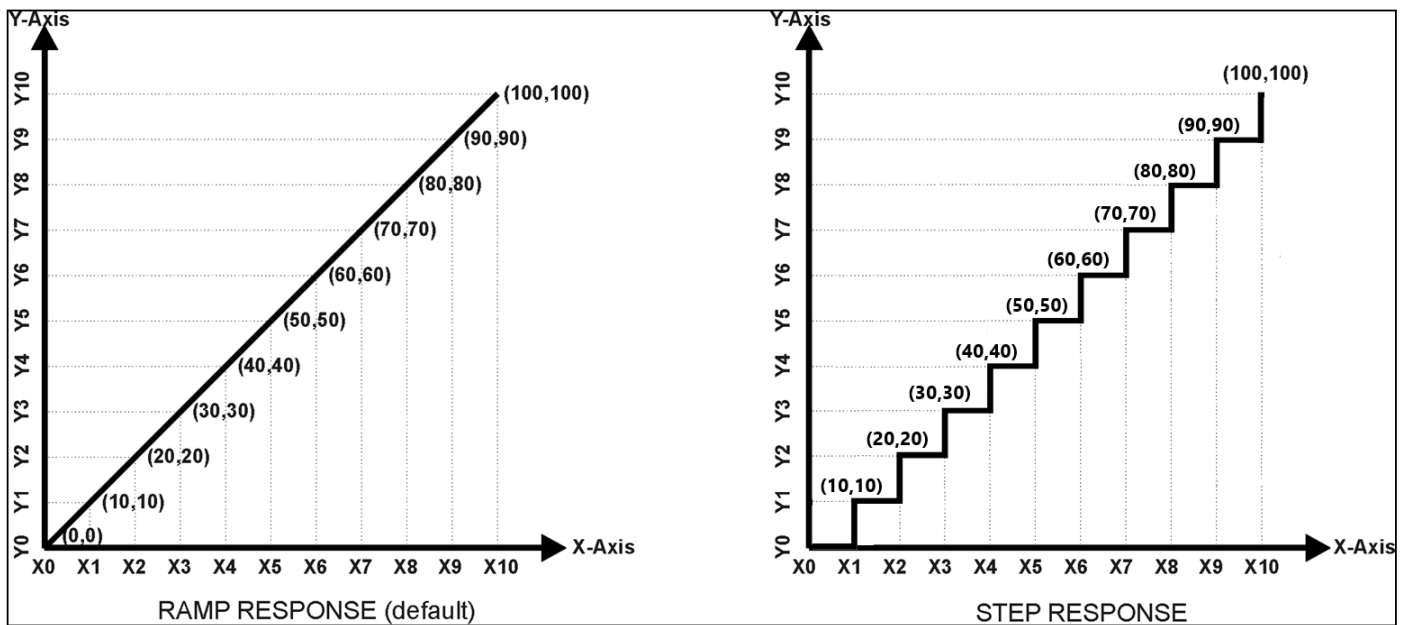

Figure 16 – Lookup Table Defaults with Ramp and Step Responses

Lastly, any point except (1,1) can be selected for an 'ignore' response. If **LTz Point Response sub-index N** is set to ignore, then all points from (X<sub>N</sub>, Y<sub>N</sub>) to (X<sub>11</sub>, Y<sub>11</sub>) will also be ignored. For all data greater than X<sub>N-1</sub>, the output from the lookup table function block will be Y<sub>N-1</sub>.

A combination of 'Ramp To', 'Jump To' and 'Ignore' responses can be used to create an application specific output profile. An example of where the same input is used as the X-Axis for two tables, but where the output profiles 'mirror' each other for a deadband joystick response is shown in Figure 17. The example shows a dual slope percentage output response for each side of the deadband, but additional slopes can be easily added as needed. (Note: In this case, since the analog outputs are responding directly to the profile from the lookup tables, both would have object 2342h AO Control Response set to a 'Single Output Profile.')

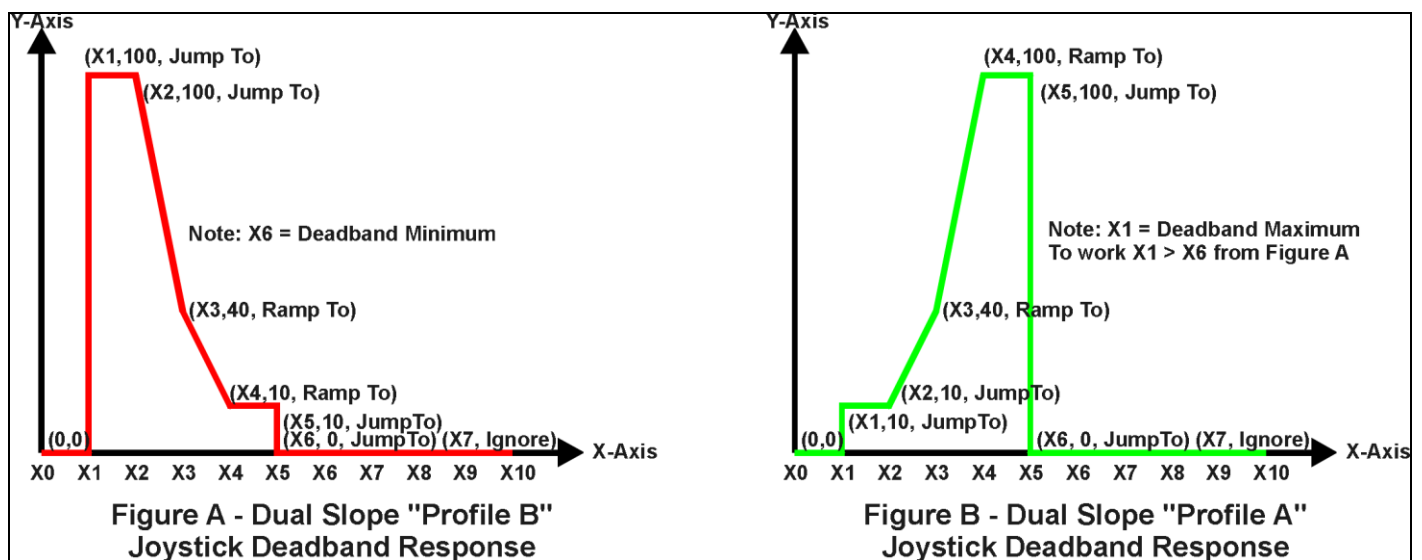

Figure 17 – Lookup Table Examples to Setup for Dual-Slope Joystick Deadband Response

To summarize, Table 23 outlines the different responses that can be selected for object 30z4h, both for the X-Axis type and for each point in the table.

Sub-Index	Value	Meaning
1	0	Data Response (X-Axis Type)
2 to 11		Ignore (this point and all following it)
1	1	Time Response (X-Axis Type)
2 to 11		Ramp To (this point)
1	2	N/A (not an allowed option)
2 to 11		Jump To (this point)

**Table 23 – LTyz Point Response Options**

#### 1.8.4. X-Axis, Time Response

As mentioned in Section 1.5, a lookup table can also be used to get a custom output response where the “**X-Axis Type**” is a ‘*Time Response*’. When this is selected, the X-Axis now represents time, in units of milliseconds, while the Y-Axis still represents the output of the function block.

With this response, the sequence will start depending on two parameters:

- **Lookup Table yz Input X-Axis Source** Object 3yz0h and;
- **Lookup Table yz Auto Repeat** Object 3yz2h

By default, the “Auto Repeat” object is set to FALSE (0). In this case, the lookup table will react in the following way:

The X-Axis control source is treated as a digital input. When the control input is ON, the output will be changed over a period of time based on the profile in the lookup table. Once the profile has finished (i.e. reached index 11, or an ‘Ignored’ response), the output will remain at the last output at the end of the profile until the control input turns OFF.

**However**, when the “Auto Repeat” object is set to TRUE (1), the lookup table will react in the following way:

When the control input is ON, the output will be changed over a period of time based on the profile in the lookup table. Once the profile has finished (i.e. reached index 11, or an ‘Ignored’ response), the lookup table will revert back to the first point in the table and Auto Repeat the sequence. This will continue for as long as the input remains ON. Once the input turns OFF, the lookup table sequence will stop, and the output of the lookup table is zero.

**Note:** When the control input is OFF, the output is always at zero. When the input comes ON, the profile will **ALWAYS** start at position (X<sub>1</sub>, Y<sub>1</sub>) which is 0 output for 0ms.

When using the lookup table to drive an output based on **time**, it is mandatory that objects 2330h **Ramp Up** and 2331h **Ramp Down** in the analog output function block be set to **zero**. Otherwise, the output result will not match the profile as expected. Recall, also, that the AO scaling should be set to match the Y-Axis scaling of the table in order to get a 1:1 response of AO Output FV versus LTyz Output Y-Axis PV.

In a time response, the data in object 30z6h **LTyp Point X-Axis PV** is measured in milliseconds, and object 3yz3h **LTyp X-Axis Decimal Digits PV** is automatically set to 0. A minimum value of 1ms must be selected for all points other than sub-index 1 which is automatically set to [0,0]. The interval time between each point on the X-axis can be set anywhere from 1ms to 24 hours [86,400,000 ms].

### 1.9. Programmable Logic Function Block

The programmable logic blocks (LB(x-3)) functions are not used by default.

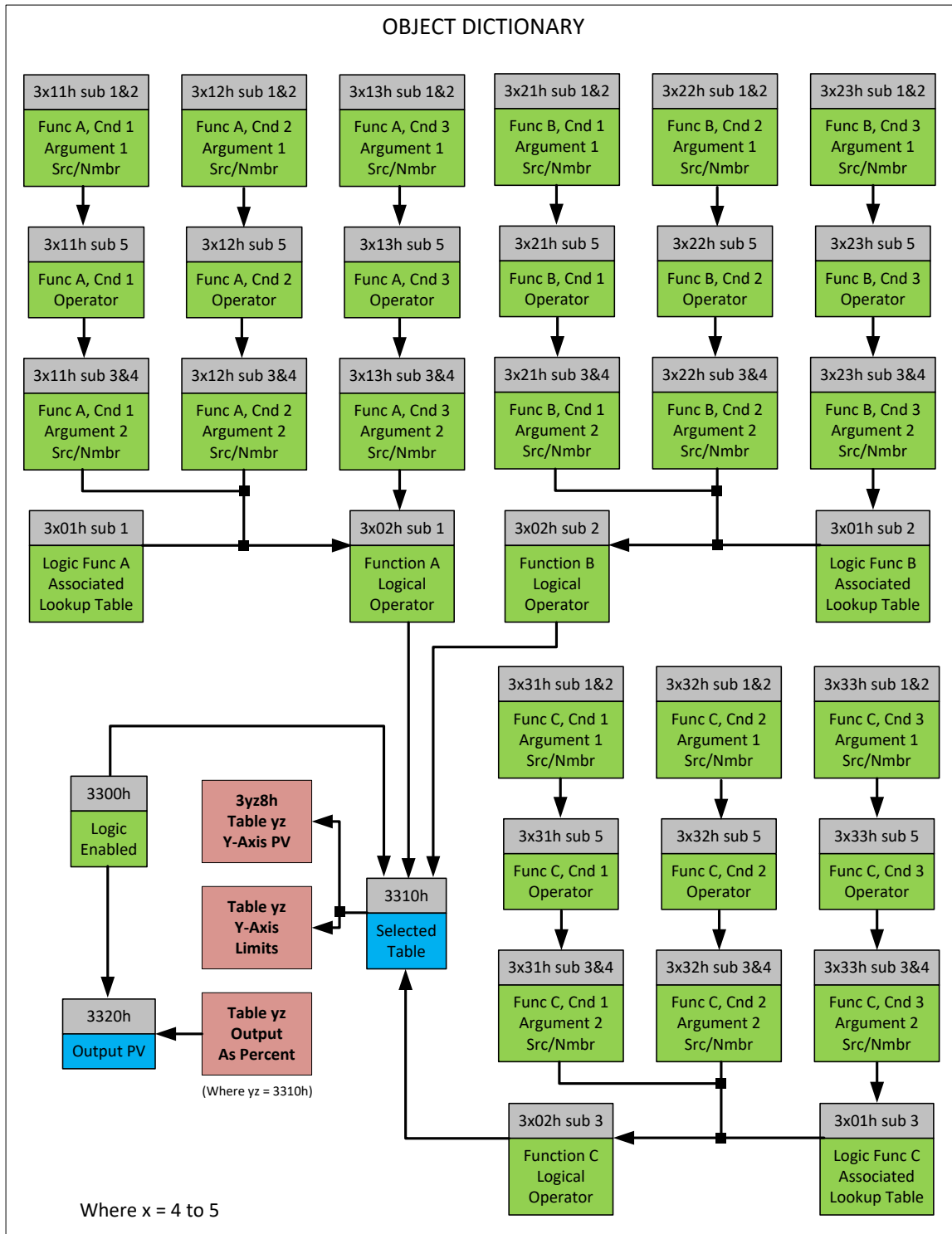

Figure 18 – Logic Block Objects

This function block is obviously the most complicated of them all, but very powerful. Any LBx (where X= 4 to 6) can be linked with up to three lookup tables, any one of which would be selected only under given conditions. Any three tables (of the available 9) can be associated with the logic, and which ones are used is fully configurable on object 3x01 **LB(x-3) Lookup Table Number**.

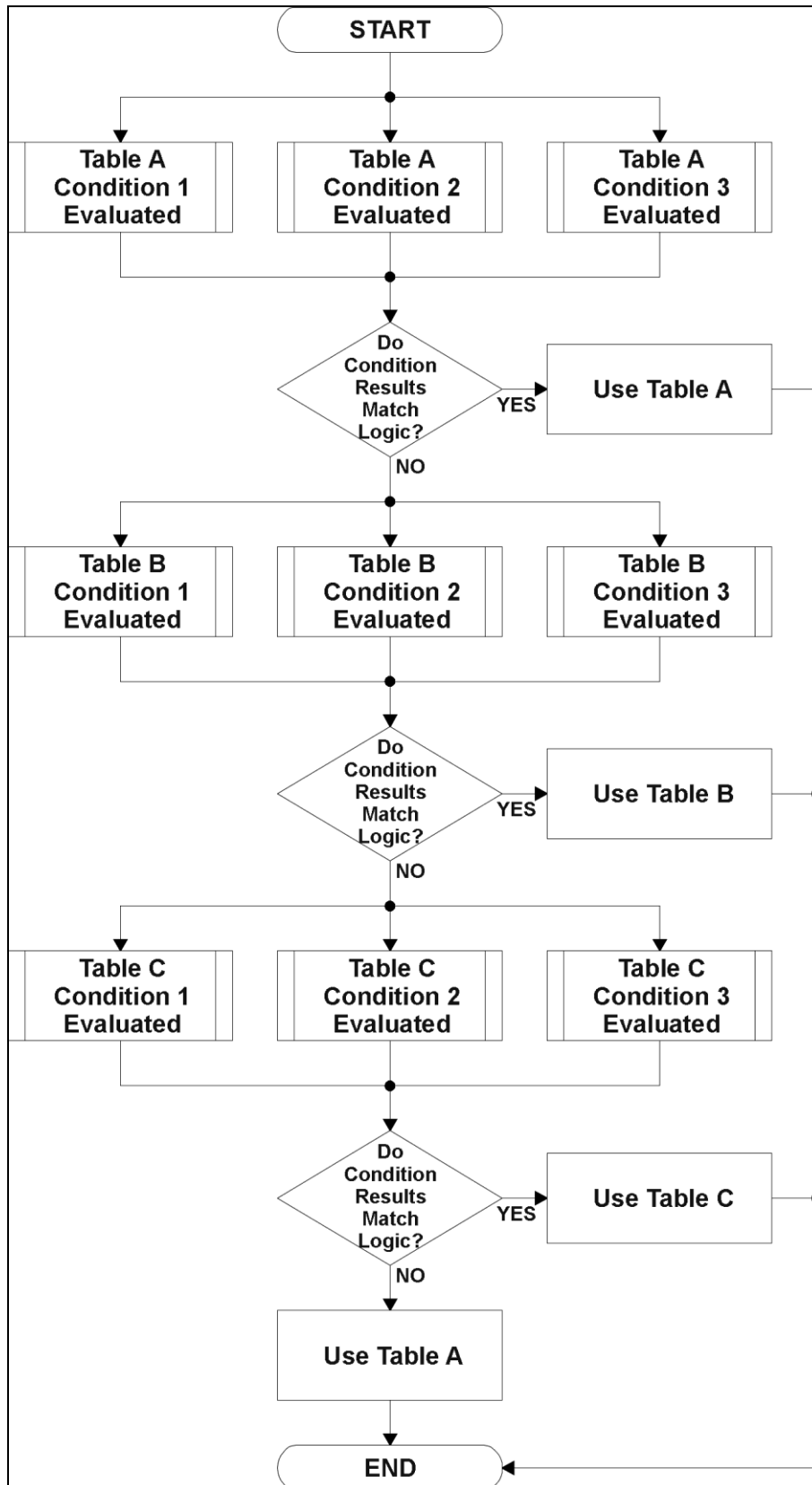

Figure 19 – Logic Block Flowchart

Should the conditions be such that a particular table (A, B or C) has been selected as described in Section 1.8.2, then the output from the selected table, at any given time, will be passed directly to LB(x-3)'s corresponding sub-index X in read-only mappable object 3320h **Logic Block Output PV**. The active table number can read from read-only object 3310h **Logic Block Selected Table**.

**Note:** In this document, the term *LB(x-3)* refers to Logic Blocks 1 to 4. Due to the CANopen® Object indices, Logic Block 1 begins at 3401h where x, in this case, is 4.

Therefore, an LBx allows up to three different responses to the same input, or three different responses to different inputs, to become the control for another function block, such as an analog output. Here, the **“Control Source”** for the reactive block would be selected to be the *‘Programmable Logic Function Block,’* as described in Section 1.5.

In order to enable any one of logic blocks, the corresponding sub-index in object 3300h **Logic Block Enable** must be set to TRUE. They are all disabled by default.

Logic is evaluated in the order shown in Figure 19. Only if a lower indexed table (A, B, C) has not been selected will the conditions for the next table be looked at. **The default table is always selected as soon as it is evaluated. It is therefore required that the default table always be the highest index in any configuration.**

### Conditions Evaluation

The first step in determining which table will be selected as the active table is to first evaluate the conditions associated with a given table. Each table has associated with it up to three conditions that can be evaluated. Conditional objects are custom DEFSTRUCT objects defined as shown in Table 24.

Index	Sub-Index	Name	Data Type
3xyz*	0	Highest sub-index supported	UNSIGNED8
	1	Argument 1 Source	UNSIGNED8
	2	Argument 1 Number	UNSIGNED8
	3	Argument 2 Source	UNSIGNED8
	4	Argument 2 Number	UNSIGNED8
	5	Operator	UNSIGNED8

\* Logic Block X Function Y Condition Z, where X = 4 to 6, Y = A, B or C, and Z = 1 to 3

**Table 24 – LB(x-3) Condition Structure Definition**

Objects 3x11h, 3x12h and 3x13h are the conditions evaluated for selecting Table A.  
 Objects 3x21h, 3x22h and 3x23h are the conditions evaluated for selecting Table B.  
 Objects 3x31h, 3x32h and 3x33h are the conditions evaluated for selecting Table C.

Argument 1 is always a logical output from another function block, as listed in Table 26. As always, the input is a combination of the functional block objects 3xyzh sub-index 1 **“Argument 1 Source”** and **“Argument 1 Number.”**

Argument 2 on the other hand, could either be another logical output such as with Argument 1, OR a constant value set by the user. To use a constant as the second argument in the operation, set **“Argument 2 Source”** to *‘Constant Function Block’*, and **“Argument 2 Number”** to the desired sub-index. When defining the constant, make sure it uses the same resolution (decimal digits) as the Argument 1 input.



Argument 1 is evaluated against Argument 2 based on the “**Operator**” selected in sub-index 5 of the condition object. The options for the operator are listed in Table 25, and the default value is always ‘*Equal*’ for all condition objects.

Value	Meaning
0	=, Equal
1	!=, Not Equal
2	>, Greater Than
3	>=, Greater Than or Equal
4	<, Less Than
5	<=, Less Than or Equal

**Table 25 – LB(x-3) Condition Operator Options**

By default, both arguments are set to ‘*Control Source Not Used*’ which disables the condition, and automatically results in a value of N/A as the result. Although is generally considered that each condition will be evaluated as either TRUE or FALSE, the reality is that there could be four possible results, as described in Table 26.

Value	Meaning	Reason
0	False	(Argument 1) Operator (Argument 2) = False
1	True	(Argument 1) Operator (Argument 2) = True
2	Error	Argument 1 or 2 output was reported as being in an error state
3	Not Applicable	Argument 1 or 2 is not available (i.e. set to ‘ <i>Control Source Not Used</i> ’)

**Table 26 – LB(x-3) Condition Evaluation Results**

### 1.9.1. Table Selection

In order to determine if a particular table will be selected, logical operations are performed on the results of the conditions as determined by the logic in Section 1.8.1. There are several logical combinations that can be selected, as listed in Table 27. The default value for object 3x02h **LB(x-3) Function Logical Operator** is dependent on the sub-index. For sub-index 1 (Table A) and 2 (Table B), the ‘*Cnd1 And Cnd2 And Cnd3*’ operator is used, whereas sub-index 3 (Table C) is setup as the ‘*Default Table*’ response.

Value	Meaning
0	Default Table
1	Cnd1 And Cnd2 And Cnd3
2	Cnd1 Or Cnd2 Or Cnd3
3	(Cnd1 And Cnd2) Or Cnd3
4	(Cnd1 Or Cnd2) And Cnd3

**Table 27 – LB(x-3) Function Logical Operator Options**

Not every evaluation is going to need all three conditions. The case given in the earlier section, for example, only has one condition listed, i.e. that the Engine RPM be below a certain value. Therefore, it is important to understand how the logical operators would evaluate an Error or N/A result for a condition, as outlined in Table 28.

**Note: N/A Corresponds to input source Not Selected (i.e., control source = 0).**

If the result of the function logic is TRUE, then the associated lookup table (see object 4x01h) is immediately selected as the source for the logic output. No further conditions for other tables are evaluated. For this reason, the *Default Table* should always be setup as the highest letter table being used (A, B or C) If no default response has been setup, the Table A automatically becomes the default when no conditions are true for any table to be selected. This scenario should be avoided whenever possible so as to not result in unpredictable output responses.

The table number that has been selected as the output source is written to sub-index X of read-only object 3310h **Logic Block Selected Table**. This will change as different conditions result in different tables being used.

<b>Logical Operator</b>	<b>Select Conditions Criteria</b>
Default Table	Associated table is automatically selected as soon as it is evaluated.
Cnd1 And Cnd2 And Cnd3	<p><b>Should be used when two or three conditions are relevant, and all must be True to select the table.</b></p> <p>If any condition equals False or Error, the table is not selected. An N/A is treated like a True. If all three conditions are True (or N/A), the table is selected.</p> <p>If((Cnd1==True) &amp;&amp;(Cnd2==True)&amp;&amp;(Cnd3==True)) Then Use Table</p>
Cnd1 Or Cnd2 Or Cnd3	<p><b>Should be used when only one condition is relevant. Can also be used with two or three relevant conditions.</b></p> <p>If any condition is evaluated as True, the table is selected. Error or N/A results are treated as False</p> <p>If((Cnd1==True)    (Cnd2==True)    (Cnd3==True)) Then Use Table</p>
(Cnd1 And Cnd2) Or Cnd3	<p><b>To be used only when all three conditions are relevant.</b></p> <p>If both Condition 1 and Condition 2 are True, OR Condition 3 is True, the table is selected. Error or N/A results are treated as False</p> <p>If( ((Cnd1==True)&amp;&amp;(Cnd2==True))    (Cnd3==True) ) Then Use Table</p>
(Cnd1 Or Cnd2) And Cnd3	<p><b>To be used only when all three conditions are relevant.</b></p> <p>If Condition 1 And Condition 3 are True, OR Condition 2 And Condition 3 are True, the table is selected. Error or N/A results are treated as False</p> <p>If( ((Cnd1==True)  ((Cnd2==True)) &amp;&amp; (Cnd3==True) ) Then Use Table</p>

**Table 28 – LB(x-3) Conditions Evaluation Based on Selected Logical Operator**

### 1.9.2. Logic Block Output

Recall that Table Y, where Y = A, B or C in the LB(x-3) function block does NOT mean lookup table 1 to 3. Each table has object 3x01h LB(x-3) **Lookup Table Number** which allows the user to select which lookup tables they want associated with a particular logic block. The default tables associated with each logic block are listed in Table 29.

<b>Programmable Logic Block Number</b>	<b>Table A – Lookup Table Block Number</b>	<b>Table B – Lookup Table Block Number</b>	<b>Table C – Lookup Table Block Number</b>
1	1	2	3
2	4	5	6
3	7	8	9
4	10	11	12

**Table 29 – LB(x-3) Default Lookup Tables**

If the associated Lookup Table YZ (where YZ equals 3310h sub-index X) does not have an “**X-Axis Source**” selected, then the output of LB(x-3) will always be “Not Available” so long as that table is selected. However, should LTyZ be configured for a valid response to an input, be it Data or Time, the output of the LTyZ function block (i.e. the Y-Axis data that has been selected based on the X-Axis value) will become the output of the LB(x-3) function block so long as that table is selected.

The LB(x-3) output is always setup as a percentage, based on the range of the Y-Axis for the associated table (see Section 1.7.2) It is written to sub-index X of read-only object 3320h **Logic Block Output PV** with a resolution of 1 decimal place.

### 1.10. Math Function Block

There are six mathematic function blocks that allow the user to define basic algorithms. Math function block Z = 1 to 6 will be enabled based on sub-index Z in object 4000h **Math Enable**.

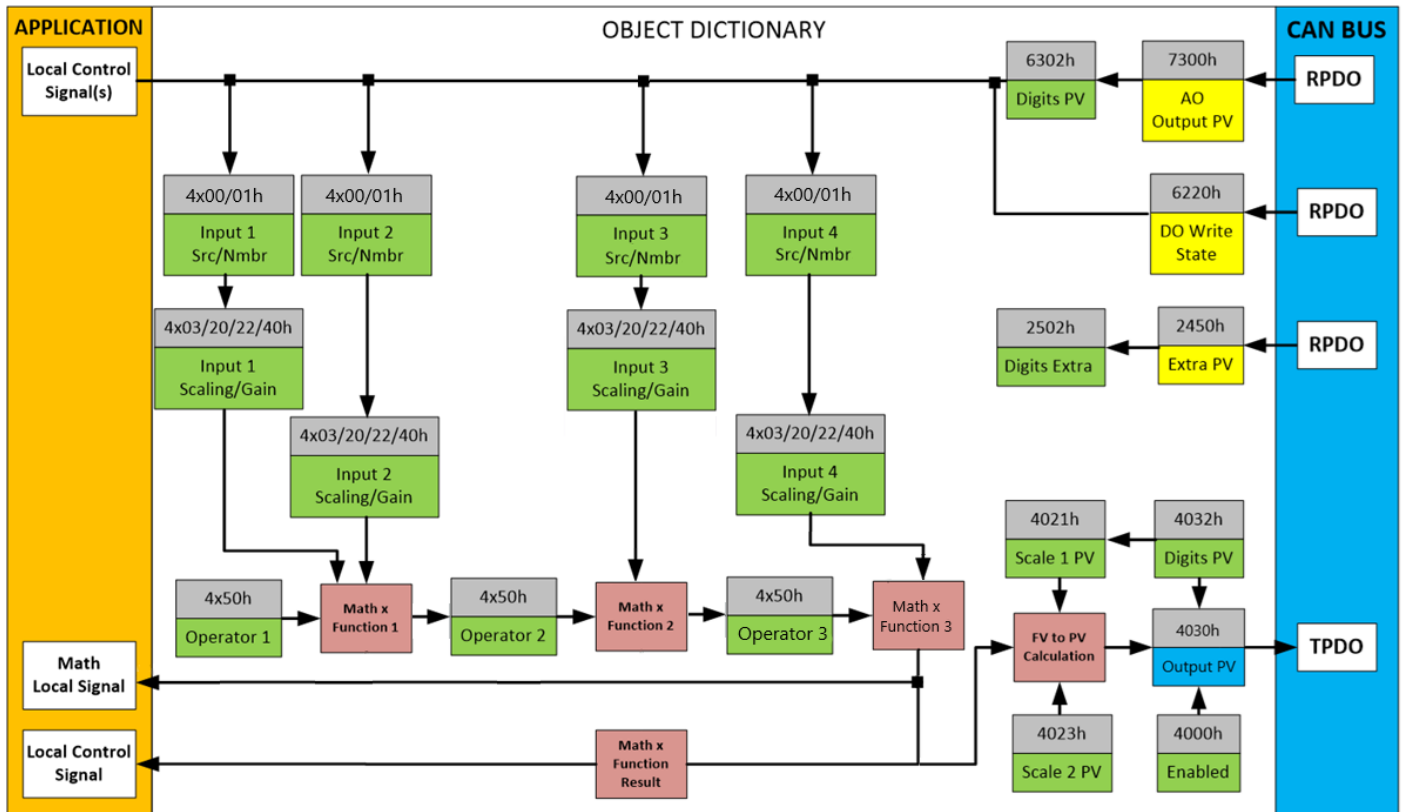

Figure 20 – Math Function Block Objects

A math function block can take up to four input signals, as listed in Table 15 in Section 1.5. Each input is then scaled according to the associated scaling and gain objects. A “Math Input X” is determined by the corresponding sub-index  $X = 1$  to 4 of the objects 4y00h **Math Y Input Source** and 4y01h **Math Y Input Number**. Here,  $y = 1$  to 6; corresponding the Math 1- Math 6.

Inputs are converted into a percentage value based on objects 4y20h **Math Y Scaling 1 FV** and 4y22h **Math Y Scaling 2 FV**. Before being used in the calculation, these objects apply the resolution shift defined by object 4y03h **Math Y Decimal Digits FV**. As with any other function block using a control source for the X-Axis in a conversion, the scaling objects should be selected to match the values in the control’s corresponding objects as per Table 17.

Calculations are performed in the order of the source/number that comes first, as shown in Figure 20. For example, if Input 1, 2 and 3 are used, and operator 1 is addition (**4y50 Math Y Operator** subindex 1 = 12), and operator 2 is multiplication (**4y50 Math Y Operator** subindex 1 = 14), the calculation would be carried out as follows:

$$\text{Result} = (\text{Input1} + \text{Input2}) * \text{Input3}$$

For additional flexibility, the user can also adjust object 4y40h **Math Y Input Gain**. This object has a fixed decimal digit resolution of 2, and a range of -100 to 100 (resulting in a gain of -1.0 to 1.0, respectively). By default, each input has a gain of 1.0.

For example, in the case where the user may want to combine two inputs such that a joystick (Input 1) is the primary control of an output, but the speed can be incremented or decremented based on a potentiometer (Input 2), it may be desired that 75% of the scale is controlled by the joystick position, while the potentiometer can increase or decrease the min/max output by up to 25%. In this case, Input 1 would have a gain of 0.75, while Input 2 uses 0.25. The resulting addition will give a command from 0 to 100% based on the combined positions of both inputs.

For each input pair, the appropriate arithmetic or logical operation is performed on the two inputs, InA and InB, according to the associated function in sub-index of InB in object 4y50h **Math Y Operator**. The list of selectable function operations is defined in Table 30.

0	=	True when InA Equals InB
1	!=	True when InA Not Equal InB
2	>	True when InA Greater Than InB
3	>=	True when InA Greater Than or Equal InB
4	<	True when InA Less Than InB
5	<=	True when InA Less Than or Equal InB
6	OR	True when InA or InB is True
7	NOR	True when InA and InB are False
8	AND	True when InA and InB are True
9	NAND	True when InA and InB are not both True
10	XOR	True when InA/InB is True, but not both
11	XNOR	True when InA and InB are both True or False
12	+	Result = InA plus InB
13	-	Result = InA minus InB
14	x	Result = InA times InB
15	/	Result = InA divided by InB
16	MIN	Result = Smallest of InA and InB
17	MAX	Result = Largest of InA and InB

**Table 30 – Object 4y50h Math Function Operators**

For Function 1, InA and InB are Math Inputs 1 and 2, respectively.

For Function 2, InA and InB are Math Inputs 3 and 4, respectively.

For logical operators (6 to 11), any SCALED input greater than or equal to 0.5 is treated as a TRUE input. For logic output operators (0 to 11), the result of the calculation for the function will always be 0 (FALSE) or 1 (TRUE).

Error data (i.e. input measured out of range) is always treated as a 0.0 input into the function.

For the arithmetic functions (12 to 17), it is recommended to scale the data such that the resulting operation will not exceed full scale (0 to 100%) and saturate the output result.

When dividing, a zero InB value will always result is a zero output value for the associated function. When subtracting, a negative result will always be treated as a zero, unless the function is multiplied by a negative one, or the inputs are scaled with a negative coefficient first.

The resulting final mathematical output calculation is in the appropriate physical units using object 4021h **Math Output Scaling 1 PV** and 4023h **Math Output Scaling 2 PV**. These objects are also considered the Min and Max values of the Math Block output and apply the resolution shift defined by object 4032h **Math Output Decimal Digits PV**. The result is written to read-only object 4030h **Math Output PV**. These scaling objects should also be taken into account when the Math Function is selected as the input source for another function block, as outlined in Table 17.

## 1.11. Conditional Logic Block

The Conditional Block compares up to four different input sources with different logical or relational operators. The result of each block can therefore only be **true** (1) or **false** (0). Figure 21 demonstrates the connections between all parameters.

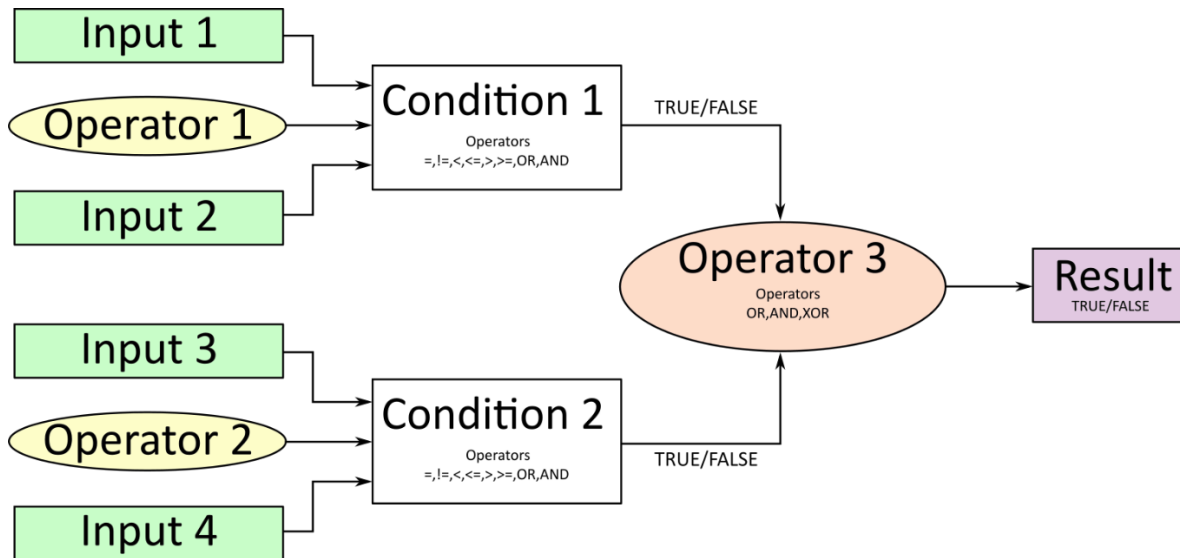

Figure 21 – Conditional Block Diagram

Each **Conditional Block [x]** offers two conditions, which are determined according to the parameters set in **Object 4Bx1h** (Condition 1) and **Object 4Bx2h** (Condition 2). Both use the defined operator to compare two inputs (argument 1 and argument 2), which can hold a logical value or an integer value. The output of the conditions can only be true or false and will be compared by Operator 3 with a logical operator. This comparison is the result of the Conditional Block and can control any output source. The output of the conditional blocks is held in the read-only object 4B10h **Conditional Logic Block Output PV**.

The value of each source will then be compared to each other with an operator of Table . If no source is selected, the output value of an Input will be zero. Operator 1 and Operator 2 are configured to OR by default.

Value	Meaning
0	== (True when argument 1 is equal to argument 2)
1	!= (True when argument 1 is not equal to argument 2)
2	> (True when argument 1 is greater than argument 2)
3	>= (True when Argument 1 is greater than or equal to Argument 2)
4	< (True when Argument 1 is less than Argument 2)
5	<= (True when Argument 1 is less than or equal to Argument 2)
6	OR (True when Argument 1 or Argument 2 is True)
7	NOR (True When Argument 1 and Argument 2 are False)
8	AND (True when Argument 1 and Argument 2 are True)
9	NAND (True when Argument 1 or Argument 2 are False)
10	XOR (True when Argument 1 or Argument 2 is True, but not both)
11	XNOR (True when Argument 1 is equal to Argument 2)

**Table 31 – Input Operator Options**

The Condition Operator used for the Conditional Logic Block is assigned using object 4B01h. The table above cannot be used for comparing the conditions because they can only be compared with logical operators, which are listed in Table .

Value	Meaning
0	OR (True when Argument 1 or Argument 2 is True)
1	AND (True when Argument 1 and Argument 2 are True)
2	XOR (True when Argument 1 is not equal to Argument 2)

**Table 32 – Condition Operator Options**

If only one condition is used, it is important to make sure that Operator 3 (Condition Operator) is set to **OR** so that the result is based solely on the condition which has been chosen.

### 1.12. Set-Reset Latch Function Block

The Set-Reset Latches are disabled by default and must first be enabled through object 3900h **SR Latch Enable** to be configured. The Set-Reset Blocks consist of only 2 control sources: Reset and Set. The purpose of these blocks is to simulate a modified latching function in which the **Reset** signal has more precedence. The latching function works as per the Table below.

Set Signal	Reset Signal	SR Latch Block Output (Initial State: OFF)
OFF	OFF	Latched State
OFF	ON	OFF
ON	OFF	ON
ON	ON	OFF

**Table 33 – Set-Reset Function Block Operation**

The Reset and Set sources have minimum and maximum threshold values associated with them, which determine the ON/OFF state. Reset threshold values are assigned using object 39x3h **SR Latch [x] Reset Minimum Threshold** and object 39x4h **SR Latch [x] Reset Maximum Threshold**. Set threshold values are assigned using object 39x7h **SR Latch [x] Set Minimum Threshold** and 39x8h **SR Latch [x] Set Maximum Threshold**. These values are a configurable percentage ranging from 0% to 100%, corresponding to the selected input range. The threshold values can allow for a dead band in between the ON/OFF states.

The **Reset** signal has more precedence over the **Set** signal. If the state of the Reset signal is **ON**, the state of the SR Block Output will be **OFF** regardless of the Set signal. To create an ON output state, the Reset signal must be OFF while the Set signal is ON. Once set, the output will stay ON even if the Set signal is turned OFF, as long as the Reset signal is also OFF. As soon as the Reset signal turns ON the output will turn OFF, regardless of the state of the Set signal.

### 1.13. Miscellaneous Function Block

There are some other objects available which have not yet been discussed or mentioned briefly in passing (i.e. constants.) These objects are not necessarily associated with one another but are all discussed here.

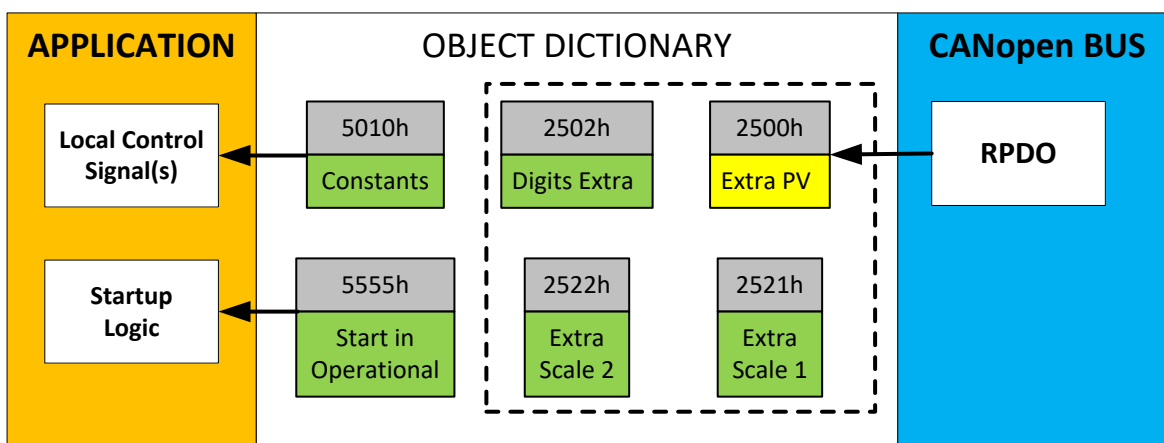

Figure 22 – Miscellaneous Objects

#### Extra RPDO Messages

Objects 2500h **Extra Control Received PV**, 2502h **EC Decimal Digits PV**, 2502h **EC Scaling 1 PV** and **EC Scaling 2 PV** have been mentioned in Section 1.3, Table 16. These objects allow for additional data received on a CANopen® RPDO to be mapped independently to various function blocks as a control source. For example, a PID loop must have two inputs (target and feedback), so one of them has to come from the CAN bus. The scaling objects are provided to define the limits of the data when it is used by another function block, as shown in Table 17.

#### Constant Values

Object 5010h **Constant Field Value** is provided to give the user the option for a fixed value that can be used by other function blocks. Sub-index 1 is fixed as FALSE (0) and sub-index 2 is always TRUE (1). There are 13 other sub-indexes provided for user selectable values.

The constants are read as 32-bit real (float) data, so no decimal digit object is provided. When setting up the constant, make sure to do it with the resolution of the object that will be compared with it.



The False/True constants are provided primarily to be used with the logic block. The variable constants are also useful with the logic or math blocks, and they can also be used as a setpoint target for a PID control block.

### Fault Detection Objects

Object 5040h **FD Field Value** is a read only object containing the field values of the over temperature, over and under voltage. Object 5041h **FD Set Threshold** sets the limit values for which the faults occur when reached. When any of these thresholds are reached, the faults will clear when the values have lowered to values set in object 5042h **FD Clear Threshold**.

For the I/O controller to begin monitoring fault detections, object 5050h **Error Check Detection** determines which Fault Detection is enabled through 1 byte data as bits. Once a fault is detected, object 5051h **Error Response Delay** will determine how long the fault needs to be present to flag and error.

### Automatic Update of Objects

Object 5550h **Enable Automatic Updates** allows for the controller to automatically update the objects related to the output to defaults when it is changed. By default, this object is set to TRUE, in which case the objects are set to their default values depending on the type selected.

On the other hand, when this object is FALSE, the objects are not set to defaults and are left with the same values previous to changing the type. In this case, these are to be configured manually.

### Startup

The last object 5555h **Start in Operational** is provided as a 'cheat' when the unit is not intended to work with a CANopen® network (i.e. a stand-alone control) or is working on a network comprised solely as slaves so the OPERATION command will never be received from a master. By default, this object is disabled (FALSE).

When using the ECU as a stand-alone controller where 5555h is set to TRUE, it is recommended to disable all TPDOs (set the Event Timer to zero) so that it does not run with a continuous CAN error when not connected to a bus.

## 1.14. Dimensions and Pinout

The Ten Output Valve Controller is packaged in a plastic housing from TE Deutsch. The assembly carries an IP67 rating.

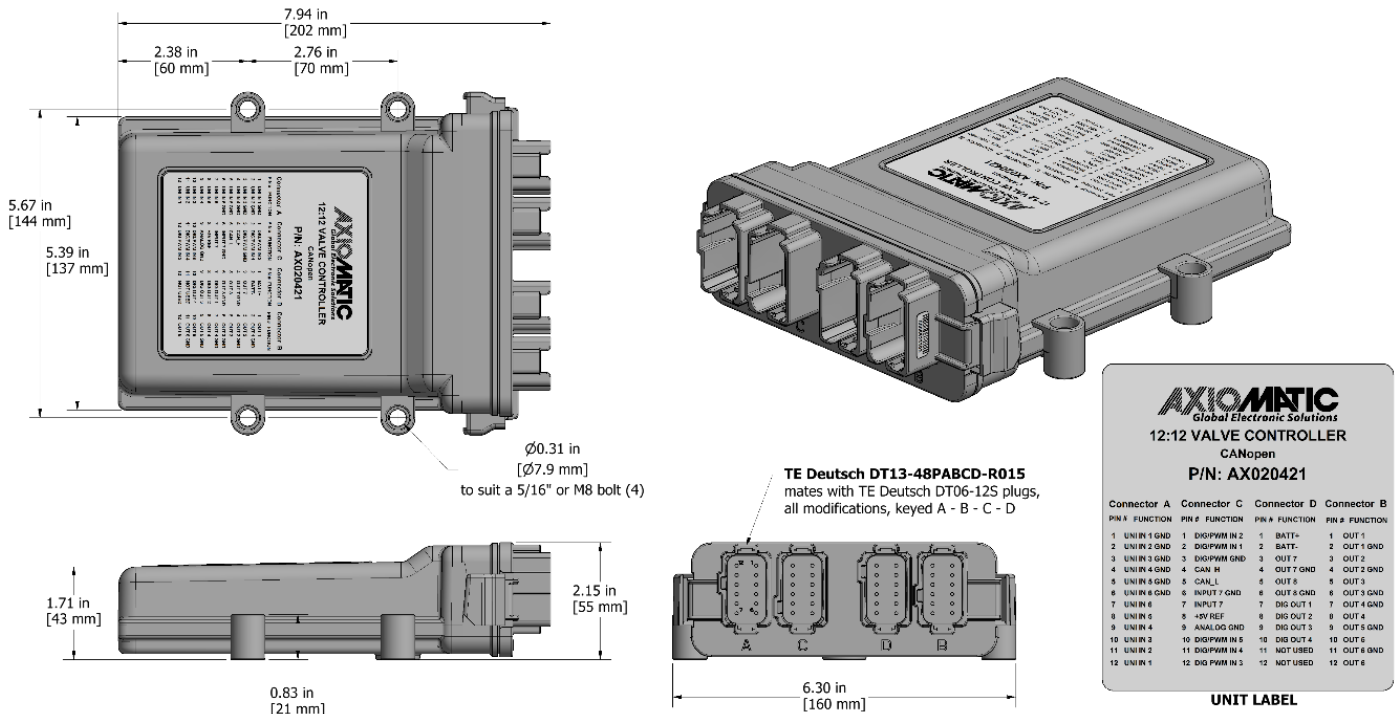
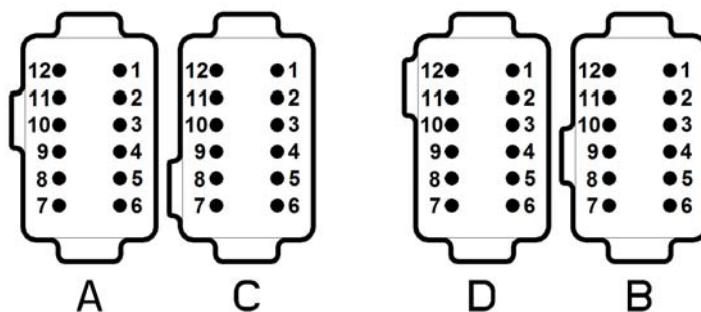

Figure 16 – Housing Dimensions

48-pin TE Deutsch connector (P/N: DT13-48PABCD-R015) or Amphenol face plate connector (P/N: ATM13-12PA-12PB-BM03), based on availability.



Connector A		Connector C	
Pin	Function	Pin	Function
1	Universal Input GND	1	Universal Input 9
2	Universal Input GND	2	Universal Input 8
3	Universal Input GND	3	Universal Input GND
4	Universal Input GND	4	CAN H
5	Universal Input GND	5	CAN L
6	Universal Input GND	6	Universal Input GND
7	Universal Input 6	7	Universal Input 7
8	Universal Input 5	8	+5V Reference
9	Universal Input 4	9	Universal Input GND
10	Universal Input 3	10	Universal Input 12
11	Universal Input 2	11	Universal Input 11
12	Universal Input 1	12	Universal Input 10

Connector D		Connector B	
Pin	Function	Pin	Function
1	BATT +	1	BATT +
2	BATT -	2	BATT -
3	Output 7	3	Output 7
4	Output GND	4	Output GND
5	Output 8	5	Output 8
6	Output GND	6	Output GND
7	Output 9	7	Output 9
8	Output 10	8	Output 10
9	Output 11	9	Output 11
10	Output 12	10	Output 12
11	Not Used	11	Not Used
12	Not Used	12	Not Used

Table 31 – Connector Pinout

## 2. CANOPEN ® OBJECT DICTIONARY

---

The CANopen ® object dictionary of the 12UIN-12OUT Controller is based on CiA device profile DS-404 V1.2 (device profile for Closed Loop Controllers). The object dictionary includes Communication Objects beyond the minimum requirements in the profile, as well as several manufacturer-specific objects for extended functionality.

### 2.1. NODE ID and BAUDRATE

By default, the Controller ships factory programmed with a Node ID = 127 (0x7F) and with Baud rate = 125 kbps.

#### 2.1.1. LSS Protocol to Update

The only means by which the Node-ID and Baud rate can be changed is to use Layer Settling Services (LSS) and protocols as defined by CANopen® standard DS-305.

Follow the steps below to configure either variable using LSS protocol. If required, please refer to the standard for more detailed information about how to use the protocol.

##### 2.1.1.1. Setting Node-ID

- Set the module state to LSS-configuration by **sending** the following message:

<i>Item</i>	<i>Value</i>
COB-ID	0x7E5
Length	2
Data 0	0x04 (cs=4 for switch state global)
Data 1	0x01 (switches to configuration state)

- Set the Node-ID by **sending** the following message:

<i>Item</i>	<i>Value</i>
COB-ID	0x7E5
Length	2
Data 0	0x11 (cs=17 for configure node-id)
Data 1	Node-ID (set new Node-ID as a hexadecimal number)

- The module will send the following response (any other response is a failure).

<i>Item</i>	<i>Value</i>
COB-ID	0x7E4
Length	3
Data 0	0x11 (cs=17 for configure node-id)
Data 1	0x00
Data 2	0x00

- Save the configuration by **sending** the following message:

<i>Item</i>	<i>Value</i>
COB-ID	0x7E5
Length	1
Data 0	0x17 (cs=23 for store configuration)

- The module will send the following response (any other response is a failure):

<i>Item</i>	<i>Value</i>
COB-ID	0x7E4
Length	3
Data 0	0x17 (cs=23 for store configuration)
Data 1	0x00
Data 2	0x00

- Set the module state to LSS-operation by **sending** the following message:  
(Note, the module will reset itself back to the pre-operational state)

<i>Item</i>	<i>Value</i>
COB-ID	0x7E5
Length	2
Data 0	0x04 (cs=4 for switch state global)
Data 1	0x00 (switches to waiting state)

### 2.1.1.2. Setting Baudrate

- Set the module state to LSS-configuration by **sending** the following message:

<i>Item</i>	<i>Value</i>
COB-ID	0x7E5
Length	2
Data 0	0x04 (cs=4 for switch state global)
Data 1	0x01 (switches to configuration state)

- Set the baudrate by **sending** the following message:

<i>Item</i>	<i>Value</i>
COB-ID	0x7E5
Length	3
Data 0	0x13 (cs=19 for configure bit timing parameters)
Data 1	0x00 (switches to waiting state)
Data 2	Index (select baudrate index per Table 32)

<b>Index</b>	<b>Bit Rate</b>
<b>0</b>	1 Mbit/s
<b>1</b>	800 kbit/s
<b>2</b>	500 kbit/s
<b>3</b>	250 kbit/s
<b>4</b>	125 kbit/s (default)
<b>5</b>	reserved (100 kbit/s)
<b>6</b>	50 kbit/s
<b>7</b>	20 kbit/s
<b>8</b>	10 kbit/s

**Table 32 – LSS Baudrate Indices**

- The module will send the following response (any other response is a failure):

<b>Item</b>	<b>Value</b>
COB-ID	0x7E4
Length	3
Data 0	0x13 (cs=19 for configure bit timing parameters)
Data 1	0x00
Data 2	0x00

- Activate bit timing parameters by **sending** the following message:

<b>Item</b>	<b>Value</b>
COB-ID	0x7E5
Length	3
Data 0	0x15 (cs=19 for activate bit timing parameters)
Data 1	<delay_lsb>
Data 2	<delay_msb>

The delay individually defines the duration of the two periods of time to wait until the bit timing parameters switch is done (first period) and before transmitting any CAN message with the new bit timing parameters after performing the switch (second period). The time unit of switch delay is 1 ms.

- Save the configuration by **sending** the following message (on the NEW baudrate):

<b>Item</b>	<b>Value</b>
COB-ID	0x7E5
Length	1
Data 0	0x17 (cs=23 for store configuration)

- The module will send the following response (any other response is a failure):

<b>Item</b>	<b>Value</b>
COB-ID	0x7E4
Length	3
Data 0	0x17 (cs=23 for store configuration)
Data 1	0x00
Data 2	0x00

- Set the module state to LSS-operation by **sending** the following message:  
(Note, the module will reset itself back to the pre-operational state)

Item	Value
COB-ID	0x7E5
Length	2
Data 0	0x04 (cs=4 for switch state global)
Data 1	0x00 (switches to waiting state)

The following screen capture (left) shows the CAN data was sent (7E5h) and received (7E4h) by the tool when the baud rate was changed to 250 kbps using the LSS protocol. The other image (right) shows what was printed on an example debug RS-232 menu while the operation took place.

Between CAN Frame 98 and 99, the baud rate on the CAN Scope tool was changed from 125 to 250 kbps.

**Net0 | CAN USB331 | 250 - CANscope**

File Can Help

Add/Delete ID Area

from to Add > 0x000 <> 0x7FF Net: 0 - CAN\_USB331

< Del Baud rate: 250

IDs decimal  29 >

Fram...	Absolute Time	RelTime	Id	Atr	L	d1	d2	d3	d4
95	11:42:45.248	6110	07E5		2	04	01		
96	11:42:54.468	9219	07E5		3	13	00	03	
97	11:42:54.468	0	07E4		3	13	00	00	
98	11:42:58.687	4218	07E5		3	15	88	13	
99	11:43:16.579	17891	07E5		1	17			
100	11:43:16.907	328	07E4		3	17	00	00	
101	11:43:23.017	6109	07E5		2	04	00		
102	11:43:23.017	0	0750		1	00			

Send ID:   29-Bit  RTR Len:  Data\$:

Fill: 102(10.2%) Bus: ok STARTED

File Edit Setup Control Window Help

===== Main Menu =====

Choose one of the following:

U: View Object Dictionary

D: Default Object Dictionary

T: Toggle RS-232 Stream On/Off

S: Show/Stop Diagnostics

L: Load New Software

M: Main Menu (this)

->Node Id = 80

->Baudrate= 125 [kbps]

CO: PRE-OPERATIONAL

Activating new baud = 250 [kbps]

CO: STOP

Restarting CAN in 5000 [ms]

CO: PRE-OPERATIONAL

Storing ID

Storing Factory Parameters

Storing Baud

Storing Factory Parameters

Storing Communication Parameters

->Node Id = 80

->Baudrate= 250 [kbps]

CO: PRE-OPERATIONAL

## 2.2. COMMUNICATION OBJECTS (DS-301 and DS-404)

The communication objects supported by the 12UIN-12OUT Controller are listed in the following table. A more detailed description of some of the objects is given in the following subchapters. Only those objects that have device-profile specific information are described. For more information on the other objects, refer to the generic CANopen® protocol specification DS-301.

<b>Index (hex)</b>	<b>Object</b>	<b>Object Type</b>	<b>Data Type</b>	<b>Access</b>	<b>PDO Mapping</b>
1000	Device Type	VAR	UNSIGNED32	RO	No
1001	Error Register	VAR	UNSIGNED8	RO	No
1002	Manufacturer Status Register	VAR	UNSIGNED32	RO	No
1003	Pre-Defined Error Field	ARRAY	UNSIGNED32	RO	No
100C	Guard Time	VAR	UNSIGNED16	RW	No
100D	Life Time Factor	VAR	UNSIGNED8	RW	No
1010	Store Parameters	ARRAY	UNSIGNED32	RW	No
1011	Restore Default Parameters	ARRAY	UNSIGNED32	RW	No
1016	Consumer Heartbeat Time	ARRAY	UNSIGNED32	RW	No
1017	Producer Heartbeat Time	VAR	UNSIGNED16	RW	No
1018	Identity Object	RECORD		RO	No
1020	Verify Configuration	ARRAY	UNSIGNED32	RO	No
1029	Error Behaviour	ARRAY	UNSIGNED8	RW	No
1400	RPDO1 Communication Parameter	RECORD		RW	No
1401	RPDO2 Communication Parameter	RECORD		RW	No
1402	RPDO3 Communication Parameter	RECORD		RW	No
1403	RPDO4 Communication Parameter	RECORD		RW	No
1404	RPDO5 Communication Parameter	RECORD		RW	No
1405	RPDO6 Communication Parameter	RECORD		RW	No
1600	RPDO1 Mapping Parameter	RECORD		RO	No
1601	RPDO2 Mapping Parameter	RECORD		RO	No
1602	RPDO3 Mapping Parameter	RECORD		RO	No
1603	RPDO4 Mapping Parameter	RECORD		RO	No
1604	RPDO5 Mapping Parameter	RECORD		RO	No
1605	RPDO6 Mapping Parameter	RECORD		RO	No
1800	TPDO1 Communication Parameter	RECORD		RW	No
1801	TPDO2 Communication Parameter	RECORD		RW	No
1802	TPDO3 Communication Parameter	RECORD		RW	No
1803	TPDO4 Communication Parameter	RECORD		RW	No
1804	TPDO5 Communication Parameter	RECORD		RW	No
1805	TPDO6 Communication Parameter	RECORD		RW	No
1A00	TPDO1 Mapping Parameter	RECORD		RW	No
1A01	TPDO2 Mapping Parameter	RECORD		RW	No
1A02	TPDO3 Mapping Parameter	RECORD		RW	No
1A03	TPDO4 Mapping Parameter	RECORD		RW	No
1A04	TPDO5 Mapping Parameter	RECORD		RW	No
1A05	TPDO6 Mapping Parameter	RECORD		RW	No



### 2.2.1. Object 1000h: Device Type

This object contains information about the device type as per device profile DS-404. The 32-bit parameter is divided into two 16-bit values, showing General and Additional information as shown below.

MSB

LSB

<b>Additional Information = 0xE01C</b>	<b>General Information = 0x0194 (404)</b>
--	---

DS-404 defines the Additional Information field in the following manner:

- 0000h = reserved
- 0001h = digital input block
- 0002h = analog input block
- 0004h = digital output block
- 0008h = analog output block
- 0010h = controller block (aka PID)
- 0020h = alarm block
- 0040h ... 0800h = reserved
- 1000h = reserved
- 2000h = lookup table block (manufacturer-specific)
- 4000h = programmable logic block (manufacturer-specific)
- 8000h = miscellaneous block (manufacturer-specific)

#### ***Object Description***

Index	1000h
Name	Device Type
Object Type	VAR
Data Type	UNSIGNED32

#### ***Entry Description***

Access	RO
PDO Mapping	No
Value Range	0xE01F0194
Default Value	0xE01F0194

### 2.2.2. Object 1001h: Error Register

This object is an error register for the device. Any time there is an error detected by the Controller, the Generic Error Bit (bit 0) is set. Only if there are no errors in the module this bit will be cleared. No other bits in this register are used by the Controller.

#### ***Object Description***

Index	1001h
Name	Error Register
Object Type	VAR
Data Type	UNSIGNED8

### ***Entry Description***

Access	RO
PDO Mapping	No
Value Range	00h or 01h
Default Value	0

### **2.2.3. Object 1002h: Manufacturer Status Register**

This object is used for manufacturer debug purposes.

### **2.2.4. Object 1003h: Pre-Defined Error Field**

This object provides an error history by listing the errors in the order that they have occurred. An error is added to the top of the list when it occurs and is immediately removed when the error condition has been cleared. The latest error is always at sub-index 1, with sub-index 0 containing the number of errors currently in the list. When the device is in an error-free state, the value of sub-index 0 is zero.

The error list may be cleared by writing a zero to sub-index 0, which will clear all errors from the list, regardless of whether or not they are still present. Clearing the list does NOT mean that the module will return to the error-free behaviour state if at least one error is still active.

The Controller has a limitation of a maximum of 4 errors in the list. If the device registers more errors, the list will be truncated, and the oldest entries will be lost.

The error codes stored in the list are 32-bit unsigned numbers, consisting of two 16-bit fields. The lower 16-bit field is the EMCY error code, and the higher 16-bit field is a manufacturer-specific code. The manufacturer-specific code is divided into two 8-bit fields, with the higher byte indicating the error description, and the lower byte indicating the channel on which the error occurred.

MSB

LSB

<b>Error Description</b>	<b>Channel-ID</b>	<b>EMCY Error Code</b>
--------------------------	-------------------	------------------------

If node-guarding is used (not recommended per the latest standard) and a lifeguard event occurs, the manufacturer-specific field will be set to 0x1000. On the other hand, if a heartbeat consumer fails to be received within the expected timeframe, the Error Description will be set to 0x80, and the Channel-ID (nn) will reflect the Node-ID of the consumer channel that was not producing. In this case, the manufacturer-specific field will therefore be 0x80nn. In both cases, the corresponding EMCY Error Code will be the Guard Error 0x8130.

If the controller detects a Bus OFF event, the controller will continuously attempt to reconnect to the CAN bus. Once reconnected, the emcy message for a Bus OFF Recovery event will be sent over the network, after which the error will be cleared. The emcy message will be sent and then cleared every time the controller recovers from a Bus OFF event.

When an analog output is not working as described in Section 1.5, then the Error Description will reflect what channel(s) is at fault using the following table. Also, if an RPDO is not received within the expected "Event Timer" period, an RPDO timeout will be flagged. Table 33 outlines the resulting Error Field Codes and their meanings.

Error Field Code	Error Description	Meaning	ID	Meaning	EMCY Code	Meaning
0000000h	EMCY Error Reset (fault no longer active)					
400yF001h	40h	Positive Overload (Out-of-range High)	0yh	Universal Input y	F001h	Input Overload
500yF001h	50h	Negative Overload (Out-of-range Low)	0yh	Universal Input y	F001h	Input Overload
100yF002h	10h	Sensor Break (Open Circuit on AO)	0yh	Proportional Output y	F002h	Output Overload
000y2310h	00h	Short Circuit on AO	0yh	Proportional Output y	2310h	Current at Output too High (short to GND or Vcc)
40003100h	40h	Positive Overload (Vps Overvoltage)	00h	Unspecified	3100h	Device Voltage
50003100h	50h	Negative Overload (Vps Undervoltage)	00h	Unspecified	3100h	Device Voltage
40004200h	40h	Positive Overload (Over Temp)	00h	Unspecified	4200h	Device Temperature
00008100h	00h	RPDO Timeout	00h	Unspecified	8100h	Communication - generic
10008130h	10h	Lifeguard Event	00h	Unspecified	8130h	Lifeguard/Heartbeat Error
80nn8130h	80h	Heartbeat Timeout	nn	Node-ID	8130h	Lifeguard/Heartbeat Error
00008140h	00h	Bus OFF Event	00h	Unspecified	8400h	Bus OFF Recovery

**Table 33 – Pre-Defined Error Field Codes**

**Object Description**

Index	1003h
Name	Pre-Defined Error Field
Object Type	ARRAY
Data Type	UNSIGNED32

**Entry Description**

Sub-Index	0h
Description	Number of entries
Access	RW
PDO Mapping	No
Value Range	0 to 15
Default Value	0

Sub-Index	1h to 15
Description	Standard error field
Access	RO
PDO Mapping	No
Value Range	UNSIGNED32
Default Value	0

**2.2.5. Object 100Ch: Guard Time**

The objects at index 100Ch and 100Dh shall indicate the configured guard time respective to the life time factor. The life time factor multiplied with the guard time gives the life time for the life guarding protocol described in DS-301. The Guard Time value shall be given in multiples of ms, and a value of 0000h shall disable the life guarding.

It should be noted that this object, and that of 100Dh are only supported for backwards compatibility. The standard recommends that newer networks do not use the life guarding protocol, but rather heartbeat monitoring instead. Both life guarding and heartbeats can NOT be active simultaneously.

**Object Description**

Index	100Ch
Name	Guard Time
Object Type	VAR
Data Type	UNSIGNED16

**Entry Description**

Sub-Index	0h
Access	RW
PDO Mapping	No
Value Range	0 to 65535
Default Value	0

**2.2.6. Object 100Dh: Lifetime Factor**

The life time factor multiplied with the guard time gives the life time for the life guarding protocol. A value of 00h shall disable life guarding.

**Object Description**

Index	100Dh
Name	Life time factor
Object Type	VAR
Data Type	UNSIGNED8

**Entry Description**

Sub-Index	0h
Access	RW
PDO Mapping	No
Value Range	0 to 255
Default Value	0

**2.2.7. Object 1010h: Store Parameters**

This object supports the saving of parameters in non-volatile memory. In order to avoid storage of parameters by mistake, storage is only executed when a specific signature is written to the appropriate sub-index. The signature is “save”.

The signature is a 32-bit unsigned number, composed of the ASCII codes of the signature characters, according to the following table:

MSB		LSB	
e	v	a	s
65h	76h	61h	73h

On reception of the correct signature to an appropriate sub-index, the Controller will store the parameters in non-volatile memory, and then confirm the SDO transmission.

By read access, the object provides information about the module's saving capabilities. For all sub-indexes, this value is 1h, indicating that the Controller saves parameters on command. **This means that if power is removed before the Store object is written, changes to the Object Dictionary will NOT have been saved in the non-volatile memory and will be lost on the next power cycle.**

### ***Object Description***

Index	1010h
Name	Store Parameters
Object Type	ARRAY
Data Type	UNSIGNED32

### ***Entry Description***

Sub-Index	0h
Description	Largest sub-index supported
Access	RO
PDO Mapping	No
Value Range	8
Default Value	8

Sub-Index	1h
Description	Save all parameters
Access	RW
PDO Mapping	No
Value Range	0x65766173 (write access) 1h (read access)
Default Value	1h

Sub-Index	2h
Description	Save communication parameters
Access	RW
PDO Mapping	No
Value Range	0x65766173 (write access) 1h (read access)
Default Value	1h

Sub-Index	3h
Description	Save application parameters
Access	RW
PDO Mapping	No
Value Range	0x65766173 (write access) 1h (read access)
Default Value	1h

Sub-Index	4h
Description	Save manufacturer parameters
Access	RW
PDO Mapping	No
Value Range	0x65766173 (write access) 1h (read access)
Default Value	1h

### 2.2.8. Object 1011h: Restore Parameters

This object supports the restoring of the default values for the object dictionary in non-volatile memory. In order to avoid restoring of parameters by mistake, the device restores the defaults only when a specific signature is written to the appropriate sub-index. The signature is “load”.

The signature is a 32-bit unsigned number, composed of the ASCII codes of the signature characters, according to the following table:

MSB		LSB	
d	a	o	l
64h	61h	6Fh	6Ch

On reception of the correct signature to an appropriate sub-index, the Controller will restore the defaults in non-volatile memory, and then confirm the SDO transmission. **The default values are set valid only after the device is reset or power-cycled.** This means that the Controller will NOT start using the default values right away, but rather continue to run from whatever values were in the Object Dictionary prior to the restore operation.

By read access, the object provides information about the module’s default parameter restoring capabilities. For all sub-indexes, this value is 1h, indicating that the Controller restores defaults on command.

#### **Object Description**

Index	1011h
Name	Restore Default Parameters
Object Type	ARRAY
Data Type	UNSIGNED32

#### **Entry Description**

Sub-Index	0h
Description	Largest sub-index supported
Access	RO
PDO Mapping	No
Value Range	4
Default Value	4

Sub-Index	1h
Description	Restore all default parameters
Access	RW
PDO Mapping	No
Value Range	0x64616F6C (write access), 1h (read access)

Default Value	1h
Sub-Index	2h
Description	Restore default communication parameters
Access	RW
PDO Mapping	No
Value Range	0x64616F6C (write access), 1h (read access)
Default Value	1h

Sub-Index	3h
Description	Restore default application parameters
Access	RW
PDO Mapping	No
Value Range	0x64616F6C (write access), 1h (read access)
Default Value	1h

Sub-Index	4h
Description	Restore default manufacturer parameters
Access	RW
PDO Mapping	No
Value Range	0x64616F6C (write access), 1h (read access)
Default Value	1h

### 2.2.9. Object 1016h: Consumer Heartbeat Time

The Controller can be a consumer of heartbeat objects for a single module. This object defines the expected heartbeat cycle time for that module, and if set to zero, it is not used. When the object is non-zero, the time is a multiple of 1ms, and monitoring will start after the reception of the first heartbeat from the module. If the Controller fails to receive a heartbeat from a node in the expected timeframe, it will indicate a communication error and respond as per object 1029h.

Bits	31-24	23-16	15-0
Value	Reserved 00h	Node-ID	Heartbeat time
Encoded as		UNSIGNED8	UNSIGNED16

#### ***Object Description***

Index	1016h
Name	Consumer heartbeat time
Object Type	ARRAY
Data Type	UNSIGNED32

#### ***Entry Description***

Sub-Index	0h
Description	Number of entries
Access	RO
PDO Mapping	No
Value Range	1
Default Value	1

Sub-Index	1h
Description	Consumer heartbeat time
Access	RW
PDO Mapping	No
Value Range	UNSIGNED32
Default Value	0

### 2.2.10. Object 1017h: Producer Heartbeat Time

The Controller could be configured to produce a cyclical heartbeat by writing a non-zero value to this object. The value will be given in multiples of 1ms, and a value of 0 shall disable the heartbeat.

#### **Object Description**

Index	1017h
Name	Producer heartbeat time
Object Type	VAR
Data Type	UNSIGNED16

#### **Entry Description**

Sub-Index	0h
Access	RW
PDO Mapping	No
Value Range	10 to 65535
Default Value	0

### 2.2.11. Object 1018h: Identity Object

The identity object indicates the data of the Controller, including vendor id, device id, software and hardware version numbers, and the serial number.

In the Revision Number entry at sub-index 3, the format of the data is as shown below

MSB	LSB
Major revision number (object dictionary)	Hardware Revision      Software Version

#### **Object Description**

Index	1018h
Name	Identity Object
Object Type	RECORD
Data Type	Identity Record

#### **Entry Description**

Sub-Index	0h
Description	Number of entries
Access	RO
PDO Mapping	No
Value Range	4
Default Value	4



Sub-Index	1h
Description	Vendor ID
Access	RO
PDO Mapping	No
Value Range	0x00000055
Default Value	0x00000055 (Axiomatic)

Sub-Index	2h
Description	Product Code
Access	RO
PDO Mapping	No
Value Range	0xAA020421
Default Value	0xAA020421

Sub-Index	3h
Description	Revision Number
Access	RO
PDO Mapping	No
Value Range	UNSIGNED32
Default Value	No

Sub-Index	4h
Description	Serial Number
Access	RO
PDO Mapping	No
Value Range	UNSIGNED32
Default Value	No

### 2.2.12. Object 1020h: Verify Configuration

This object can be read to see what date the software (version identified in object 1018h) was compiled. The date is represented as a hexadecimal value showing day/month/year as per the format below. The time value at sub-index 2 is a hexadecimal value showing the time in a 24 hour clock

MSB	LSB	
Day (in 1-Byte Hex)	Month (in 1-Byte Hex)	Year (in 2-Byte Hex)
00	00	Time (in 2-Byte Hex)

For example, a value of 0x30042014 would indicate that the software was compiled on April 30<sup>th</sup>, 2014. A time value of 0x00001842 would indicate it was compiled at 6:42pm.

#### ***Object Description***

Index	1020h
Name	Verify configuration
Object Type	ARRAY
Data Type	UNSIGNED32

### ***Entry Description***

Sub-Index	0h
Description	Number of entries
Access	RO
PDO Mapping	No
Value Range	2
Default Value	2

Sub-Index	1h
Description	Configuration date
Access	RO
PDO Mapping	No
Value Range	UNSIGNED32
Default Value	No

Sub-Index	2h
Description	Configuration time
Access	RO
PDO Mapping	No
Value Range	UNSIGNED32
Default Value	No

### **2.2.13. Object 1029h: Error Behaviour**

This object controls the state that the Controller will be set into in case of an error of the type associated with the sub-index.

**Note: Object 1029h Error Behaviour can ONLY be changed if there are NO errors present (1001h = 1). Ensure errors are cleared or disabled to change this object.**

A network fault is flagged when an RPDO is not received within the expected time period defined in the “Event Timer” of the associated communication objects, (see Section 2.2.14 for more information) or if a lifeguard or heartbeat message is not received as expected. Input faults are defined in Section 1.3, and output faults are defined in Section 1.5. Power Supply faults are described in Section 1.10.

For all sub-indexes, the following definitions hold true:

- 0 = Pre-Operational (node reverts to a pre-operational state when this fault is detected)
- 1 = No State Change (node remains in the same state it was in when the fault occurred)
- 2 = Stopped (node goes into stopped mode when the fault occurs)

### ***Object Description***

Index	1029h
Name	Error Behaviour
Object Type	ARRAY
Data Type	UNSIGNED8

**Entry Description**

Sub-Index	0h
Description	Number of entries
Access	RO
PDO Mapping	No
Value Range	6
Default Value	6

Sub-Index	1h
Description	Communication Fault
Access	RW
PDO Mapping	No
Value Range	See above
Default Value	0 (Pre-Operational)

Sub-Index	2h
Description	Digital Input Error
Access	RW
PDO Mapping	No
Value Range	See above
Default Value	1 (No State Change)

Sub-Index	3h
Description	Analog Input Error
Access	RW
PDO Mapping	No
Value Range	See above
Default Value	1 (No State Change)

Sub-Index	4h
Description	Digital Output Error
Access	RW
PDO Mapping	No
Value Range	See above
Default Value	1 (No State Change)

Sub-Index	5h
Description	Analog Output Error
Access	RW
PDO Mapping	No
Value Range	See above
Default Value	1 (No State Change)

Sub-Index	6h
Description	Fault Detection Error
Access	RW
PDO Mapping	No
Value Range	See above
Default Value	1 (No State Change)

## 2.2.14. RPDO Behaviour

Per the CANopen® standard DS-301, the following procedure shall be used for re-mapping and is the same for both RPDOs and TPDOs.

- Destroy the PDO by setting bit **exists** (most significant bit) of sub-index 01h of the according PDO communication parameter to 1b
- Disable mapping by setting sub-index 00h of the corresponding mapping object to 0
- Modify the mapping by changing the values of the corresponding sub-indices
- Enable mapping by setting sub-index 00h to the number of mapped objects
- Create the PDO by setting bit **exists** (most significant bit) of sub-index 01h of the according PDO communication parameter to 0b

The Controller can support up to six RPDO messages. All RPDOs on the Controller use the similar default communication parameters, with the PDO IDs set according to the pre-defined connection set described in DS-301. Most RPDOs do not exist, there is no RTR allowed, they use 11-bit CAN-IDs (base frame valid), and they are all event-driven. While all six have valid default mappings defined (see below) only RPDO1 is enabled by default (i.e. RPDO exists).

### ***RPDO1 Mapping at Object 1600h: Default ID 0x200 + Node ID***

<b>Sub-Index</b>	<b>Value</b>	<b>Object</b>
0	4	Number of mapped application objects in PDO
1	0x73000110	Proportional Output 1 Process Value
2	0x73000210	Proportional Output 2 Process Value
3	0x73000310	Proportional Output 3 Process Value
4	0x73000410	Proportional Output 4 Process Value

### ***RPDO2 Mapping at Object 1601h: Default ID 0x300 + Node ID***

<b>Sub-Index</b>	<b>Value</b>	<b>Object</b>
0	4	Number of mapped application objects in PDO
1	0x73000510	Proportional Output 5 Process Value
2	0x73000610	Proportional Output 6 Process Value
3	0x73000710	Proportional Output 7 Process Value
4	0x73000810	Proportional Output 8 Process Value

### ***RPDO3 Mapping at Object 1602h: Default ID 0x400 + Node ID***

<b>Sub-Index</b>	<b>Value</b>	<b>Object</b>
0	4	Number of mapped application objects in PDO
1	0x73000910	Proportional Output 9 Process Value
2	0x73000A10	Proportional Output 10 Process Value
3	0x73000B10	Proportional Output 11 Process Value
4	0x73000C10	Proportional Output 12 Process Value

### ***RPDO4 Mapping at Object 1603h: Default ID 0x500 + Node ID***

<b>Sub-Index</b>	<b>Value</b>	<b>Object</b>
0	4	Number of mapped application objects in PDO
1	0x25000110	Extra Received 1 PV
2	0x25000210	Extra Received 2 PV
3	0x25000310	Extra Received 3 PV
4	0x25000410	Extra Received 4 PV

**RPDO5 Mapping at Object 1604h: Default ID 0x201**

<b>Sub-Index</b>	<b>Value</b>	<b>Object</b>
0	4	Number of mapped application objects in PDO
1	0x25000510	Extra Received 5 PV
2	0x25000610	Extra Received 6 PV
3	0x25000710	Extra Received 7 PV
4	0x25000810	Extra Received 8 PV

**RPDO6 Mapping at Object 1605h: Default ID 0x301**

<b>Sub-Index</b>	<b>Value</b>	<b>Object</b>
0	4	Number of mapped application objects in PDO
1	0x25000910	Extra Received 9 PV
2	0x25000A10	Extra Received 10 PV
3	0	
4	0	

None of them have the timeout feature enabled, i.e. the “Event Timer” on sub-index 5 is set to zero. When this is changed to a non-zero value, if the RPDO has not been received from another node within the time period defined (while in Operational mode), a network fault is activated, and the controller will go to the operational state define in Object 1029h sub-index 4.

**Object Description**

Index	1400h to 1405h
Name	RPDO communication parameter
Object Type	RECORD
Data Type	PDO Communication Record

**Entry Description**

Sub-Index	0h
Description	Number of entries
Access	RO
PDO Mapping	No
Value Range	5
Default Value	5

Sub-Index	1h
Description	COB-ID used by RPDO
Access	RW
PDO Mapping	No
Value Range	See value definition in DS-301
Default Value	40000000h + RPDO1 + Node ID C0000000h + RPDOx + Node-ID

<b>X</b>	<b>RPDOx ID</b>
1	0200h
2	0300h
3	0400h
4	0500h
5	0201h
6	0301h

Node-ID = Node-ID of the module. The RPDO COB-IDs are automatically updated if the Node-ID is changed by LSS protocol.

80000000h in the COB-ID indicates that the PDO does not exist (destroyed)

04000000h in the COB-ID indicates that there is no RTR allowed on the PDO

Sub-Index	2h
Description	Transmission type
Access	RO
PDO Mapping	No
Value Range	See value definition in DS-301
Default Value	255 (FFh) = Event Driven

Sub-Index	3h
Description	Inhibit Time
Access	RW
PDO Mapping	No
Value Range	See value definition in DS-301
Default Value	0

Sub-Index	4h
Description	Compatibility entry
Access	RW
PDO Mapping	No
Value Range	UNSIGNED8
Default Value	0

Sub-Index	5
Description	Event-timer
Access	RW
PDO Mapping	No
Value Range	See value definition in DS-301
Default Value	0

*Recall: A non-zero event timer for an RPDO means that it will result in a network fault being flagged if it has not been received within this timeframe while in Operational mode.*

### 2.2.15. TPDO Behaviour

The Controller can support up to eight TPDO messages. All TPDOs on the Controller use the similar default communication parameters, with the PDO IDs set according to the pre-defined connection set described in DS-301. Most TPDOs do not exist, there is no RTR allowed, they use 11-bit CAN-IDs (base frame valid), and they are all time-driven. While all have valid default mappings defined (see below) only TPDO1 to TPDO3 are enabled by default (i.e. TPDO exists).

#### ***TPDO1 Mapping at Object 1A00h: Default ID 0x180 + Node ID***

<b>Sub-Index</b>	<b>Value</b>	<b>Object</b>
0	4	Number of mapped application objects in PDO
1	0x71000110	Universal Input 1 Field Value
2	0x71000210	Universal Input 2 Field Value
3	0x71000310	Universal Input 3 Field Value
4	0x71000410	Universal Input 4 Field Value

**TPDO2 Mapping at Object 1A01h: Default ID 0x280 + Node ID**

<b>Sub-Index</b>	<b>Value</b>	<b>Object</b>
0	4	Number of mapped application objects in PDO
1	0x71000510	Universal Input 5 Field Value
2	0x71000610	Universal Input 6 Field Value
3	0x71000710	Universal Input 7 Field Value
4	0x71000810	Universal Input 8 Field Value

**TPDO3 Mapping at Object 1A02h: Default ID 0x380 + Node ID**

<b>Sub-Index</b>	<b>Value</b>	<b>Object</b>
0	1	Number of mapped application objects in PDO
1	0x71000910	Universal Input 9 Field Value
2	0x71000A10	Universal Input 10 Field Value
3	0x71000B10	Universal Input 11 Field Value
4	0x71000C10	Universal Input 12 Field Value

**TPDO4 Mapping at Object 1A03h: Default ID 0x480 + Node ID**

<b>Sub-Index</b>	<b>Value</b>	<b>Object</b>
0	2	Number of mapped application objects in PDO
1	0x23700110	Proportional Output 1 Feedback Field Value
2	0x23700210	Proportional Output 2 Feedback Field Value
3	0x23700310	Proportional Output 3 Feedback Field Value
4	0x23700410	Proportional Output 4 Feedback Field Value

**TPDO5 Mapping at Object 1A04h: Default ID 0x181**

<b>Sub-Index</b>	<b>Value</b>	<b>Object</b>
0	1	Number of mapped application objects in PDO
1	0x23700510	Proportional Output 5 Feedback Field Value
2	0x23700610	Proportional Output 6 Feedback Field Value
3	0x23700710	Proportional Output 7 Feedback Field Value
4	0x23700810	Proportional Output 8 Feedback Field Value

**TPDO6 Mapping at Object 1A05h: Default ID 0x281**

<b>Sub-Index</b>	<b>Value</b>	<b>Object</b>
0	2	Number of mapped application objects in PDO
1	0x23700910	Proportional Output 9 Feedback Field Value
2	0x23700A10	Proportional Output 10 Feedback Field Value
3	0x23700B10	Proportional Output 11 Feedback Field Value
4	0x23700C10	Proportional Output 12 Feedback Field Value

**TPDO7 Mapping at Object 1A06h: Default ID 0x381**

<b>Sub-Index</b>	<b>Value</b>	<b>Object</b>
0	2	Number of mapped application objects in PDO
1	0x50400110	Processor Temperature Measured
2	0x50400210	Power Supply Measured
3		
4		

Since only TPDO1 to TPDO3 have a non-zero value transmission rate (i.e. Event Timer in sub-index 5 of communication object), only these TPDOs will be automatically broadcasted when the unit goes into OPERATIONAL mode.

### **Object Description**

Index	1800h to 1806h
Name	TPDO communication parameter
Object Type	RECORD
Data Type	PDO Communication Record

### **Entry Description**

Sub-Index	0h
Description	Number of entries
Access	RO
PDO Mapping	No
Value Range	5
Default Value	5

Sub-Index	1h
Description	COB-ID used by TPDO
Access	RW
PDO Mapping	No
Value Range	See value definition in DS-301
Default Value	40000000h + TPDOx + Node-ID C0000000h + TPDOy + Node-ID

X	TPDOx ID	Y	TPDOy ID
1	0180h	5	0181h
2	0280h	6	0281h
3	0380h	7	0381h
4	0480h	8	0481h

Node-ID = Node-ID of the module. The TPDO COB-IDs are automatically updated if the Node-ID is changed by LSS protocol.

80000000h in the COB-ID indicates that the PDO does not exist (destroyed)

04000000h in the COB-ID indicates that there is no RTR allowed on the PDO

Sub-Index	2h
Description	Transmission type
Access	RO
PDO Mapping	No
Value Range	See value definition in DS-301
Default Value	254 (FEh) = Event Driven

Sub-Index	3h
Description	Inhibit Time
Access	RW
PDO Mapping	No
Value Range	See value definition in DS-301
Default Value	0

Sub-Index	4h
Description	Compatibility entry
Access	RW
PDO Mapping	No
Value Range	UNSIGNED8
Default Value	0



Sub-Index	5
Description	Event-timer
Access	RW
PDO Mapping	No
Value Range	See value definition in DS-301
Default Value	250ms (on TPDO1,TPDO2, TPDO3) 0ms (on TPDO4 to TPDO8)

### 2.3. APPLICATION OBJECTS (DS-404)

<b>Index (hex)</b>	<b>Object</b>	<b>Object Type</b>	<b>Data Type</b>	<b>Access</b>	<b>PDO Mapping</b>
6000	DI Read State 8 Input Lines	ARRAY	BOOLEAN	RO	Yes
6002	DI Polarity 8 Input Lines	ARRAY	UNSIGNED8	RW	No
7100	AI Input Field Value	ARRAY	INTEGER16	RO	Yes
6110	AI Sensor Type	ARRAY	UNSIGNED16	RW	No
6112	AI Operating Mode	ARRAY	UNSIGNED8	RW	No
7120	AI Input Scaling 1 FV	ARRAY	INTEGER16	RW	No
7121	AI Input Scaling 1 PV	ARRAY	INTEGER16	RW	No
7122	AI Input Scaling 2 FV	ARRAY	INTEGER16	RW	No
7123	AI Input Scaling 2 PV	ARRAY	INTEGER16	RW	No
7130	AI Input Process Value	ARRAY	INTEGER16	RO	Yes
6132	AI Decimal Digits PV	ARRAY	UNSIGNED8	RW	No
7148	AI Input Span Start	ARRAY	INTEGER16	RW	No
7149	AI Input Span End	ARRAY	INTEGER16	RW	No
61A0	AI Filter Type	ARRAY	UNSIGNED8	RW	No
61A1	AI Filter Constant	ARRAY	UNSIGNED16	RW	No
6200	DO Write state 8 Output lines	ARRAY	BOOLEAN	RW	Yes
6202	DO Polarity 8 Output Lines	ARRAY	UNSIGNED8	RW	No
6206	DO Fault Mode 8 Output Lines	ARRAY	UNSIGNED8	RW	No
6207	DO Fault State 8 Output Lines	ARRAY	BOOLEAN	RW	No
7300	AO Output Process Value	ARRAY	INTEGER16	RW	Yes
6302	AO Decimal Digits PV	ARRAY	UNSIGNED8	RW	No
6310	AO Output Type	ARRAY	UNSIGNED16	RW	No
7320	AO Output Scaling 1 PV	ARRAY	INTEGER16	RW	No
7321	AO Output Scaling 1 FV	ARRAY	INTEGER16	RW	No
7322	AO Output Scaling 2 PV	ARRAY	INTEGER16	RW	No
7323	AO Output Scaling 2 FV	ARRAY	INTEGER16	RW	No
7330	AO Output Field Value	ARRAY	INTEGER16	RO	Yes
6332	AO Decimal Digits FV	ARRAY	UNSIGNED8	RW	No
6340	AO Fault Mode	ARRAY	UNSIGNED8	RW	No
7341	AO Fault Field Value	ARRAY	INTEGER16	RW	No
7450	PID Proportional Band	ARRAY	INTEGER16	RW	No
7452	PID Integral Action Time	ARRAY	INTEGER16	RW	No
7454	PID Derivative Action Time	ARRAY	INTEGER16	RW	No
7456	PID Cycle Time	ARRAY	INTEGER16	RW	No
6458	PID Physical Unit Timing	ARRAY	UNSIGNED32	RO	No
6459	PID Decimal Digits Timing	ARRAY	UNSIGNED8	RW	No

### 2.3.1. Object 6000h: DI Read State 8 Input Lines

This read-only object shall read group of 8 input lines as 8-bit information. Refer to Section 1.2 for more information

#### **Object Description**

Index	6000h
Name	DI Read State 8 Input Line
Object Type	ARRAY
Data Type	BOOLEAN

#### **Entry Description**

Sub-Index	0h
Description	Largest sub-index supported
Access	RO
PDO Mapping	No
Value Range	2
Default Value	2

Sub-Index	1h
Description	Digital Input State Bitmap D1-D8
Access	RO
PDO Mapping	Yes
Value Range	0 (OFF) or 1 (ON)
Default Value	0

Sub-Index	2h
Description	Digital Input State Bitmap D9-D12
Access	RO
PDO Mapping	Yes
Value Range	0 (OFF) or 1 (ON)
Default Value	0

### 2.3.2. Object 6002h: DI Polarity 8 Input Lines

This object shall define the polarity of a group of 8 input lines. This object determines how the state read on the input pin corresponds to the logic state, in conjunction with manufacturer object 2020h, as defined in Table 3.

#### **Object Description**

Index	6002h
Name	DI Polarity 1 Input Line
Object Type	ARRAY
Data Type	UNSIGNED8

#### **Entry Description**

Sub-Index	0h
Description	Largest sub-index supported
Access	RO
PDO Mapping	No
Value Range	2
Default Value	2

Sub-Index	1h
Description	Digital Input Polarity Bitmap D1-D8
Access	RW
Section PDO Mapping	No
Value Range	See Table 3
Default Value	0 (Normal On/Off)

Sub-Index	2h
Description	Digital Input Polarity Bitmap D9-D12
Access	RW
PDO Mapping	No
Value Range	See Table 3
Default Value	0 (Normal On/Off)

### 2.3.3. Object 7100h: AI Input Field Value

This object represents the measured value of an analog input that has been scaled as per manufacturer object 2102h AI Decimal Digits PV. The base unit for each type of input is defined in Table 9, as well as the read-only resolution (decimal digits) associated with the FV.

#### ***Object Description***

Index	7100h
Name	AI Input Field Value
Object Type	ARRAY
Data Type	INTEGER16

#### ***Entry Description***

Sub-Index	0h
Description	Largest sub-index supported
Access	RO
PDO Mapping	No
Value Range	12
Default Value	12

Sub-Index	1h to Ch (x = 1 to 12)
Description	Analog Input X FV
Access	RO
PDO Mapping	Yes
Value Range	Data Type Specific, see Table 11
Default Value	No

### 2.3.4. Object 6110h: AI Sensor Type

This object defines the type of sensor (input) which is connected to the analog input pin.

#### ***Object Description***

Index	6110h
Name	AI Sensor Type
Object Type	ARRAY
Data Type	UNSIGNED16

**Entry Description**

Sub-Index	0h
Description	Largest sub-index supported
Access	RO
PDO Mapping	No
Value Range	12
Default Value	12

Sub-Index	1h to Ch (x = 1 to 12)
Description	AIx Sensor Type
Access	RW
PDO Mapping	No
Value Range	See Table 5
Default Value	40 (voltage)

**2.3.5. Object 6112h: AI Operating Mode**

This object enables special operating modes for the input.

**Object Description**

Index	6112h
Name	AI Operating Mode
Object Type	ARRAY
Data Type	UNSIGNED8

**Entry Description**

Sub-Index	0h
Description	Largest sub-index supported
Access	RO
PDO Mapping	No
Value Range	12
Default Value	12

Sub-Index	1h to Ch (x = 1 to 12)
Description	AIx Operating Mode
Access	RW
PDO Mapping	No
Value Range	See Table 4
Default Value	1 (normal operation)

### 2.3.6. Object 7120h: AI Input Scaling 1 FV

This object describes the field value of the first calibration point for the analog input channel, as shown in Figure 7. It also defines the “minimum” value of the analog input range when using this input as a control source for another function block, as described in Table 17 in Section 1.5. It is scaled in the physical unit of the FV, i.e. object 2102h applies to this object.

#### **Object Description**

Index	7120h
Name	AI Input Scaling 1 FV
Object Type	ARRAY
Data Type	INTEGER16

#### **Entry Description**

Sub-Index	0h
Description	Largest sub-index supported
Access	RO
PDO Mapping	No
Value Range	12
Default Value	12
Sub-Index	1h to Ch (x = 1 to 12)
Description	AIx Scaling 1 FV
Access	RW
PDO Mapping	No
Value Range	See Table 11
Default Value	500 [mV]

### 2.3.7. Object 7121h: AI Input Scaling 1 PV

This object defines the process value of the first calibration point for the analog input channel, as shown in Figure 7. It is scaled in the physical unit of the PV, i.e. object 6132h applies to this object.

#### **Object Description**

Index	7121h
Name	AI Input Scaling 1 PV
Object Type	ARRAY
Data Type	INTEGER16

#### **Entry Description**

Sub-Index	0h
Description	Largest sub-index supported
Access	RO
PDO Mapping	No
Value Range	12
Default Value	12

Sub-Index	1h to Ch (x = 1 to 12)
Description	AIx Scaling 1 PV
Access	RW
PDO Mapping	No
Value Range	Integer16
Default Value	500 [same as 7120h]

### 2.3.8. Object 7122h: AI Input Scaling 2 FV

This object describes the field value of the second calibration point for the analog input channel, as shown in Figure 7. It also defines the “maximum” value of the analog input range when using this input as a control source for another function block, as described in Table 17 in Section 1.5. It is scaled in the physical unit of the FV, i.e. object 2102h applies to this object.

#### **Object Description**

Index	7122h
Name	AI Input Scaling 2 FV
Object Type	ARRAY
Data Type	INTEGER16

#### **Entry Description**

Sub-Index	0h
Description	Largest sub-index supported
Access	RO
PDO Mapping	No
Value Range	12
Default Value	12
Sub-Index	1h to Ch (x = 1 to 12)
Description	AIx Scaling 2 FV
Access	RW
PDO Mapping	No
Value Range	See Table 11
Default Value	4500 [mV]

### 2.3.9. Object 7123h: AI Input Scaling 2 PV

This object defines the process value of the second calibration point for the analog input channel, as shown in Figure 7. It is scaled in the physical unit of the PV, i.e. object 6132h applies to this object.

#### **Object Description**

Index	7123h
Name	AI Input Scaling 2 PV
Object Type	ARRAY
Data Type	INTEGER16

#### **Entry Description**

Sub-Index	0h
Description	Largest sub-index supported
Access	RO
PDO Mapping	No
Value Range	12
Default Value	12

Sub-Index	1h to Ch (x = 1 to 12)
Description	AIx Scaling 2 PV
Access	RW
PDO Mapping	No
Value Range	Integer16
Default Value	4500 [same as 7122h]

### 2.3.10. Object 7130h: AI Input Process Value

This object represents the result of the input scaling applied per Figure 7, and gives the measured quantity scaled in the physical unit of the process value (i.e. °C, PSI, RPM, etc.) with the resolution defined in object 6132h AI Decimal Digits PV.

#### **Object Description**

Index	7130h
Name	AI Input Process Value
Object Type	ARRAY
Data Type	INTEGER16

#### **Entry Description**

Sub-Index	0h
Description	Largest sub-index supported
Access	RO
PDO Mapping	No
Value Range	12
Default Value	12
Sub-Index	1h to Ch (x = 1 to 12)
Description	AIx Process Value
Access	RO
PDO Mapping	Yes
Value Range	Integer16
Default Value	No

### 2.3.11. Object 6132h: AI Decimal Digits PV

This object describes the number of digits following the decimal point (i.e. resolution) of the input data, which is interpreted with data type Integer16 in the process value object.

Example: A process value of 1.230 (Float) will be coded as 1230 in Integer16 format if the number of decimal digits is set to 3.

#### **Object Description**

Index	6123h
Name	AI Decimal Digits PV
Object Type	ARRAY
Data Type	UNSIGNED8

#### **Entry Description**

Sub-Index	0h
Description	Largest sub-index supported
Access	RO
PDO Mapping	No
Value Range	12
Default Value	12

Sub-Index	1h to Ch (x = 1 to 12)
Description	AIx Decimal Digits PV
Access	RW
PDO Mapping	No
Value Range	0 to 4
Default Value	3 [Volt to mV]

### 2.3.12. Object 7148h: AI Span Start

This value specifies the lower limit where field values are expected. Field values which are lower than this limit are marked as negative overload. It is scaled in the physical unit of the FV, i.e. object 2102h applies to this object.

#### ***Object Description***

Index	7148h
Name	AI Span Start
Object Type	ARRAY
Data Type	INTEGER16

#### ***Entry Description***

Sub-Index	0h
Description	Largest sub-index supported
Access	RO
PDO Mapping	No
Value Range	12
Default Value	12

Sub-Index	1h to Ch (x = 1 to 12)
Description	AIx Span Start (Error Min)
Access	RW
PDO Mapping	No
Value Range	See Table 11
Default Value	200 [mV]

### 2.3.13. Object 7149h: AI Span End

This value specifies the upper limit where field values are expected. Field values which are higher than this limit are marked as positive overload. It is scaled in the physical unit of the FV, i.e. object 2102h applies to this object.

#### ***Object Description***

Index	7149h
Name	AI Span End
Object Type	ARRAY
Data Type	INTEGER16



### ***Entry Description***

Sub-Index	0h
Description	Largest sub-index supported
Access	RO
PDO Mapping	No
Value Range	12
Default Value	12

Sub-Index	1h to Ch (x = 1 to 12)
Description	AIx Span End (Error Max)
Access	RW
PDO Mapping	No
Value Range	See Table 11
Default Value	4800 [mV]

### **2.3.14. Object 61A0h: AI Filter Type**

This object defines the type of data filter that will be applied to the raw input data, as read from the ADC or Timer, before it is passed to the field value object. The types of data filters are defined in Table 8, and how they are used is outlined in Section 1.3.

### ***Object Description***

Index	61A0h
Name	AI Filter Type
Object Type	ARRAY
Data Type	UNSIGNED8

### ***Entry Description***

Sub-Index	0h
Description	Largest sub-index supported
Access	RO
PDO Mapping	No
Value Range	12
Default Value	12

Sub-Index	1h to Ch (x = 1 to 12)
Description	AIx Filter Type
Access	RW
PDO Mapping	No
Value Range	See Table 8
Default Value	0 (no filter)

### 2.3.15. Object 61A1h: AI Filter Constant

This object defines the number of steps used in the various filters, as defined in Section 1.3

#### **Description**

Index	61A0h
Name	AI Filter Constant
Object Type	ARRAY
Data Type	UNSIGNED16

#### **Entry Description**

Sub-Index	0h
Description	Largest sub-index supported
Access	RO
PDO Mapping	No
Value Range	12
Default Value	12

Sub-Index	1h to Ch (x = 1 to 12)
Description	AIx Filter Constant
Access	RW
PDO Mapping	No
Value Range	1 to 1000
Default Value	10

### 2.3.16. Object 6200h: DO Write State 8 Output Lines

This object shall set a group of 8 output lines as a byte of information.

#### **Object Description**

Index	6200h
Name	DO Write State 8 Output Line
Object Type	ARRAY
Data Type	BOOLEAN

#### **Entry Description**

Sub-Index	0h
Description	Largest sub-index supported
Access	RO
PDO Mapping	No
Value Range	2
Default Value	2

Sub-Index	1h
Description	DO1-DO8 Write State
Access	RW
PDO Mapping	Yes
Value Range	0 (OFF) or 1 (ON)
Default Value	0 (OFF)

Sub-Index	2h
Description	DO9-DO12 Write State
Access	RW
PDO Mapping	Yes
Value Range	0 (OFF) or 1 (ON)
Default Value	0 (OFF)

### 2.3.17. Object 6202h: DO Polarity 8 Output Lines

This object defines the polarity of a group of 8 output lines.

#### **Object Description**

Index	6202h
Name	DO Polarity 8 Output Lines
Object Type	ARRAY
Data Type	UNSIGNED8

#### **Entry Description**

Sub-Index	0h
Description	Largest sub-index supported
Access	RO
PDO Mapping	No
Value Range	2
Default Value	2

Sub-Index	1h
Description	DO1-DO8 Polarity
Access	RW
PDO Mapping	No
Value Range	See Table 12
Default Value	0 (normal on/off)

Sub-Index	2h
Description	DO9-DO12 Polarity
Access	RW
PDO Mapping	No
Value Range	See Table 12
Default Value	0 (normal on/off)

### 2.3.18. Object 6206h: DO Fault Mode 1 Output Line

This object defines the fault mode of a group of 8 output lines (1 bit per line). The object determines the how each line shall respond when a fault condition is detected on any control input, as described in Table 13.

#### **Object Description**

Index	6206h
Name	DO Fault Mode 1 Output Line
Object Type	ARRAY
Data Type	UNSIGNED8

### ***Entry Description***

Sub-Index	0h
Description	Largest sub-index supported
Access	RO
PDO Mapping	No
Value Range	2
Default Value	2

Sub-Index	1h
Description	DO1-DO8 Fault Mode
Access	RW
PDO Mapping	No
Value Range	See Table 13
Default Value	1 (apply pre-defined state)

Sub-Index	2h
Description	DO9-DO12 Fault Mode
Access	RW
PDO Mapping	No
Value Range	See Table 13
Default Value	1 (apply pre-defined state)

### **2.3.19. Object 6207h: DO Fault State 1 Output Line**

This object defines the pre-defined state on detecting a fault condition. It is defined for a group of 8 output lines. The corresponding bit must be set in the default output line mode (Object 6206).

### ***Object Description***

Index	6207h
Name	DO Fault State 1 Output Line
Object Type	ARRAY
Data Type	BOOLEAN

### ***Entry Description***

Sub-Index	0h
Description	Largest sub-index supported
Access	RO
PDO Mapping	No
Value Range	2
Default Value	2

Sub-Index	1h
Description	DO1-DO8 Fault State
Access	RW
PDO Mapping	No
Value Range	0 (OFF) or 1 (ON)
Default Value	1 (ON)

Sub-Index	2h
Description	DO9-DO12 Fault State
Access	RW
PDO Mapping	No
Value Range	0 (OFF) or 1 (ON)
Default Value	1 (ON)

### 2.3.20. Object 7300h: AO Output Process Value

This object represents the process value of the output. It can be used as an input to the analog output function block when the input has been selected as controlled by a CANopen® Message (per Table 15 in Section 1.5).

#### **Object Description**

Index	7300h
Name	Analog Output Process Value
Object Type	ARRAY
Data Type	INTEGER16

#### **Entry Description**

Sub-Index	0h
Description	Largest sub-index supported
Access	RO
PDO Mapping	No
Value Range	12
Default Value	12

Sub-Index	1h to Ch (x = 1 to 12)
Description	Outx Process Value
Access	RW
PDO Mapping	Yes
Value Range	Integer16
Default Value	No

### 2.3.21. Object 6302h: AO Decimal Digits PV

This object describes the number of digits following the decimal point (i.e. resolution) of the output control data, which is interpreted with data type Integer16 in the process value object.

#### **Object Description**

Index	6302h
Name	AO Decimal Digits PV
Object Type	ARRAY
Data Type	UNSIGNED8

#### **Entry Description**

Sub-Index	0h
Description	Largest sub-index supported
Access	RO
PDO Mapping	No
Value Range	12
Default Value	12

Sub-Index	1h to Ch (x=1 to 12)
Description	POx Decimal Digits PV
Access	RW
PDO Mapping	No
Value Range	0 to 12
Default Value	0 [A to mA]

### 2.3.22. Object 6310h: AO Output Type

This object specifies the type of analog output, as defined in Table 14.

#### **Object Description**

Index	6310h
Name	AO Output Type
Object Type	ARRAY
Data Type	UNSIGNED16

#### **Entry Description**

Sub-Index	0h
Description	Largest sub-index supported
Access	RO
PDO Mapping	No
Value Range	12
Default Value	12

Sub-Index	1h to Ch (x=1 to 12)
Description	POx Type
Access	RW
PDO Mapping	No
Value Range	See Table 14
Default Value	20 (current)

### 2.3.23. Object 7320h: AO Output Scaling 1 PV

This object defines the minimum value of the input and should be specified to equal the corresponding scaling object of the control source, as outlined in Table 17. It will be scaled in the physical unit of the control source. The resolution will ALWAYS be dependent on object 6302h AO Decimal Digits PV, even when the output is not being controlled directly by the AO Output PV object 7300h. This object must always be smaller than object 7322h AO Output Scaling 2 PV.

#### **Object Description**

Index	7320h
Name	AO Output Scaling 1 PV
Object Type	ARRAY
Data Type	INTEGER16

### ***Entry Description***

Sub-Index	0h
Description	Largest sub-index supported
Access	RO
PDO Mapping	No
Value Range	12
Default Value	12

Sub-Index	1h to Ch (x=1 to 12)
Description	POx Scaling 1 PV
Access	RW
PDO Mapping	No
Value Range	See Table 17
Default Value	300 [mA]

### **2.3.24. Object 7321h: AO Output Scaling 1 FV**

This object defines the output field value when the input data is at or below the AO Output Scaling 1 PV value as shown in Figure 11. It will be scaled in the physical unit of the output, dependent on type, with the resolution defined in object 6332h AO Decimal Digits FV. The value can be set anywhere within the allowable output range as outlined in Table 14. This value can be set higher than object 7323h AO Output Scaling 2 FV for an inverse response (i.e. decreasing) to an increasing input.

### ***Object Description***

Index	7321h
Name	AO Output Scaling 1 FV
Object Type	ARRAY
Data Type	INTEGER16

### ***Entry Description***

Sub-Index	0h
Description	Largest sub-index supported
Access	RO
PDO Mapping	No
Value Range	12
Default Value	12

Sub-Index	1h to Ch (x=1 to 12)
Description	POx Scaling 1 FV
Access	RW
PDO Mapping	No
Value Range	Dependent on type (see Table 14)
Default Value	300 [mA]

### 2.3.25. Object 7322h: AO Output Scaling 2 PV

This object defines the maximum value of the input and should be specified to equal the corresponding scaling object of the control source, as outlined in Table 17. It will be scaled in the physical unit of the control source. The resolution will ALWAYS be dependent on object 6302h AO Decimal Digits PV, even when the output is not being controlled directly by the AO Output PV object 7300h. This object must always be larger than object 7322h AO Output Scaling 2 PV.

#### **Object Description**

Index	7322h
Name	AO Output Scaling 2 PV
Object Type	ARRAY
Data Type	INTEGER16

#### **Entry Description**

Sub-Index	0h
Description	Largest sub-index supported
Access	RO
PDO Mapping	No
Value Range	12
Default Value	12

Sub-Index	1h to Ch (x=1 to 12)
Description	POx Scaling 2 PV
Access	RW
PDO Mapping	No
Value Range	See Table 17
Default Value	1500 [mA]

### 2.3.26. Object 7323h: AO Output Scaling 2 FV

This object defines the output field value when the input data is at or above the AO Output Scaling 2 PV value as shown in Figure 11. It will be scaled in the physical unit of the output, dependent on type, with the resolution defined in object 6332h AO Decimal Digits FV. The value can be set anywhere within the allowable output range as outlined in Table 14. This value can be set lower than object 7321h AO Output Scaling 1 FV for an inverse response (i.e. decreasing) to an increasing input.

#### **Object Description**

Index	7323h
Name	AO Output Scaling 2 FV
Object Type	ARRAY
Data Type	INTEGER16

#### **Entry Description**

Sub-Index	0h
Description	Largest sub-index supported
Access	RO
PDO Mapping	No
Value Range	12
Default Value	12



Sub-Index	1h to Ch (x=1 to 12)
Description	POx Scaling 2 FV
Access	RW
PDO Mapping	No
Value Range	Dependent on type (see Table 14)
Default Value	1500 [mA]

### 2.3.27. Object 7330h: AO Output Field Value

This object represents the target output drive field value as a result of the output logic described in Section 1.5, and the scaling applied as shown in Figure 11. It is defined in the physical unit of the output dependent on type, as outlined in Table 14. The resolution of the object is defined in object 6332h AO Decimal Digits FV.

#### **Object Description**

Index	7330h
Name	Analog Output Field Value
Object Type	ARRAY
Data Type	INTEGER16

#### **Entry Description**

Sub-Index	0h
Description	Largest sub-index supported
Access	RO
PDO Mapping	No
Value Range	12
Default Value	12

Sub-Index	1h to Ch (x = 1 to 12)
Description	Outx Field Value
Access	RO
PDO Mapping	Yes
Value Range	Integer16
Default Value	No

### 2.3.28. Object 6332h: AO Decimal Digits FV

This object describes the number of digits following the decimal point (i.e. resolution) of the output data, which is interpreted with data type Integer16 in the field value object.

#### **Object Description**

Index	6332h
Name	AO Decimal Digits FV
Object Type	ARRAY
Data Type	UNSIGNED8

**Entry Description**

Sub-Index	0h
Description	Largest sub-index supported
Access	RO
PDO Mapping	No
Value Range	12
Default Value	12

Sub-Index	1h to Ch (x=1 to 12)
Description	POx Decimal Digits FV
Access	RW
PDO Mapping	No
Value Range	0 to 4
Default Value	0 [mA]

**2.3.29. Object 6340h: AO Fault Mode**

This object defines how an output shall response when a fault condition is detected on any control input, as described in Table 21.

**Object Description**

Index	6340h
Name	AO Fault Mode
Object Type	ARRAY
Data Type	UNSIGNED8

**Entry Description**

Sub-Index	0h
Description	Largest sub-index supported
Access	RO
PDO Mapping	No
Value Range	12
Default Value	12

Sub-Index	1h to Ch (x=1 to 12)
Description	Outx Fault Mode
Access	RW
PDO Mapping	No
Value Range	See Table 21
Default Value	1 (apply pre-defined FV)

### 2.3.30. Object 7341h: AO Fault Field Value

This object contains the pre-defined field value of an analog output when a fault condition is present, and the corresponding sub-index in object 7341h is enabled. It will be scaled in the physical unit of the output, dependent on type, with the resolution defined in object 6332h AO Decimal Digits FV.

#### **Object Description**

Index	7341h
Name	AO Fault Field Value
Object Type	ARRAY
Data Type	INTEGER16

#### **Entry Description**

Sub-Index	0h
Description	Largest sub-index supported
Access	RO
PDO Mapping	No
Value Range	12
Default Value	12

Sub-Index	1h to Ch (x=1 to 12)
Description	PO Fault Field Value
Access	RW
PDO Mapping	No
Value Range	Dependent on type (see Table 14)
Default Value	500 [mA]

### 2.3.31. Object 7450h: PID Proportional Band

This object describes the proportional band gain (G in Figure 14) of the PID algorithm. The value is always interpreted as having a resolution of one digit after the decimal place.

#### **Object Description**

Index	7450h
Name	PID Proportional Band
Object Type	ARRAY
Data Type	INTEGER16

#### **Entry Description**

Sub-Index	0h
Description	Largest sub-index supported
Access	RO
PDO Mapping	No
Value Range	12
Default Value	12

Sub-Index	1h to Ch (x = 1 to 12)
Description	PIDx Proportional Gain
Access	RW
PDO Mapping	No
Value Range	0 to 100 (0 to 10.0)
Default Value	5 [0.5]

### 2.3.32. Object 7452h: PID Integral Action Time

This object describes the integral time ( $T_i$  in Figure 14) of the PID algorithm. The physical unit is always seconds, as defined in object 6458h, with the decimal digits (resolution) given in object 6459h. To prevent instability, it is recommended to never set this less than three times higher than object 7454h ( $T_d$  in Figure 14).

#### **Object Description**

Index	7452h
Name	PID Integral Action Time
Object Type	ARRAY
Data Type	INTEGER16

#### **Entry Description**

Sub-Index	0h
Description	Largest sub-index supported
Access	RO
PDO Mapping	No
Value Range	12
Default Value	12

Sub-Index	1h to Ch ( $x = 1$ to 12)
Description	PID $x$ Integral Time
Access	RW
PDO Mapping	No
Value Range	0.001 [sec] to 1000.00 [sec]
Default Value	5 [ms or 0.005sec]

### 2.3.33. Object 7454h: PID Derivative Action Time

This object describes the derivative time ( $T_d$  in Figure 14) of the PID algorithm. The physical unit is always seconds, as defined in object 6458h, with the decimal digits (resolution) given in object 6459h. To prevent instability, it is recommended to never set this more than three times smaller than object 7452h ( $T_i$  in Figure 14).

#### **Object Description**

Index	7454h
Name	PID Derivative Action Time
Object Type	ARRAY
Data Type	INTEGER16

#### **Entry Description**

Sub-Index	0h
Description	Largest sub-index supported
Access	RO
PDO Mapping	No
Value Range	12
Default Value	12

Sub-Index	1h to Ch (x = 1 to 12)
Description	PIDx Derivative Time
Access	RW
PDO Mapping	No
Value Range	0.001 [sec] to 1000.00 [sec]
Default Value	1 [ms or 0.001sec]

### 2.3.34. Object 7456h: PID Cycle Time

This object defines how frequently the PID loop is called. The physical unit is always seconds, as defined in object 6458h, with the decimal digits (resolution) given in object 6459h.

#### **Object Description**

Index	7456h
Name	PID Cycle Time
Object Type	ARRAY
Data Type	INTEGER16

#### **Entry Description**

Sub-Index	0h
Description	Largest sub-index supported
Access	RO
PDO Mapping	No
Value Range	12
Default Value	12

Sub-Index	1h to Ch (x = 1 to 12)
Description	PIDx Cycle Time
Access	RW
PDO Mapping	No
Value Range	0.001 [sec] to 1000.00 [sec]
Default Value	10 [ms or 0.010sec]

### 2.3.35. Object 6458h: PID Physical Unit Timing

This read-only object defines the physical unit of objects 7452h, 7454h and 7456h. It represents “seconds” as the unit used in all cases.

#### **Object Description**

Index	6458h
Name	PID Physical Unit Timing
Object Type	ARRAY
Data Type	UNSIGNED32

#### **Entry Description**

Sub-Index	0h
Description	Largest sub-index supported
Access	RO
PDO Mapping	No
Value Range	12
Default Value	12

Sub-Index	1h to Ch (x = 1 to 12)
Description	PIDx Physical Unit Timing
Access	RO
PDO Mapping	No
Value Range	0003 0000h
Default Value	0003 0000h (seconds)

### 2.3.36. Object 6459h: PID Decimal Digits Timing

This object describes the number of digits following the decimal point (i.e. resolution) of the PID timing data, which is interpreted with data type Integer16 in objects 7452h, 7454h and 7456h.

#### ***Object Description***

Index	6459h
Name	PID Decimal Digits Timing
Object Type	ARRAY
Data Type	UNSIGNED8

#### ***Entry Description***

Sub-Index	0h
Description	Largest sub-index supported
Access	RO
PDO Mapping	No
Value Range	12
Default Value	12

Sub-Index	1h to Ch (x = 1 to 12)
Description	PIDx Decimal Digits Timing
Access	RW
PDO Mapping	No
Value Range	0 to 4
Default Value	3 [default ms]

## 2.4. MANUFACTURER OBJECTS

<b>Index (hex)</b>	<b>Object</b>	<b>Object Type</b>	<b>Data Type</b>	<b>Access</b>	<b>PDO Mapping</b>
2020	DI Pull Up/Down Mode 1 Input Line	ARRAY	UNSIGNED8	RW	No
2030	DI Debounce Filter 1 Input Line	ARRAY	UNSIGNED8	RW	No
2100	AI Input Range	ARRAY	UNSIGNED8	RW	No
2101	AI Number of Pulses Per Revolution	ARRAY	UNSIGNED16	RW	No
2102	AI Decimal Digits FV	ARRAY	UNSIGNED8	RW	No
2103	AI Filter Frequency for ADC	ARRAY	UNSIGNED8	RW	No
2110	AI Error Detect Enable	ARRAY	BOOLEAN	RW	No
2111	AI Error Clear Hysteresis	ARRAY	INTEGER16	RW	No
2112	AI Error Reaction Delay	ARRAY	UNSIGNED16	RW	No
2120	AI Third-Order Filter Power	ARRAY	UNSIGNED16	RW	No
2121	AI Third-Order Filter Input Coefficient N0	ARRAY	INTEGER16	RW	No
2122	AI Third-Order Filter Input Coefficient N1	ARRAY	INTEGER16	RW	No
2123	AI Third-Order Filter Input Coefficient N2	ARRAY	INTEGER16	RW	No
2124	AI Third-Order Filter Input Coefficient N3	ARRAY	INTEGER16	RW	No
2125	AI Third-Order Filter Output Coefficient N1	ARRAY	INTEGER16	RW	No
2126	AI Third-Order Filter Output Coefficient N2	ARRAY	INTEGER16	RW	No
2127	AI Third-Order Filter Output Coefficient N3	ARRAY	INTEGER16	RW	No
2220	DO Hotshot Current 1 Output Line	ARRAY	INTEGER16	RW	No
2221	DO Hold Current 1 Output Line	ARRAY	INTEGER16	RW	No
2222	DO Hotshot Time 1 Output Line	ARRAY	UNSIGNED16	RW	No
2223	DO Blink Rate	ARRAY	UNSIGNED16	RW	No
2224	DO Delay Time 1 Output Line	ARRAY	UNSIGNED16	RW	No
2225	DO Delay Polarity 1 Output Line	ARRAY	UNSIGNED8	RW	No
2225	DO Output Status	ARRAY	UNSIGNED8	RW	Yes
2300	AO Override Field Value	ARRAY	INTEGER16	RW	No
2310	AO Error Detect Enable	ARRAY	BOOLEAN	RW	No
2311	AO Error Clear Hysteresis	ARRAY	INTEGER16	RW	No
2312	AO Error Reaction Delay	ARRAY	UNSIGNED16	RW	No
2320	AO Dither Frequency	ARRAY	UNSIGNED16	RW	No
2321	AO Dither Amplitude	ARRAY	UNSIGNED16	RW	No
2330	AO Ramp Up	ARRAY	UNSIGNED16	RW	No
2331	AO Ramp Down	ARRAY	UNSIGNED16	RW	No
2340	AO Control Input Source	ARRAY	UNSIGNED8	RW	No
2341	AO Control Input Number	ARRAY	UNSIGNED8	RW	No
2342	AO Control Response	ARRAY	UNSIGNED8	RW	No
2350	AO Enable Input Source	ARRAY	UNSIGNED8	RW	No
2351	AO Enable Input Number	ARRAY	UNSIGNED8	RW	No
2352	AO Enable Response	ARRAY	UNSIGNED8	RW	No
2360	AO Override Input Source	ARRAY	UNSIGNED8	RW	No
2361	AO Override Input Number	ARRAY	UNSIGNED8	RW	No
2362	AO Override Response	ARRAY	UNSIGNED8	RW	No
2370	AO Feedback Field Value	ARRAY	INTEGER16	RO	Yes
2371	AO Feedback Current Field Value	ARRAY	INTEGER16	RO	Yes
2380	AO Output Frequency	ARRAY	UNSIGNED16	RW	No
2382	AO Current PID Proportional Gain	ARRAY	FLOAT32	RW	No
2383	AO Current PID Integral Time	ARRAY	FLOAT32	RW	No
2384	AO Current PID Derivative Time	ARRAY	FLOAT32	RW	No

2450	PID Tolerance	ARRAY	INTEGER16	RW	No
2451	PID Integral Gain	ARRAY	INTEGER16	RW	No
2452	PID Derivative Gain	ARRAY	INTEGER16	RW	No
2453	PID Target Source	ARRAY	UNSIGNED8	RW	No
2454	PID Target Number	ARRAY	UNSIGNED8	RW	No
2455	PID Feedback Source	ARRAY	UNSIGNED8	RW	No
2456	PID Feedback Number	ARRAY	UNSIGNED8	RW	No
2457	PID Control Response	ARRAY	UNSIGNED8	RW	No
2460	PID Output Field Value	ARRAY	INTEGER16	RO	Yes
2500	EC Extra Received Process Value	ARRAY	INTEGER16	RW	Yes
2502	EC Decimal Digits PV	ARRAY	UNSIGNED8	RW	No
2520	EC Scaling 1 PV	ARRAY	INTEGER16	RW	No
2522	EC Scaling 2 PV	ARRAY	INTEGER16	RW	No
3yz0	LTyz Input X-Axis Source	VAR	UNSIGNED8	RW	No
3yz1	LTyz Input X-Axis Number	VAR	UNSIGNED8	RW	No
3yz2	LTyz Auto Repeat	VAR	UNSIGNED8	RW	No
3yz3	LTyz X-Axis Decimal Digits PV	VAR	UNSIGNED8	RW	No
3yz4	LTyz Y-Axis Decimal Digits PV	VAR	UNSIGNED8	RW	No
3yz5	LTyz Point Response	ARRAY	UNSIGNED8	RW	No
3yz6	LTyz Point X-Axis PV	ARRAY	INTEGER32	RW	No
3yz7	LTyz Point Y-Axis PV	ARRAY	INTEGER16	RW	No
3yz8	LTyz Output Y-Axis PV	VAR	INTEGER16	RO	Yes
3300	Logic Block Enable	ARRAY	BOOLEAN	RW	No
3310	Logic Block Selected Table	ARRAY	UNSIGNED8	RO	Yes
3320	Logic Output Process Value	ARRAY	INTEGER16	RO	Yes
3x01	LB(x-3) Lookup Table Number	ARRAY	UNSIGNED8	RW	No
3x02	LB(x-3) Function Logical Operator	ARRAY	UNSIGNED8	RW	No
3x11	LB(x-3) Function A Condition 1	RECORD	UNSIGNED8	RW	No
3x12	LB(x-3) Function A Condition 2	RECORD	UNSIGNED8	RW	No
3x13	LB(x-3) Function A Condition 3	RECORD	UNSIGNED8	RW	No
3x21	LB(x-3) Function B Condition 1	RECORD	UNSIGNED8	RW	No
3x22	LB(x-3) Function B Condition 2	RECORD	UNSIGNED8	RW	No
3x23	LB(x-3) Function B Condition 3	RECORD	UNSIGNED8	RW	No
3x31	LB(x-3) Function C Condition 1	RECORD	UNSIGNED8	RW	No
3x32	LB(x-3) Function C Condition 2	RECORD	UNSIGNED8	RW	No
3x33	LB(x-3) Function C Condition 3	RECORD	UNSIGNED8	RW	No
4500	Math Block Enable	ARRAY	BOOLEAN	RW	No
4521	Math Output Scaling 1 PV	ARRAY	INTEGER16	RW	No
4523	Math Output Scaling 2 PV	ARRAY	INTEGER16	RW	No
4530	Math Output Process Value	ARRAY	INTEGER16	RO	Yes
4532	Math Output Decimal Digits PV	ARRAY	UNSIGNED8	RW	No
4y00	Math Y Input Source	ARRAY	UNSIGNED8	RW	No
4y01	Math Y Input Number	ARRAY	UNSIGNED8	RW	No
4y03	Math Y Input Decimal Digits FV	ARRAY	UNSIGNED8	RW	No
4y20	Math Y Input Scaling 1 FV	ARRAY	INTEGER16	RW	No
4y22	Math Y Input Scaling 2 FV	ARRAY	INTEGER16	RW	No
4y40	Math Y Input Gain	ARRAY	INTEGER8	RW	No
4y50	Math Y Operator	ARRAY	UNSIGNED8	RW	No



5010	Constant Field Value	ARRAY	FLOAT32	RW	No
5040	Fault Detection Field Value	ARRAY	UNSIGNED16	RO	Yes
5041	Fault Detection Set Threshold	ARRAY	UNSIGNED16	RW	No
5042	Fault Detection Clear Threshold	ARRAY	UNSIGNED16	RW	No
5050	Fault Detection Enable Err Check 8 Faults	ARRAY	UNSIGNED8	RW	No
5041	Fault Detection Error Response Delay	ARRAY	UNSIGNED16	RW	No
5555	Start in Operational Mode	VAR	BOOLEAN	RW	No

Where  $yz = 01$  to  $09$  (LUT 1 to  $09$ ) and  $x = 4$  to  $5$  (Logic 1 to 2) and  $y = 1$  to  $6$  (Math 1 to 6)

#### 2.4.1. Object 2020h: DI Pullup/Down Mode 1 Input Line

This object determines how the state read on the input pin corresponds to the logic state, in conjunction with application object 6020h, as defined in Table 3. The options for this object are listed in Table 1, and the controller will adjust the input hardware according to what is specified.

##### **Object Description**

Index	2020h
Name	DI Pullup/Down Mode 1 Input Line
Object Type	ARRAY
Data Type	UNSIGNED8

##### **Entry Description**

Sub-Index	0h
Description	Largest sub-index supported
Access	RO
PDO Mapping	No
Value Range	12
Default Value	12

Sub-Index	1h to Ch ( $x = 1$ to 12)
Description	Digital Input X Pullup/Down
Access	RW
PDO Mapping	No
Value Range	See Table 1
Default Value	0 (pullup/down disabled)

#### 2.4.2. Object 2030h: DI Debounce Filter 1 Input Line

This object will debounce the input signal applied on a single digital input as shown in Figure 4. The options for this object are listed in Table 2.

##### **Object Description**

Index	2020h
Name	DI Debounce Filter 1 Input Line
Object Type	ARRAY
Data Type	UNSIGNED8

**Entry Description**

Sub-Index	0h
Description	Largest sub-index supported
Access	RO
PDO Mapping	No
Value Range	12
Default Value	12

Sub-Index	1h to Ch (x = 1 to 12)
Description	Digital Input X Pullup/Down
Access	RW
PDO Mapping	No
Value Range	See Table 2
Default Value	2 [Filter 1.78 us]

**2.4.3. Object 2100h: AI Input Range**

This object, in conjunction with 6110h AI Sensor Type, defines the analog input defaults (Table 10) and allowable ranges (Table 11) for objects 2111h, 7120h, 7122h, 7148h and 7149h. The number and types of ranges will vary according to what type of sensor is connected to the input, as described in Table 17.

**Object Description**

Index	2100h
Name	AI Input Range
Object Type	ARRAY
Data Type	UNSIGNED8

**Entry Description**

Sub-Index	0h
Description	Largest sub-index supported
Access	RO
PDO Mapping	No
Value Range	12
Default Value	12

Sub-Index	1h to Ch (x = 1 to 12)
Description	Input X Range
Access	RW
PDO Mapping	No
Value Range	See Table 17
Default Value	2 [0-5V]

#### 2.4.4. Object 2101h: AI Number of Pulses Per Revolution

This object is only used when a “Frequency” input type has been selected by object 6110h. The controller will automatically convert frequency measurement from Hz to RPM when a non-zero value is specified. In this case, objects 2111h, 7120h, 7122h, 7148h and 7149h will be interpreted as RPM data. Object 2100h AI Input Range must still be specified in Hertz, and should be selected according to the expected frequencies that the RPM sensor will operate in.

##### ***Object Description***

Index	2101h
Name	AI Number of Pulses Per Revolution
Object Type	ARRAY
Data Type	UNSIGNED16

##### ***Entry Description***

Sub-Index	0h
Description	Largest sub-index supported
Access	RO
PDO Mapping	No
Value Range	12
Default Value	12
Sub-Index	1h to Ch (x = 1 to 12)
Description	Input x Pulses per Revolution
Access	RW
PDO Mapping	No
Value Range	0 to 1000
Default Value	1

#### 2.4.5. Object 2102h: AI Decimal Digits FV

This object describes the number of digits following the decimal point (i.e. resolution) of the input data, which is interpreted with data type Integer16 in the field value object.

Example: A field value of 1.230 (Float) will be coded as 1230 in Integer16 format if the number of decimal digits is set to 3.

In addition to the FV object 7100h, objects 2111h, 7120h, 7122h, 7148h and 7149h will also be specified with this resolution. This object is normally read-only and will be automatically adjusted by the controller as per Table 9 depending on the analog input type and range that has been selected. When object 5550h is set to FALSE (disables automatic updates), this object becomes writeable.

##### ***Object Description***

Index	2102h
Name	AI Decimal Digits FV
Object Type	ARRAY
Data Type	UNSIGNED8

**Entry Description**

Sub-Index	0h
Description	Largest sub-index supported
Access	RO
PDO Mapping	No
Value Range	12
Default Value	12

Sub-Index	1h to Ch (x = 1 to 12)
Description	Inputx Decimal Digits FV
Access	RW (only when object 5550h is false)
PDO Mapping	No
Value Range	See Table 9
Default Value	3 [Volt to mV]

**2.4.6. Object 2103h: AI Filter Frequency for ADC**

This object is used to specify the cutoff filter frequency for the ADC peripheral on the processor. The analog-to-digital converter is used with analog input types: voltage; current; and resistive. It is also used to measure: analog output current feedback, power supply voltage, and processor temperature. The available filters are listed in Table 7.

**Object Description**

Index	2104h
Name	AI Filter Frequency for ADC
Object Type	ARRAY
Data Type	UNSIGNED8

**Entry Description**

Sub-Index	0h
Description	Largest sub-index supported
Access	RO
PDO Mapping	No
Value Range	12
Default Value	12

Sub-Index	1h to Ch (x = 1 to 12)
Description	AIx ADC Filter Frequency
Access	RW
PDO Mapping	No
Value Range	See Table 7
Default Value	1 [Filter 50Hz]

### 2.4.7. Object 2110h: AI Error Detect Enable

This object enables error detection and reaction associated with the analog input function block. When disabled, the input will not generate an EMCY code in object 1003h Pre-Defined Error Field, nor will it disable any output controlled by the input should the input go out of range as defined by the objects 7148h AI Span Start and 7149h AI Span End.

#### **Object Description**

Index	2110h
Name	AI Error Detect Enable
Object Type	ARRAY
Data Type	BOOLEAN

#### **Entry Description**

Sub-Index	0h
Description	Largest sub-index supported
Access	RO
PDO Mapping	No
Value Range	12
Default Value	12

Sub-Index	1h to Ch (x = 1 to 12)
Description	Inputx Error Detect Enable
Access	RW
PDO Mapping	No
Value Range	0 (FALSE) or 1 (TRUE)
Default Value	1 [TRUE]

### 2.4.8. Object 2111h: AI Error Clear Hysteresis

This object is used to prevent rapid activation/clearing of an input fault flag and sending of object 1003h to the CANopen® network. Once the input has gone above/below the thresholds that define the valid operating range, it must come back into range minus/plus this value to clear the fault. It is scaled in the physical unit of the FV, i.e. object 2102h applies to this object.

#### **Object Description**

Index	2111h
Name	AI Error Clear Hysteresis
Object Type	ARRAY
Data Type	INTEGER16

#### **Entry Description**

Sub-Index	0h
Description	Largest sub-index supported
Access	RO
PDO Mapping	No
Value Range	12
Default Value	12

Sub-Index	1h to Ch (x = 1 to 12)
Description	Inputx Error Clear Hysteresis
Access	RW
PDO Mapping	No
Value Range	See Table 11
Default Value	100 [mV]

#### 2.4.9. Object 2112h: AI Error Reaction Delay

This object is used to filter out spurious signals and to prevent saturating the CANopen® network with broadcasts of object 1003h as the fault is set/cleared. Before the fault is recognized (i.e. the EMCY code is added to the pre-defined error field list), it must remain active throughout the period of time defined in this object. The physical unit for this object is milliseconds.

##### **Object Description**

Index	2112h
Name	AI Error Reaction Delay
Object Type	ARRAY
Data Type	UNSIGNED16

##### **Entry Description**

Sub-Index	0h
Description	Largest sub-index supported
Access	RO
PDO Mapping	No
Value Range	12
Default Value	12

Sub-Index	1h to Ch (x = 1 to 12)
Description	AIx Error Reaction Delay
Access	RW
PDO Mapping	No
Value Range	0 to 60,000
Default Value	1000 [ms]

#### 2.4.10. Object 2120h: AI Third-Order Filter Power

Third order filtering of the input data is done using 16-bit fixed point math. This object tells the controller the shift value (i.e.  $2^x$ ) that was used when the coefficients were selected. See Section 1.3 for more information on the third-order low pass filter.

##### **Object Description**

Index	2120h
Name	AI Third-Order Filter Power
Object Type	ARRAY
Data Type	UNSIGNED16

**Entry Description**

Sub-Index	0h
Description	Largest sub-index supported
Access	RO
PDO Mapping	No
Value Range	12
Default Value	12

Sub-Index	1h to Ch (x = 1 to 12)
Description	Inputx Third-Order Filter Power
Access	RW
PDO Mapping	No
Value Range	0 to 16
Default Value	10 [ $2^{10} = 1024$ ]

**2.4.11. Object 2121h: AI Third-Order Filter Input Coefficient N0**

**2.4.12. Object 2122h: AI Third-Order Filter Input Coefficient N1**

**2.4.13. Object 2123h: AI Third-Order Filter Input Coefficient N2**

**2.4.14. Object 2124h: AI Third-Order Filter Input Coefficient N3**

These objects specify the 16-bit shifted input co-efficient values used in the third-order low pass filter calculation described in Section 1.3. They are all defined with a right shift value of  $2^{10}$ . Since coefficient N3 is set to zero, the default filter is a second-order low pass.

**Object Description**

Index	2121h to 2124h (x = 0 to 3)
Name	AI 3 <sup>rd</sup> Order Filter Input Coefficient Nx
Object Type	ARRAY
Data Type	INTEGER16

**Entry Description**

Sub-Index	0h
Description	Largest sub-index supported
Access	RO
PDO Mapping	No
Value Range	12
Default Value	12

Sub-Index	1h to Ch (y = 1 to 12)
Description	Aly 3 <sup>rd</sup> Order Filter Input Coeff Nx
Access	RW
PDO Mapping	No
Value Range	-10000 to 10000
Default Value	N0=120, N1=241, N2=120, N3=0

**2.4.15. Object 2125h: AI Third-Order Filter Output Coefficient N1****2.4.16. Object 2126h: AI Third-Order Filter Output Coefficient N2****2.4.17. Object 2127h: AI Third-Order Filter Output Coefficient N3**

These objects specify the 16-bit shifted output co-efficient values used in the third-order low pass filter calculation described in Section 1.3. They are all defined with a right shift value of  $2^{10}$ . Since coefficient N3 is set to zero, the default filter is a second-order low pass.

***Object Description***

Index	2125h to 2127h (x = 1 to 3)
Name	AI 3 <sup>rd</sup> Order Filter Output Coefficient Nx
Object Type	ARRAY
Data Type	INTEGER16

***Entry Description***

Sub-Index	0h
Description	Largest sub-index supported
Access	RO
PDO Mapping	No
Value Range	12
Default Value	12

Sub-Index	1h to Ch (y = 1 to 12)
Description	Aly 3 <sup>rd</sup> Order Filter Output Coeff Nx
Access	RW
PDO Mapping	No
Value Range	-10000 to 10000
Default Value	N1=704, N2=-164, N3=0

**2.4.18. Object 2220h: DO Hotshot Current 1 Output Line**

This object is used to define the hotshot current that will be applied for the hotshot time when an output configured as a digital hotshot is turned ON. See Figure 9 for more information. The physical unit is mA, and it uses the same resolution as the AO Output FV, so object 6332 AO Decimal Digits FV applies.

***Object Description***

Index	2220h
Name	DO Hotshot Current 1 Output Line
Object Type	ARRAY
Data Type	INTEGER16

***Entry Description***

Sub-Index	0h
Description	Largest sub-index supported
Access	RO
PDO Mapping	No
Value Range	12
Default Value	12



Sub-Index	1h to Ch (x = 1 to 12)
Description	DOx Hotshot Current
Access	RW
PDO Mapping	No
Value Range	2221h (Hold Current) to I <sub>max</sub> (2.0A)
Default Value	2000 [mA]

#### 2.4.19. Object 2221h: DO Hold Current 1 Output Line

This object is used to define the hold current that will be maintained after the hotshot time while an output configured as a digital hotshot is ON. See Figure 9 for more information. The physical unit is mA, and it uses the same resolution as the AO Output FV, so object 6332 AO Decimal Digits FV applies.

##### **Object Description**

Index	2221h
Name	DO Hold Current 1 Output Line
Object Type	ARRAY
Data Type	INTEGER16

##### **Entry Description**

Sub-Index	0h
Description	Largest sub-index supported
Access	RO
PDO Mapping	No
Value Range	12
Default Value	12

Sub-Index	1h to Ch (x = 1 to 12)
Description	DOx Hold Current
Access	RW
PDO Mapping	No
Value Range	0 to 2220h (Hotshot Current)
Default Value	500 [mA]

#### 2.4.20. Object 2222h: DO Hold Time 1 Output Line

This object is used to define the time that the hotshot current will be applied when an output configured as a digital hotshot is turned ON. See Figure 9 for more information. The physical unit is milliseconds.

##### **Object Description**

Index	2222h
Name	DO Hotshot Time 1 Output Line
Object Type	ARRAY
Data Type	UNSIGNED16

**Entry Description**

Sub-Index	0h
Description	Largest sub-index supported
Access	RO
PDO Mapping	No
Value Range	12
Default Value	12

Sub-Index	1h to Ch (x = 1 to 12)
Description	DOx Hotshot Time
Access	RW
PDO Mapping	No
Value Range	0 to 60,000
Default Value	1000 [ms]

**2.4.21. Object 2223h: DO Blink Rate****Object Description**

Index	2223h
Name	DO Blink Rate
Object Type	ARRAY
Data Type	UNSIGNED16

**Entry Description**

Sub-Index	0h
Description	Largest sub-index supported
Access	RO
PDO Mapping	No
Value Range	12
Default Value	12

Sub-Index	1h to Ch (x = 1 to 12)
Description	Outx Blink rate
Access	RW
PDO Mapping	No
Value Range	0 to 60,000
Default Value	0 [ms]

#### 2.4.22. Object 2224h: DO Delay Time 1 Output Line

This object is used only when an ON/OFF digital output has been specified for a normal ON/OFF response by object 6202h DO Polarity (only applies to Normal ON/OFF). While the DO is commanded, the output will remain in the previous state until the time specified in this object has elapsed prior to changing to the commanded state. The physical unit is milliseconds. The polarity for which the delay will take effect is specified by object 2225h.

##### ***Object Description***

Index	2225h
Name	DO Delay Time Output Line
Object Type	ARRAY
Data Type	UNSIGNED16

##### ***Entry Description***

Sub-Index	0h
Description	Largest sub-index supported
Access	RO
PDO Mapping	No
Value Range	12
Default Value	12

Sub-Index	1h to Ch (x = 1 to 12)
Description	Outx Delay Time
Access	RW
PDO Mapping	No
Value Range	0 to 60,000
Default Value	0 [ms]

#### 2.4.23. Object 2225h: DO Delay Polarity 1 Output Line

This object is used only when an ON/OFF digital output has been specified for a normal ON/OFF response by object 6202h DO Polarity (only applies to Normal ON/OFF). While the DO is commanded to the state specified by this object, the output will remain in the previous state until the time specified by object 2224h has elapsed prior to driving the output to the commanded state.

##### ***Object Description***

Index	2225h
Name	DO Delay Time Output Line
Object Type	ARRAY
Data Type	UNSIGNED8

##### ***Entry Description***

Sub-Index	0h
Description	Largest sub-index supported
Access	RO
PDO Mapping	No
Value Range	12
Default Value	12

Sub-Index	1h to Ch (x = 1 to 12)
Description	Outx Delay Time
Access	RW
PDO Mapping	No
Value Range	0 (OFF) to 1 (ON)
Default Value	1 [ON]

#### 2.4.24. Object 2230h: DO Output Status

##### **Object Description**

Index	2230h
Name	DO Output Status
Object Type	ARRAY
Data Type	UNSIGNED8

##### **Entry Description**

Sub-Index	0h
Description	Largest sub-index supported
Access	RO
PDO Mapping	Yes
Value Range	12
Default Value	12

Sub-Index	1h to Ch (x = 1 to 12)
Description	Outx Status
Access	RW
PDO Mapping	No
Value Range	0 (Inactive) to 3 (Short circuit)
Default Value	0 [Inactive]

#### 2.4.25. Object 2300h: AO Override Field Value

This object contains the pre-defined field value of an analog output when an override condition is active. It will be scaled in the physical unit of the output, dependent on type, with the resolution defined in object 6332h AO Decimal Digits FV.

##### **Object Description**

Index	2300h
Name	AO Override FV
Object Type	ARRAY
Data Type	INTEGER16

##### **Entry Description**

Sub-Index	0h
Description	Largest sub-index supported
Access	RO
PDO Mapping	No
Value Range	12
Default Value	12

Sub-Index	1h to Ch (x = 1 to 12)
Description	POx Override FV
Access	RW
PDO Mapping	No
Value Range	Dependent on type (see Table 14)
Default Value	750 [mA]

#### 2.4.26. Object 2310h: AO Error Detect Enable

This object enables error detection and reaction associated with the analog output function block. When disabled, the input will not generate an EMCY code in object 1003h Pre-Defined Error Field should the control detect an open/short circuit at the load.

##### ***Object Description***

Index	2310h
Name	AO Error Detect Enable
Object Type	ARRAY
Data Type	BOOLEAN

##### ***Entry Description***

Sub-Index	0h
Description	Largest sub-index supported
Access	RO
PDO Mapping	No
Value Range	12
Default Value	12

Sub-Index	1h to Ch (x = 1 to 12)
Description	POx Error Detect Enable
Access	RW
PDO Mapping	No
Value Range	0 (FALSE) or 1 (TRUE)
Default Value	1 [TRUE]

#### 2.4.27. Object 2311h: AO Error Clear Hysteresis

This object is used to define the absolute difference that can be tolerated between the target output (as commanded by the control input) and the measured feedback. Any difference outside of the value will flag an open or short circuit fault. It is scaled in the physical unit of the output FV, i.e. object 6332h applies to this object.

##### ***Object Description***

Index	2311h
Name	AO Error Clear Hysteresis
Object Type	ARRAY
Data Type	INTEGER16

**Entry Description**

Sub-Index	0h
Description	Largest sub-index supported
Access	RO
PDO Mapping	No
Value Range	12
Default Value	12

Sub-Index	1h to Ch (x = 1 to 12)
Description	AOx Error Clear Hysteresis
Access	RW
PDO Mapping	No
Value Range	0 to 10% of 7321h or 7323h, whichever is larger
Default Value	100 [mA]

**2.4.28. Object 2312h: AO Error Reaction Delay**

This object is used to filter out spurious signals and to prevent saturating the CANopen® network with broadcasts of object 1003h as the fault is set/cleared. Before the fault is recognized (i.e. the EMCY code is added to the pre-defined error field list), it must remain active throughout the period of time defined in this object. The physical unit for this object is milliseconds.

**Object Description**

Index	2312h
Name	AO Error Reaction Delay
Object Type	ARRAY
Data Type	UNSIGNED16

**Entry Description**

Sub-Index	0h
Description	Largest sub-index supported
Access	RO
PDO Mapping	No
Value Range	12
Default Value	12

Sub-Index	1h to Ch (x = 1 to 12)
Description	POx Error Reaction Delay
Access	RW
PDO Mapping	No
Value Range	0 to 60,000
Default Value	1000 [ms]

#### 2.4.29. Object 2320h: AO Dither Frequency

This object defines the low frequency that is superimposed on the high output frequency (object 2380h) when an AO is configured as a current output. The dither frequency should be selected such that the valve will respond immediately to small changes in current. The physical unit for this object is Hertz.

##### **Object Description**

Index	2320h
Name	AO Dither Frequency
Object Type	ARRAY
Data Type	UNSIGNED16

##### **Entry Description**

Sub-Index	0h
Description	Largest sub-index supported
Access	RO
PDO Mapping	No
Value Range	12
Default Value	12

Sub-Index	1h to Ch (x = 1 to 12)
Description	POx Dither Frequency
Access	RW
PDO Mapping	No
Value Range	50 to 400
Default Value	250 [Hz]

#### 2.4.30. Object 2321h: AO Dither Amplitude

This object defines the amplitude of the low frequency signal that is superimposed on the output when an AO is configured as a current output. A zero value in this object disables the dithering feature. Note, the actual dither amplitude will not match exactly what is defined in this object, as it will be dependent on the inductance of the coil. Rather, this object should be adjusted such that the valve will respond immediately to small changes in current. The physical unit for this object is milliamps. Object 6332h does NOT apply.

##### **Object Description**

Index	2321h
Name	AO Dither Amplitude
Object Type	ARRAY
Data Type	UNSIGNED16

##### **Entry Description**

Sub-Index	0h
Description	Largest sub-index supported
Access	RO
PDO Mapping	No
Value Range	12
Default Value	12

Sub-Index	1h to Ch (x = 1 to 12)
Description	AOx Dither Amplitude
Access	RW
PDO Mapping	No
Value Range	0 to 500
Default Value	0 [mA] (dithering disabled)

#### 2.4.31. Object 2330h: AO Ramp Up

This object defines the time it will take to ramp from the minimum output PV to the maximum as defined by objects 7321h and 7323h. It can be used to soften the response to a step change at the input. The physical unit for this object is milliseconds.

##### **Object Description**

Index	2330h
Name	AO Ramp Up
Object Type	ARRAY
Data Type	UNSIGNED16

##### **Entry Description**

Sub-Index	0h
Description	Largest sub-index supported
Access	RO
PDO Mapping	No
Value Range	12
Default Value	12

Sub-Index	1h to Ch (x = 1 to 12)
Description	POx Ramp Up
Access	RW
PDO Mapping	No
Value Range	0 to 60,000
Default Value	1000 [ms]

#### 2.4.32. Object 2331h: AO Ramp Down

This object defines the time it will take to ramp from the maximum output PV to the minimum as defined by objects 7321h and 7323h. It can be used to soften the response to a step change at the input. The physical unit for this object is milliseconds.

##### **Object Description**

Index	2331h
Name	AO Ramp Down
Object Type	ARRAY
Data Type	UNSIGNED16



**Entry Description**

Sub-Index	0h
Description	Largest sub-index supported
Access	RO
PDO Mapping	No
Value Range	12
Default Value	12

Sub-Index	1h to Ch (x = 1 to 12)
Description	POx Ramp Down
Access	RW
PDO Mapping	No
Value Range	0 to 60,000
Default Value	1000 [ms]

**2.4.33. Object 2340h: AO Control Input Source**

This object defines the type of input that will be used to control the analog (or digital) output as shown in the logic flowchart in Figure 6. The available control sources on the controller are listed in Table 15. Not all sources would make sense to control the AO, and it is the user's responsibility to select a source that makes sense for the application.

**Object Description**

Index	2340h
Name	AO Control Input Source
Object Type	ARRAY
Data Type	UNSIGNED8

**Entry Description**

Sub-Index	0h
Description	Largest sub-index supported
Access	RO
PDO Mapping	No
Value Range	12
Default Value	12

Sub-Index	1h to Ch (x = 1 to 12)
Description	Outx Control Input Source
Access	RW
PDO Mapping	No
Value Range	See Table 15
Default Value	1 (CANopen® RPDO)

#### 2.4.34. Object 2341h: AO Control Input Number

This object defines the number of the source that will be used to control the analog (or digital) output as shown in the logic flowchart in Figure 6. The available control numbers are dependent on the source selected, as shown in Table 16. Once selected, the control represents the process value (X-Axis input) in Figure 11. Objects 6302h, 7320h, 7322h should therefore be updated to match the scaling limits defined by the control source/number, as listed in Table 17.

##### ***Object Description***

Index	2341h
Name	AO Control Input Number
Object Type	ARRAY
Data Type	UNSIGNED8

##### ***Entry Description***

Sub-Index	0h
Description	Largest sub-index supported
Access	RO
PDO Mapping	No
Value Range	12
Default Value	12

Sub-Index	1h to Ch (x = 1 to 12)
Description	Outx Control Input Number
Access	RW
PDO Mapping	No
Value Range	See Table 16
Default Value	x (CANopen® Message x)

#### 2.4.35. Object 2342h: AO Control Response

This object defines the response profile of the analog output FV with respect to the input PV (as selected by objects 2340h/2341h.) Normally it will follow the profile shown in Figure 11. However, in some cases the offset will be disabled (i.e. output at 0) when the PV is below 7320h Scaling 1 PV or alternatively above the 7322h Scaling 2 PV. The options for this object are listed in Table 18. When an output is configured as a digital output using object 6310h then this object is ignored, and object 6202h, DO Polarity, is used instead.

##### ***Object Description***

Index	2342h
Name	AO Control Response
Object Type	ARRAY
Data Type	UNSIGNED8

**Entry Description**

Sub-Index	0h
Description	Largest sub-index supported
Access	RO
PDO Mapping	No
Value Range	12
Default Value	12

Sub-Index	1h to Ch (x = 1 to 12)
Description	Outx Control Response
Access	RW
PDO Mapping	No
Value Range	See Table 18
Default Value	1 (Output OFF below Scaling 1 PV)

**2.4.36. Object 2350h: AO Enable Input Source**

This object defines the type of input that will be used to enable/disable the analog (or digital) output as shown in the logic flowchart in Figure 6. The available control sources on the controller are listed in Table 15. Not all sources would make sense to enable the AO, and it is the user's responsibility to select a source that makes sense for the application.

**Object Description**

Index	2350h
Name	AO Enable Input Source
Object Type	ARRAY
Data Type	UNSIGNED8

**Entry Description**

Sub-Index	0h
Description	Largest sub-index supported
Access	RO
PDO Mapping	No
Value Range	12
Default Value	12

Sub-Index	1h to Ch (x = 1 to 12)
Description	Outx Enable Input Source
Access	RW
PDO Mapping	No
Value Range	See Table 15
Default Value	0 (control not used)

### 2.4.37. Object 2351h: AO Enable Input Number

This object defines the number of the source that will be used to enable/disable the analog (or digital) output as shown in the logic flowchart in Figure 6. The available control numbers are dependent on the source selected, as shown in Table 16.

#### **Object Description**

Index	2351h
Name	AO Enable Input Number
Object Type	ARRAY
Data Type	UNSIGNED8

#### **Entry Description**

Sub-Index	0h
Description	Largest sub-index supported
Access	RO
PDO Mapping	No
Value Range	12
Default Value	12

Sub-Index	1h to Ch (x = 1 to 12)
Description	Outx Enable Input Number
Access	RW
PDO Mapping	No
Value Range	See Table 16
Default Value	0 (null control source)

### 2.4.38. Object 2352h: AO Enable Response

This object determines if the input will act as an enable or safety interlock (i.e. input must be ON to engage the output) or a disable signal (i.e. the output will shutoff when the input is ON.) The options for this object for analog output 1 to 4 are listed in Table 19.

#### **Object Description**

Index	2352h
Name	AO Enable Response
Object Type	ARRAY
Data Type	UNSIGNED8

#### **Entry Description**

Sub-Index	0h
Description	Largest sub-index supported
Access	RO
PDO Mapping	No
Value Range	12
Default Value	12

Sub-Index	1h to Ch (x = 1 to 12)
Description	Outx Enable Response
Access	RW
PDO Mapping	No
Value Range	See Table 19
Default Value	3 (Enable When Off, Else Shut Off )

#### 2.4.39. Object 2360h: AO Override Input Source

This object defines the type of input that will be used to active the override value for the analog outputs as shown in the logic flowchart in Figure 6. The available control sources are listed in Table 15. Not all sources would make sense to enable the AO, and it is the user's responsibility to select a source that makes sense for the application.

##### **Object Description**

Index	2360h
Name	AO Override Input Source
Object Type	ARRAY
Data Type	UNSIGNED8

##### **Entry Description**

Sub-Index	0h
Description	Largest sub-index supported
Access	RO
PDO Mapping	No
Value Range	12
Default Value	12

Sub-Index	1h to Ch (x = 1 to 12)
Description	Outx Override Input Source
Access	RW
PDO Mapping	No
Value Range	See Table 15
Default Value	0 (control not used)

#### 2.4.40. Object 2361h: AO Override Input Number

This object defines the number of the source that will be used to override the analog outputs as shown in the logic flowchart in Figure 6. The available control numbers are dependent on the source selected, as shown in Table 16.

##### **Object Description**

Index	2361h
Name	AO Override Input Number
Object Type	ARRAY
Data Type	UNSIGNED8

**Entry Description**

Sub-Index	0h
Description	Largest sub-index supported
Access	RO
PDO Mapping	No
Value Range	12
Default Value	12

Sub-Index	1h to Ch (x = 1 to 12)
Description	Outx Override Input Number
Access	RW
PDO Mapping	No
Value Range	See Table 16
Default Value	0 (null control source)

**2.4.41. Object 2362h: AO Override Response**

This object determines how the override command will respond to the input state. The options for this object are listed in Table 20.

**Object Description**

Index	2362h
Name	AO Override Response
Object Type	ARRAY
Data Type	UNSIGNED8

**Entry Description**

Sub-Index	0h
Description	Largest sub-index supported
Access	RO
PDO Mapping	No
Value Range	12
Default Value	12

Sub-Index	1h to Ch (x = 1 to 12)
Description	Outx Override Response
Access	RW
PDO Mapping	No
Value Range	See Table 20
Default Value	0 (Override When On)

#### 2.4.42. Object 2370h: AO Feedback Field Value

This read-only object reflects the actual measured current feedback of an output. For other output types (i.e. voltage, PWM or digital,) it will reflect the target Output FV or State (for DO type) based on PV vs. FV calculations (see Figure 11) and applied ramps. It can be mapped to a PDO for diagnostic purposes. It will be scaled in the physical unit of the output, dependent on type, with the resolution defined in object 6332h AO Decimal Digits FV.

##### ***Object Description***

Index	2370h
Name	AO Feedback Field Value
Object Type	ARRAY
Data Type	INTEGER16

##### ***Entry Description***

Sub-Index	0h
Description	Largest sub-index supported
Access	RO
PDO Mapping	No
Value Range	12
Default Value	12

Sub-Index	1h to Ch (x = 1 to 12)
Description	Outx Feedback Field Value
Access	RO
PDO Mapping	Yes
Value Range	Dependent on type (see Table 14)
Default Value	No

#### 2.4.43. Object 2371h: AO Feedback Current Field Value

This read-only object reflects the actual measured current feedback of an output. For all output types, this object will always hold the value of the measured feedback current in milliamps.

##### ***Object Description***

Index	2371h
Name	AO Feedback Current Field Value
Object Type	ARRAY
Data Type	INTEGER16

##### ***Entry Description***

Sub-Index	0h
Description	Largest sub-index supported
Access	RO
PDO Mapping	No
Value Range	12
Default Value	12

Sub-Index	1h to Ch (x = 1 to 12)
Description	Outx Feedback Current Field Value
Access	RO
PDO Mapping	Yes
Value Range	INTEGER16
Default Value	0 [mA]

#### 2.4.44. Object 2380h: AO Output Frequency

This object is used to set the frequency of the outputs. However, because some outputs share the same timers, if any output in its respective bank is configured as a Current or Hotshot type, the output frequency will remain 25kHz. For the controller to change the output frequency of the bank, none of the outputs (in their bank) can be configured as any of these two types.

##### **Object Description**

Index	2380h
Name	AO Output Frequency
Object Type	ARRAY
Data Type	INTEGER16

##### **Entry Description**

Sub-Index	0h
Description	Largest sub-index supported
Access	RO
PDO Mapping	No
Value Range	12
Default Value	12

Sub-Index	1, 4, 7-10 (x=1, 4, 7-10)
Description	POx Frequency
Access	RW
PDO Mapping	No
Value Range	1000-25,000 Hertz
Default Value	25,000 [Hz]

Sub-Index	2, 3, 11 (x=2, 3, 11)
Description	POx Frequency
Access	RO
PDO Mapping	No
Value Range	Same value as 2380h subindex 1
Default Value	Same value as 2380h subindex 1

Sub-Index	5, 6, 12 (x=5, 6, 12)
Description	POx Frequency
Access	RO
PDO Mapping	No
Value Range	Same value as 2380h subindex 4
Default Value	Same value as 2380h subindex 4



#### 2.4.45. Object 2382h: AO Current PID Proportional Gain

This object has been factory calibrated and should be changed with caution. Axiomatic will no longer guarantee the accuracy or responsiveness of the current output when this value is changed. It is provided as a writeable object in case the output frequency is changed, and the user wants to try and optimize the current PID loop. Axiomatic does not recommend this.

##### **Object Description**

Index	2382h
Name	AO Current PID Proportional Gain
Object Type	ARRAY
Data Type	FLOAT32

##### **Entry Description**

Sub-Index	0h
Description	Largest sub-index supported
Access	RO
PDO Mapping	No
Value Range	12
Default Value	12

Sub-Index	1h to Ch (x = 1 to 12)
Description	POx Current PID Proportional Gain
Access	RW
PDO Mapping	No
Value Range	FLOAT32
Default Value	0.10

#### 2.4.46. Object 2383h: AO Current PID Integral Time

This object has been factory calibrated and should be changed with caution. Axiomatic will no longer guarantee the accuracy or responsiveness of the current output when this value is changed. It is provided as a writeable object in case the output frequency is changed, and the user wants to try and optimize the current PID loop. Axiomatic does not recommend this.

##### **Object Description**

Index	2383h
Name	AO Current PID Integral Time
Object Type	ARRAY
Data Type	FLOAT32

##### **Entry Description**

Sub-Index	0h
Description	Largest sub-index supported
Access	RO
PDO Mapping	No
Value Range	12
Default Value	12

Sub-Index	1h to Ch (x = 1 to 12)
Description	POx Current PID Integral Time
Access	RW
PDO Mapping	No
Value Range	FLOAT32
Default Value	0.0015

#### 2.4.47. Object 2384h: AO Current PID Derivative Time

This object has been factory calibrated and should be changed with caution. Axiomatic will no longer guarantee the accuracy or responsiveness of the current output when this value is changed. It is provided as a writeable object in case the output frequency is changed, and the user wants to try and optimize the current PID loop. Axiomatic does not recommend this.

##### ***Object Description***

Index	2384h
Name	AO Current PID Derivative Time
Object Type	ARRAY
Data Type	FLOAT32

##### ***Entry Description***

Sub-Index	0h
Description	Largest sub-index supported
Access	RO
PDO Mapping	No
Value Range	12
Default Value	12

Sub-Index	1h to Ch (x = 1 to 12)
Description	POx Current PID Derivative Time
Access	RW
PDO Mapping	No
Value Range	FLOAT32
Default Value	0.0000

#### 2.4.48. Object 2450h: PID Tolerance

This object defines the allowable absolute difference between the target and the feedback, below which the error will be interpreted as zero (i.e. PID output stops changing). The physical unit for this object is percentage, and the value is always interpreted as having a resolution of one digit after the decimal place.

##### ***Object Description***

Index	2450h
Name	PID Tolerance
Object Type	ARRAY
Data Type	INTEGER16

### ***Entry Description***

Sub-Index	0h
Description	largest sub-index supported
Access	RO
PDO Mapping	No
Value Range	12
Default Value	12

Sub-Index	1h to Ch (x = 1 to 12)
Description	PIDx Tolerance
Access	RW
PDO Mapping	No
Value Range	0 to 100 (0% to 10%)
Default Value	10 [1%]

### **2.4.49. Object 2451h: PID Integral Gain**

This object describes the integral gain ( $K_i$  in Figure 14) of the PID algorithm. The value is always interpreted as having a resolution of one digit after the decimal place.

### ***Object Description***

Index	2451h
Name	PID Integral Gain
Object Type	ARRAY
Data Type	INTEGER16

### ***Entry Description***

Sub-Index	0h
Description	Largest sub-index supported
Access	RO
PDO Mapping	No
Value Range	12
Default Value	12

Sub-Index	1h to Ch (x = 1 to 12)
Description	PIDx Integral Gain
Access	RW
PDO Mapping	No
Value Range	0 to 100
Default Value	10 [1.0]

### **2.4.50. Object 2452h: PID Derivative Gain**

This object describes the derivative gain ( $K_d$  in Figure 14) of the PID algorithm. The value is always interpreted as having a resolution of one digit after the decimal place.

### ***Object Description***

Index	2452h
Name	PID Derivative Gain
Object Type	ARRAY
Data Type	INTEGER16

**Entry Description**

Sub-Index	0h
Description	Largest sub-index supported
Access	RO
PDO Mapping	No
Value Range	12
Default Value	12

Sub-Index	1h to Ch (x = 1 to 12)
Description	PIDx Derivative Gain
Access	RW
PDO Mapping	No
Value Range	0 to 100
Default Value	10 [1.0]

**2.4.51. Object 2453h: PID Target Source**

This object defines the type of input that will be used to determine the target process value for the PID control loop. The available control sources are listed in Table 15. Not all sources would make sense to use as a PID target source, and it is the user's responsibility to select a source that makes sense for the application. A selection of "Control Source Not Used" disables the associated PID control function block.

**Object Description**

Index	2453h
Name	PID Target Source
Object Type	ARRAY
Data Type	UNSIGNED8

**Entry Description**

Sub-Index	0h
Description	Largest sub-index supported
Access	RO
PDO Mapping	No
Value Range	12
Default Value	12

Sub-Index	1h to Ch (x = 1 to 12)
Description	PIDx Target Source
Access	RW
PDO Mapping	No
Value Range	See Table 15
Default Value	0 (control not used, PID disabled)

### 2.4.52. Object 2454h: PID Target Number

This object defines the number of the source that will be used as the target PV for the PID control loop. The available control numbers are dependent on the source selected, as shown in Table 16. Once selected, the control will convert the commanded target into a percentage value using the scaling limits of the control source/number as defined in Table 17.

#### ***Object Description***

Index	2454h
Name	PID Target Number
Object Type	ARRAY
Data Type	UNSIGNED8

#### ***Entry Description***

Sub-Index	0h
Description	Largest sub-index supported
Access	RO
PDO Mapping	No
Value Range	12
Default Value	12

Sub-Index	1h to Ch (x = 1 to 12)
Description	PID <sub>x</sub> Target Number
Access	RW
PDO Mapping	No
Value Range	See Table 16
Default Value	0

### 2.4.53. Object 2455h: PID Feedback Source

This object defines the type of input that will be used to determine the feedback process value for the PID control loop. The available control sources are listed in Table 15. Not all sources would make sense to use as a PID feedback source, and it is the user's responsibility to select a source that makes sense for the application. A selection of "Control Source Not Used" disables the associated PID control function block.

#### ***Object Description***

Index	2455h
Name	PID Feedback Source
Object Type	ARRAY
Data Type	UNSIGNED8

#### ***Entry Description***

Sub-Index	0h
Description	Largest sub-index supported
Access	RO
PDO Mapping	No
Value Range	12
Default Value	12

Sub-Index	1h to Ch (x = 1 to 12)
Description	PIDx Feedback Source
Access	RW
PDO Mapping	No
Value Range	See Table 15
Default Value	0 (control not used, PID disabled)

#### 2.4.54. Object 2456h: PID Feedback Number

This object defines the number of the source that will be used as the feedback PV for the PID control loop. The available control numbers are dependent on the source selected, as shown in Table 16. Once selected, the control will convert the measured/received feedback into a percentage value using the scaling limits of the control source/number as defined in Table 17.

##### **Object Description**

Index	2456h
Name	PID Feedback Number
Object Type	ARRAY
Data Type	UNSIGNED8

##### **Entry Description**

Sub-Index	0h
Description	Largest sub-index supported
Access	RO
PDO Mapping	No
Value Range	12
Default Value	12

Sub-Index	1h to Ch (x = 1 to 12)
Description	PIDx Feedback Number
Access	RW
PDO Mapping	No
Value Range	See Table 16
Default Value	<b>0</b>

#### 2.4.55. Object 2457h: PID Control Response

This object defines the output profile for the PID control function block in a push-pull dual output system. The options for this object are listed in Table 22.

##### **Object Description**

Index	2457h
Name	PID Control Response
Object Type	ARRAY
Data Type	UNSIGNED8

**Entry Description**

Sub-Index	0h
Description	Largest sub-index supported
Access	RO
PDO Mapping	No
Value Range	12
Default Value	12

Sub-Index	1h to Ch (x = 1 to 12)
Description	PIDx Control Response
Access	RW
PDO Mapping	No
Value Range	See Table 22
Default Value	0 (single output)

**2.4.56. Object 2460h: PID Output Field Value**

This read-only output contains the PID control function block FV (as a percentage) that can be used as the input source for another function block (i.e. analog output.) It will be a value between 0 to 100% as per the algorithm defined in Figure 14. The physical unit for this object is percentage, and the value is always interpreted as having a resolution of one digit after the decimal place.

**Object Description**

Index	2460h
Name	PID Output FV
Object Type	ARRAY
Data Type	INTEGER16

**Entry Description**

Sub-Index	0h
Description	Largest sub-index supported
Access	RO
PDO Mapping	No
Value Range	12
Default Value	12

Sub-Index	1h to Ch (x = 1 to 12)
Description	PIDx Output FV
Access	RO
PDO Mapping	Yes
Value Range	0 to 1000 (0 to 100%)
Default Value	No

#### 2.4.57. Object 2500h: EC Extra Received Process Value

This object provides an extra control source in order to allow other function blocks to be controlled by data received from a CANopen® RPDO. It functions similarly to any other writeable, mappable PV object, such as 7300h AO Output PV.

##### **Object Description**

Index	2500h
Name	EC Extra Received Process Value
Object Type	ARRAY
Data Type	INTEGER16

##### **Entry Description**

Sub-Index	0h
Description	Largest sub-index supported
Access	RO
PDO Mapping	No
Value Range	10
Default Value	10

Sub-Index	1h to Ah (x = 1 to 10)
Description	ECx Received Process Value
Access	RW
PDO Mapping	Yes
Value Range	Integer16
Default Value	No

#### 2.4.58. Object 2502h: EC Decimal Digits PV

This object describes the number of digits following the decimal point (i.e. resolution) of the extra control data, which is interpreted with data type Integer16 in the process value object.

##### **Object Description**

Index	2502h
Name	EC Decimal Digits PV
Object Type	ARRAY
Data Type	UNSIGNED8

##### **Entry Description**

Sub-Index	0h
Description	Largest sub-index supported
Access	RO
PDO Mapping	No
Value Range	10
Default Value	10



Sub-Index	1h to Ah (x = 1 to 10)
Description	ECx Decimal Digits PV
Access	RW
PDO Mapping	No
Value Range	0 to 4
Default Value	1 (0.1 resolution)

#### 2.4.59. Object 2520h: EC Scaling 1 PV

This object defines the minimum value of the extra control source. It used as the Scaling 1 value by other functions blocks when the EC has been selected as the source for the X-Axis data, i.e. as seen in Figure 11. There is no physical unit associate with the data, but it uses the same resolution as the received PV as defined in object 2502h, EC Decimal Digits PV. This object must always be smaller than object 2522h EC Scaling 2 PV.

##### ***Object Description***

Index	2520h
Name	EC Scaling 1 PV
Object Type	ARRAY
Data Type	INTEGER16

##### ***Entry Description***

Sub-Index	0h
Description	Largest sub-index supported
Access	RO
PDO Mapping	No
Value Range	10
Default Value	10

Sub-Index	1h to Ah (x = 1 to 10)
Description	ECx Scaling 1 PV
Access	RW
PDO Mapping	No
Value Range	-32768 to 2522h sub-index X
Default Value	0

#### 2.4.60. Object 2522h: EC Scaling 2 PV

This object defines the maximum value of the extra control source. It used as the Scaling 2 value by other functions blocks when the EC has been selected as the source for the X-Axis data, i.e. as seen in Figure 11. There is no physical unit associate with the data, but it uses the same resolution as the received PV as defined in object 2502h, EC Decimal Digits PV. This object must always be larger than object 2520h EC Scaling 1 PV.

##### ***Object Description***

Index	2522h
Name	EC Scaling 2 PV
Object Type	ARRAY
Data Type	INTEGER16

**Entry Description**

Sub-Index	0h
Description	Largest sub-index supported
Access	RO
PDO Mapping	No
Value Range	10
Default Value	10

Sub-Index	1h to Ah (x = 1 to 10)
Description	ECx Scaling 2 PV
Access	RW
PDO Mapping	No
Value Range	2520h sub-index X to 32767
Default Value	1000 (100.0)

**2.4.61. Object 3yz0h: LTyz Input X-Axis Source**

This object defines the type of input that will be used to determine the X-Axis input process value for the lookup table function. The available control sources are listed in Table 15. Not all sources would make sense to use as an X-Axis input, and it is the user's responsibility to select a source that makes sense for the application. A selection of "Control Source Not Used" disables the associated lookup table function block.

**Object Description**

Index	3yz0h (where yz = 01 to 09)
Name	LTyz Input X-Axis Source
Object Type	VARIABLE
Data Type	UNSIGNED8

**Entry Description**

Sub-Index	0h
Access	RW
PDO Mapping	No
Value Range	See Table 15
Default Value	0 (control not used)

**2.4.62. Object 3yz1h: LTyz Input X-Axis Number**

This object defines the number of the source that will be used as the X-Axis input PV for the lookup table function. The available control numbers are dependent on the source selected, as shown in Table 16. Once selected, the limits for the points on the X-Axis will be constrained by the scaling objects of the control source/number as defined in Table 17.

**Object Description**

Index	3yz1h (where yz = 01 to 09)
Name	LTyz Input X-Axis Number
Object Type	VARIABLE
Data Type	UNSIGNED8

**Entry Description**

Sub-Index	0h
Access	RW
PDO Mapping	No
Value Range	See Table 16
Default Value	0 (null control source)

**2.4.63. Object 3yz2h: LTyz Auto Repeat**

This object determines whether the lookup table sequence will repeat automatically once the last point in the lookup table has been completed. This object is only taken into effect when the response is set to 'Time Response'. For more details on the functionality of this object and its effect on the lookup table, please refer to section 1.7.4

**Object Description**

Index	3yz2h (where yz = 01 to 09)
Name	LTyz X-Axis Decimal Digits PV
Object Type	VARIABLE
Data Type	UNSIGNED8

**Entry Description**

Sub-Index	0h
Access	RW
PDO Mapping	No
Value Range	0 (OFF) to 1 (ON)
Default Value	0 [OFF]

**2.4.64. Object 3yz3h: LTyz X-Axis Decimal Digits PV**

This object describes the number of digits following the decimal point (i.e. resolution) of the X-Axis input data and the points in the lookup table. It should be set equal to the decimal digits used by the PV from the control source/number as defined in Table 17.

**Object Description**

Index	3yz3h (where yz = 01 to 09)
Name	LTyz X-Axis Decimal Digits PV
Object Type	VARIABLE
Data Type	UNSIGNED8

**Entry Description**

Sub-Index	0h
Access	RW
PDO Mapping	No
Value Range	0 to 4 (see Table 17)
Default Value	0

#### 2.4.65. Object 3yz4h: LTyz Y-Axis Decimal Digits PV

This object describes the number of digits following the decimal point (i.e. resolution) of the Y-Axis points in the lookup table. When the Y-Axis output is going to be the input to another function block (i.e. an analog output), it is recommended that this value be set equal to the decimal digits used by the block that is using the lookup table as the control source/number.

##### **Object Description**

Index	3yz4h (where yz = 01 to 09)
Name	LTyz Y-Axis Decimal Digits PV
Object Type	VARIABLE
Data Type	UNSIGNED8

##### **Entry Description**

Sub-Index	0h
Access	RW
PDO Mapping	No
Value Range	0 to 4
Default Value	0

#### 2.4.66. Object 3yz5h: LTyz Point Response

This object determines the Y-Axis output response to changes in the X-Axis input. The value set in sub-index 1 determines the X-Axis type (i.e. data or time), while all other sub-indexes determine the response (ramp, step, ignore) between two points on the curve. The options for this object are listed in Table 23. See Figure 16 for an example of the difference between a step and ramp response.

##### **Object Description**

Index	3yz5h (where yz = 01 to 09)
Name	LTyz Point Response
Object Type	ARRAY
Data Type	UNSIGNED8

##### **Entry Description**

Sub-Index	0h
Description	Largest sub-index supported
Access	RO
PDO Mapping	No
Value Range	11
Default Value	11

Sub-Index	1h
Description	X-Axis Type
Access	RW
PDO Mapping	No
Value Range	See Table 23 (0 or 1)
Default Value	0 (x-axis data response)

Sub-Index	2h to Bh (x = 2 to 11)
Description	LTyz Point X Response
Access	RW
PDO Mapping	No
Value Range	See Table 23 (0, 1 or 2)
Default Value	1 (ramp to response)

#### 2.4.67. Object 3yz6h: LTyz Point X-Axis PV

This object defines the X-Axis data for the 11 calibration points on the lookup table, resulting in 10 different output slopes.

When a data response is selected for the X-Axis type (sub-index 1 of object 3yz5), this object is constrained such that X1 cannot be less than the Scaling 1 value of the selected control source/number, and X11 cannot be more than the Scaling 2 value. The rest of the points are constrained by the formula below. The physical unit associate with the data will be that of the selected input, and it will use the resolution defined in object 3yz3h, LTz X-Axis Decimal Digits PV.

$$\text{MinInt16} \leq X_1 \leq X_2 \leq X_3 \leq X_4 \leq X_5 \leq X_6 \leq X_7 \leq X_8 \leq X_9 \leq X_{10} \leq X_{11} \leq \text{MaxInt16}$$

When a time response has been selected, each point on the X-Axis can be set anywhere from 1 to 86,400,000ms.

#### **Object Description**

Index	3yz6h (where yz = 01 to 09)
Name	LTyz Point X-Axis PV
Object Type	ARRAY
Data Type	INTEGER32

#### **Entry Description**

Sub-Index	0h
Description	Largest sub-index supported
Access	RO
PDO Mapping	No
Value Range	11
Default Value	11

Sub-Index	1h to Bh (x = 1 to 11)	
Description	LTyz Point X-Axis PVx	
Access	RW	
PDO Mapping	No	
Value Range	See above (data)	1 to 86400000 (time)
Default Value	10*(x-1)	No

#### 2.4.68. Object 3yz7h: LTyz Point Y-Axis PV

This object defines the Y-Axis data for the 11 calibration points on the lookup table, resulting in 10 different output slopes. The data is unconstrained and has no physical unit associate with it. It will use the resolution defined in object 3yz4h, LTyz Y-Axis Decimal Digits PV.

##### **Object Description**

Index	3yz7h (where yz = 01 to 09)
Name	LTz Point Y-Axis PV
Object Type	ARRAY
Data Type	INTEGER16

##### **Entry Description**

Sub-Index	0h
Description	Largest sub-index supported
Access	RO
PDO Mapping	No
Value Range	11
Default Value	11

Sub-Index	1h to Bh (x = 1 to 11)
Description	LTyz Point Y-Axis PVx
Access	RW
PDO Mapping	No
Value Range	Integer16
Default Value	10*(x-1) [i.e. 0, 10, 20, 30, ... 100]

#### 2.4.69. Object 3yz8h: LTyz Output Y-Axis PV

This read-only object contains the lookup table function block PV that can be used as the input source for another function block (i.e. analog output.) The physical unit for this object is undefined, and it will use the resolution defined in object 3yz4h, LTz Y-Axis Decimal Digits PV.

##### **Object Description**

Index	3yz8h (where yz = 01 to 09)
Name	LTyz Output Y-Axis PV
Object Type	VARIABLE
Data Type	INTEGER16

##### **Entry Description**

Sub-Index	0h
Access	RO
PDO Mapping	Yes
Value Range	Integer16
Default Value	No

### 2.4.70. Object 3300h: Logic Block Enable

This object defines whether or not the logic shown in Figure 19 will be evaluated.

#### **Object Description**

Index	3300h
Name	Logic Block Enable
Object Type	ARRAY
Data Type	BOOLEAN

#### **Entry Description**

Sub-Index	0h
Description	Largest sub-index supported
Access	RO
PDO Mapping	No
Value Range	4
Default Value	4

Sub-Index	1h to 2h (x = 1 to 2)
Description	LBx Enable
Access	RW
PDO Mapping	No
Value Range	0 (FALSE) or 1 (TRUE)
Default Value	0 [FALSE]

### 2.4.71. Object 3310h: Logic Block Selected Table

This read-only object reflects what table has been selected as the output source for the logic block after the evaluation shown in Figure 19 has been performed.

#### **Object Description**

Index	3310h
Name	Logic Block Selected Table
Object Type	ARRAY
Data Type	UNSIGNED8

#### **Entry Description**

Sub-Index	0h
Description	Largest sub-index supported
Access	RO
PDO Mapping	No
Value Range	4
Default Value	4

Sub-Index	1h to 3h (x = 1 to 3)
Description	LBx Selected Table
Access	RO
PDO Mapping	Yes
Value Range	1 to 9
Default Value	No

#### 2.4.72. Object 3320h: Logic Block Output PV

This read-only object reflects the output from the selected table, interpreted as a percentage. The limits for the percentage conversion are based on the range of the lookup tables Y-Axis Output PV as shown in Table 28. This value has a fixed decimal digit value of 1 giving a resolution of 0.1%.

##### **Object Description**

Index	3320h
Name	Logic Block Output PV
Object Type	ARRAY
Data Type	UNSIGNED8

##### **Entry Description**

Sub-Index	0h
Description	Largest sub-index supported
Access	RO
PDO Mapping	No
Value Range	4
Default Value	4

Sub-Index	1h to 3h (x = 1 to 3)
Description	LBx Output PV
Access	RO
PDO Mapping	Yes
Value Range	Dependent on Selected Table
Default Value	No

#### 2.4.73. Object 3x01h: LB(x-3) Lookup Table Numbers

This object determines which of the six lookup tables are associated with a particular function within the given logic block. Up to three tables can be linked to each logic function.

##### **Object Description**

Index	3x01h (where x = 4 to 6)
Name	LB(x-3) Lookup Table Numbers
Object Type	ARRAY
Data Type	UNSIGNED8

##### **Entry Description**

Sub-Index	0h
Description	Largest sub-index supported
Access	RO
PDO Mapping	No
Value Range	4
Default Value	4

Sub-Index	1h to 4h (y = A to C)
Description	LB(x-3) Lookup Table Y Number
Access	RW
PDO Mapping	No
Value Range	1 to 9
Default Value	See Table 18



#### 2.4.74. Object 3x02h: LB(x-3) Function Logical Operator

This object determines how the results of the three conditions for each function are to be compared to one another to determine the overall state of the function output. There are up to three functions that can be evaluated in each logic block. The options for this object are defined in Table 27. See Section 1.8 for more information about how this object is used.

##### **Object Description**

Index	3x02h (where x = 4 to 6)
Name	LB(x-3) Function Logical Operator
Object Type	ARRAY
Data Type	UNSIGNED8

##### **Entry Description**

Sub-Index	0h
Description	Largest sub-index supported
Access	RO
PDO Mapping	No
Value Range	4
Default Value	4

Sub-Index	1h to 4h (y = A to C)
Description	LB(x-3) Function Y Logical Operator
Access	RW
PDO Mapping	No
Value Range	See Table 27
Default Value	Function A = 1 (and all) Function B = 1 (and all) Function C = 0 (default)

- 2.4.75. Object 3x11h: LB(x-3) Function A Condition 1
- 2.4.76. Object 3x12h: LB(x-3) Function A Condition 2
- 2.4.77. Object 3x13h: LB(x-3) Function A Condition 3
- 2.4.78. Object 3x21h: LB(x-3) Function B Condition 1
- 2.4.79. Object 3x22h: LB(x-3) Function B Condition 2
- 2.4.80. Object 3x23h: LB(x-3) Function B Condition 3
- 2.4.81. Object 3x31h: LB(x-3) Function C Condition 1
- 2.4.82. Object 3x32h: LB(x-3) Function C Condition 2
- 2.4.83. Object 3x33h: LB(x-3) Function C Condition 3

These objects, 3xyzh, represent Logic Block z, Function y, Condition z, where x = 4 to 6, y = 1 (A) to 3 (C), and z = 1 to 3. All of these objects are a special type of record, defined in Table 24. Information on how to use these objects is defined in Section 1.8.

##### **Object Description**

Index	3xyzh
Name	LB(x-3) Function y Condition z
Object Type	RECORD
Data Type	UNSIGNED8

**Entry Description**

Sub-Index	0h
Description	Largest sub-index supported
Access	RO
PDO Mapping	No
Value Range	5
Default Value	5

Sub-Index	1h
Description	Argument 1 Source
Access	RW
PDO Mapping	No
Value Range	See Table 15
Default Value	1 (CANopen® Message)

Sub-Index	2h
Description	Argument 1 Number
Access	RW
PDO Mapping	No
Value Range	See Table 16
Default Value	11 (EC Received PV 1)

Sub-Index	3h
Description	Argument 2 Source
Access	RW
PDO Mapping	No
Value Range	See Table 15
Default Value	5 (Constant PV)

Sub-Index	4h
Description	Argument 2 Number
Access	RW
PDO Mapping	No
Value Range	See Table 16
Default Value	3 (Constant FV 3)

Sub-Index	5h
Description	Operator
Access	RW
PDO Mapping	No
Value Range	See Table 14
Default Value	0 (Equals)

#### 2.4.84. Object 3900h: Set-Reset Latch Enable

The corresponding sub-index of object must be set TRUE in order for a SR Latch function block to be enabled. Otherwise, the output will always be at 0.

##### ***Object Description***

Index	3900h
Name	SR Latch Enable
Object Type	ARRAY
Data Type	BOOLEAN

##### ***Entry Description***

Sub-Index	0h
Description	Largest sub-index supported
Access	RO
PDO Mapping	No
Value Range	5
Default Value	5

Sub-Index	1h to 5h (Y = 1 to 5)
Description	SR Latch Y Enable
Access	RW
PDO Mapping	No
Value Range	0 (FALSE) or 1 (TRUE)
Default Value	0 [FALSE]

#### 2.4.85. Object 3910h: Set-Reset Latch Output Process Value

##### ***Object Description***

Index	3910h
Name	Set-Reset Latch Output PV
Object Type	ARRAY
Data Type	UNSIGNED8

##### ***Entry Description***

Sub-Index	0h
Description	Largest sub-index supported
Access	RO
PDO Mapping	No
Value Range	5
Default Value	5

Sub-Index	1h to 5h (X = 5 to 5)
Description	Logic Block X Output PV
Access	RO
PDO Mapping	Yes
Value Range	0/1 (False/True)
Default Value	0 (False)

#### 2.4.86. Object 39x1h: Set-Reset Latch [x] Reset Signal Source

##### **Object Description**

Index	39x1h
Name	Set-Reset Latch Reset Signal Source
Object Type	ARRAY
Data Type	UNSIGNED8

##### **Entry Description**

Sub-Index	0h
Description	SR Latch x Reset Signal Source
Access	RW
PDO Mapping	No
Value Range	See table 15
Default Value	0

#### 2.4.87. Object 39x2h: Set-Reset Latch [x] Reset Signal Number

##### **Object Description**

Index	39x2h
Name	SR Latch Reset Signal Number
Object Type	ARRAY
Data Type	UNSIGNED8

##### **Entry Description**

Sub-Index	0h
Description	SR Latch x Reset Signal Number
Access	RW
PDO Mapping	No
Value Range	Input Dependent, see table 15
Default Value	0

#### 2.4.88. Object 39x3h: Set-Reset Latch [x] Reset Signal OFF Threshold

##### **Object Description**

Index	39x3h
Name	SR Latch Reset Signal OFF Threshold
Object Type	ARRAY
Data Type	FLOAT32

##### **Entry Description**

Sub-Index	0h
Description	SR Latch x Reset Signal OFF Threshold
Access	RW
PDO Mapping	No
Value Range	0.0-100.0 [%]
Default Value	0.0 [%]

#### 2.4.89. Object 39x4h: Set-Reset Latch [x] Reset Signal ON Threshold

##### **Object Description**

Index	39x4h
Name	SR Latch Reset Signal ON Threshold
Object Type	ARRAY
Data Type	FLOAT32

##### **Entry Description**

Sub-Index	0h
Description	SR Latch x Reset Signal ON Threshold
Access	RW
PDO Mapping	No
Value Range	0.0-100.0 [%]
Default Value	100.0 [%]

#### 2.4.90. Object 39x5h: Set-Reset Latch [x] Set Signal Source

##### **Object Description**

Index	39x5h
Name	Set-Reset Latch Set Signal Source
Object Type	ARRAY
Data Type	UNSIGNED8

##### **Entry Description**

Sub-Index	0h
Description	SR Latch x Set Signal Source
Access	RW
PDO Mapping	No
Value Range	See Table 15
Default Value	0

#### 2.4.91. Object 39x6h: Set-Reset Latch [x] Set Signal Number

##### **Object Description**

Index	39x6h
Name	SR Latch Set Signal Number
Object Type	ARRAY
Data Type	UNSIGNED8

##### **Entry Description**

Sub-Index	0h
Description	SR Latch x Set Signal Number
Access	RW
PDO Mapping	No
Value Range	Input Dependent, see table 15
Default Value	0

#### 2.4.92. Object 39x7h: Set-Reset Latch [x] Set Signal OFF Threshold

##### **Object Description**

Index	39x7h
Name	SR Latch Set Signal OFF Threshold
Object Type	ARRAY
Data Type	FLOAT32

##### **Entry Description**

Sub-Index	0h
Description	SR Latch x Set Signal OFF Threshold
Access	RW
PDO Mapping	No
Value Range	0.0-100.0 [%]
Default Value	0.0 [%]

#### 2.4.93. Object 39x8h: Set-Reset Latch [x] Set Signal ON Threshold

##### **Object Description**

Index	39x8h
Name	SR Latch Set Signal ON Threshold
Object Type	ARRAY
Data Type	FLOAT32

##### **Entry Description**

Sub-Index	0h
Description	SR Latch x Set Signal ON Threshold
Access	RW
PDO Mapping	No
Value Range	0.0-100.0 [%]
Default Value	100.0 [%]

#### 2.4.94. Object 4000h: Math Function Enable

The corresponding sub-index of object must be set TRUE in order for a math function block to be enabled. Otherwise, the output will always be at 0.

##### **Object Description**

Index	4000h
Name	Math Function Enable
Object Type	ARRAY
Data Type	BOOLEAN

##### **Entry Description**

Sub-Index	0h
Description	Largest sub-index supported
Access	RO
PDO Mapping	No
Value Range	2
Default Value	2
Sub-Index	1h to 6h (Y = 1 to 6)

Description	Math Y Enable
Access	RW
PDO Mapping	No
Value Range	0 (FALSE) or 1 (TRUE)
Default Value	0 [FALSE]

#### 2.4.95. Object 4021h: Math Output Scaling 1 PV

This object defines the process value that would correspond to 0% output from the math calculation. The object would apply the resolution defined in object 4532h Math Output Decimal Digits PV. The physical unit is undefined.

##### **Object Description**

Index	4021h
Name	Math Output Scaling 1 PV
Object Type	ARRAY
Data Type	INTEGER16

##### **Entry Description**

Sub-Index	0h
Description	Largest sub-index supported
Access	RO
PDO Mapping	No
Value Range	6
Default Value	6

Sub-Index	1h to 6h (Y = 1 to 6)
Description	Math Y Output Scaling 1 PV
Access	RW
PDO Mapping	No
Value Range	-32768 to 32767
Default Value	0

#### 2.4.96. Object 4023h: Math Output Scaling 2 PV

This object defines the process value that would correspond to 100% output from the math calculation. The object would apply the resolution defined in object 4532h Math Output Decimal Digits PV. The physical unit is undefined.

##### **Object Description**

Index	4023h
Name	Math Output Scaling 2 PV
Object Type	ARRAY
Data Type	INTEGER16

### ***Entry Description***

Sub-Index	0h
Description	Largest sub-index supported
Access	RO
PDO Mapping	No
Value Range	6
Default Value	6

Sub-Index	1h to 6h (Y = 1 to 6)
Description	Math Y Output Scaling 2 PV
Access	RW
PDO Mapping	No
Value Range	-32768 to 32767
Default Value	10000 (100.00)

## **2.4.97. Object 4030h: Math Output Process Value**

This read-only object reflects the output from the math function block after it has been scaled by objects 4021h and 4023h. The object would apply the resolution defined in object 4032h Math Output Decimal Digits PV. The physical unit is undefined.

### ***Object Description***

Index	4030h
Name	Math Output Process Value
Object Type	ARRAY
Data Type	INTEGER16

### ***Entry Description***

Sub-Index	0h
Description	Largest sub-index supported
Access	RO
PDO Mapping	No
Value Range	6
Default Value	6

Sub-Index	1h to 6h (Y = 1 to 6)
Description	Math Y Output Process Value
Access	RO
PDO Mapping	Yes
Value Range	-32768 to 32767
Default Value	No



#### 2.4.98. Object 4032h: Math Output Decimal Digits PV

This object describes the number of digits following the decimal point (i.e. resolution) of the output data, which is interpreted with data type Integer16 in the process value object.

##### **Object Description**

Index	4032h
Name	Math Output Decimal Digits PV
Object Type	ARRAY
Data Type	UNSIGNED8

##### **Entry Description**

Sub-Index	0h
Description	Largest sub-index supported
Access	RO
PDO Mapping	No
Value Range	6
Default Value	6

Sub-Index	1h to 6h (Y = 1 to 6)
Description	Math Y Decimal Digits PV
Access	RW
PDO Mapping	No
Value Range	0 to 4
Default Value	2 (0.01)

#### 2.4.99. Object 4y00h: Math Y Input Source

This object defines the input sources that will be used in the mathematical calculations. Here, y = 1 to 6 – representing Math Block 1 to Math Block 6. If a control source is not used, the associate mathematical calculation would be ignored. The available control sources are listed in Table 15.

##### **Object Description**

Index	4y00h (y = 1 to 6)
Name	Math Y Input Source
Object Type	ARRAY
Data Type	UNSIGNED8

##### **Entry Description**

Sub-Index	0h
Description	Largest sub-index supported
Access	RO
PDO Mapping	No
Value Range	4
Default Value	4

Sub-Index	1h to 4h (X = 1 to 4)
Description	Math Y Input X Source
Access	RW
PDO Mapping	No
Value Range	See Table 15
Default Value	0 (control source not used)

#### 2.4.100. Object 4y01h: Math Y Input Number

This object defines the number of the input source that will be used in the math calculation. The available control numbers are dependent on the source selected, as shown in Table 16. Once selected, the input value will be used in the corresponding calculation as described in Section 1.9.

##### ***Object Description***

Index	4y01h (y = 1 to 6)
Name	Math Y Input Number
Object Type	ARRAY
Data Type	UNSIGNED8

##### ***Entry Description***

Sub-Index	0h
Description	Largest sub-index supported
Access	RO
PDO Mapping	No
Value Range	4
Default Value	4

Sub-Index	1h to 4h (X = 1 to 4)
Description	Math Y Input X Number
Access	RW
PDO Mapping	No
Value Range	See Table 16
Default Value	0 (null input)

#### 2.4.101. Object 4y03h: Math Y Input Decimal Digits FV

This object describes the number of digits following the decimal point (i.e. resolution) of the input data, which is interpreted with data type Integer16 in the field value object.

##### ***Object Description***

Index	4y03h (y = 1 to 6)
Name	Math Y Input Decimal Digits FV
Object Type	ARRAY
Data Type	UNSIGNED8

### ***Entry Description***

Sub-Index	0h
Description	Largest sub-index supported
Access	RO
PDO Mapping	No
Value Range	4
Default Value	4

Sub-Index	1h to 4h (X = 1 to 4)
Description	Math Y Input X Decimal Digits PV
Access	RW
PDO Mapping	No
Value Range	0 to 4
Default Value	2 (0.01)

### **2.4.102. Object 4y20h: Math Y Input Scaling 1 FV**

This object defines the input field value that would correspond to 0% when scaling the input for use in the math calculation. All inputs are normalized to a percentage before being used by the math function block. The object would apply the resolution defined in object 4y03h Math Y Input Decimal Digits FV. The physical unit would match that of the input source.

### ***Object Description***

Index	4y20h (y = 1 to 6)
Name	Math Y Input Scaling 1 FV
Object Type	ARRAY
Data Type	INTEGER16

### ***Entry Description***

Sub-Index	0h
Description	Largest sub-index supported
Access	RO
PDO Mapping	No
Value Range	4
Default Value	4

Sub-Index	1h to 4h (X = 1 to 4)
Description	Math Y Input X Scaling 1 FV
Access	RW
PDO Mapping	No
Value Range	INTEGER16
Default Value	0

### 2.4.103. Object 4y22h: Math Y Input Scaling 2 FV

This object defines the input field value that would correspond to 100% when scaling the input for use in the math calculation. All inputs are normalized to a percentage before being used by the math function block. The object would apply the resolution defined in object 4y03h Math Y Input Decimal Digits FV. The physical unit would match that of the input source.

#### **Object Description**

Index	4y22h (y = 1 to 6)
Name	Math Y Input Scaling 2 FV
Object Type	ARRAY
Data Type	INTEGER16

#### **Entry Description**

Sub-Index	0h
Description	Largest sub-index supported
Access	RO
PDO Mapping	No
Value Range	4
Default Value	4

Sub-Index	1h to 4h (X = 1 to 4)
Description	Math Y Input X Scaling 2 FV
Access	RW
PDO Mapping	No
Value Range	INTEGER16
Default Value	10000 (100.00%)

### 2.4.104. Object 4y40h: Math Y Input Gain

This object can be used to adjust the 'weight' of the input in the math calculation. It is a multiplier of the input after it has been converted into a percentage, before it is used in the math calculation. This object has a fixed resolution of 2 decimal digits.

#### **Object Description**

Index	4y40h (y = 1 to 6)
Name	Math Y Input Gain
Object Type	ARRAY
Data Type	INTEGER8

#### **Entry Description**

Sub-Index	0h
Description	Largest sub-index supported
Access	RO
PDO Mapping	No
Value Range	4
Default Value	4

Sub-Index	1h to 4h (X = 1 to 4)
Description	Math Y Input X Gain
Access	RW
PDO Mapping	No
Value Range	-100 to 100
Default Value	100 (1.0)

#### 2.4.105. Object 4y50h: Math Y Operator

This object defines the actual operators that will be used in each stage of a math calculation, as described in Section 1.9. The options for this object are listed in Table 30.

##### ***Object Description***

Index	4y50h (y = 1 to 6)
Name	Math Y Operator
Object Type	ARRAY
Data Type	UNSIGNED8

##### ***Entry Description***

Sub-Index	0h
Description	Largest sub-index supported
Access	RO
PDO Mapping	No
Value Range	3
Default Value	3

Sub-Index	1h to 3h (X = 1 to 3)
Description	Math Y Function X Operator
Access	RW
PDO Mapping	No
Value Range	See Table 30
Default Value	12 (Plus)

#### 2.4.106. Object 4B00h: Conditional Logic Block Enable

##### ***Object Description***

Index	4B00h
Name	Conditional Logic Block Enable
Object Type	ARRAY
Data Type	UNSIGNED8

##### ***Entry Description***

Sub-Index	0h
Description	Largest sub-index supported
Access	RO
PDO Mapping	No
Value Range	10
Default Value	10

Sub-Index	1h to 10h (X = 1 to 10)
Description	Logic Block X Enable
Access	RW
PDO Mapping	No
Value Range	0/1 (Disabled/Enabled)
Default Value	0 (False)

#### 2.4.107. Object 4B01h: Conditional Logic Result Operator

This object defines the result operator (operator 3) that will be used in the Conditional Logic, as described in Section 1.10.

##### **Object Description**

Index	4B01h
Name	Conditional Logic Result Operator
Object Type	ARRAY
Data Type	UNSIGNED8

##### **Entry Description**

Sub-Index	0h
Description	Largest sub-index supported
Access	RO
PDO Mapping	No
Value Range	10
Default Value	10

Sub-Index	1h to 10h (X = 1 to 10)
Description	Cond Logic Block X Result Operator
Access	RW
PDO Mapping	No
Value Range	See Table 32
Default Value	0 (OR)

#### 2.4.108. Object 4B10h: Conditional Logic Output Process Value

##### **Object Description**

Index	4B10h
Name	Conditional Logic Block Output PV
Object Type	ARRAY
Data Type	UNSIGNED8

##### **Entry Description**

Sub-Index	0h
Description	Largest sub-index supported
Access	RO
PDO Mapping	No
Value Range	10
Default Value	10

Sub-Index	1h to 10h (X = 1 to 10)
Description	Logic Block X Output PV
Access	RO
PDO Mapping	Yes
Value Range	0/1 (False/True)
Default Value	0 (False)

#### 2.4.109. Object 4Bxyh: Conditional Logic Block [x] Condition [y] Parameters

These objects represent Conditional Logic Block x, Condition y, where x = 1 to 10, y = 1 (A) to 2 (B). All of these objects are a special type of record, defined in Table 24. Information on how to use these objects is defined in Section 1.8.

##### **Object Description**

Index	4Bxyh (x=1 to 10) (y=1 to 2)
Name	Cond Logic x Condition y
Object Type	RECORD
Data Type	UNSIGNED8

##### **Entry Description**

Sub-Index	0h
Description	Largest sub-index supported
Access	RO
PDO Mapping	No
Value Range	5
Default Value	5

Sub-Index	1h
Description	Argument 1 Source
Access	RW
PDO Mapping	No
Value Range	See Table 15
Default Value	1 (CANopen® Message)

Sub-Index	2h
Description	Argument 1 Number
Access	RW
PDO Mapping	No
Value Range	See Table 16
Default Value	11 (EC Received PV 1)

Sub-Index	3h
Description	Argument 2 Source
Access	RW
PDO Mapping	No
Value Range	See Table 15
Default Value	5 (Constant PV)

Sub-Index	4h
Description	Argument 2 Number
Access	RW
PDO Mapping	No
Value Range	See Table 16
Default Value	3 (Constant FV 3)

Sub-Index	5h
Description	Operator
Access	RW
PDO Mapping	No
Value Range	See Table 31
Default Value	0 (Equals)

#### 2.4.110. Object 5010h: Constant Field Value

This object is provided to allow the user to compare against a fixed value, i.e. for setpoint control in a PID loop, or in a conditional evaluation for a logic block. The first two values in this object are fixed at FALSE (0) and TRUE (1). There are ten other sub-indexes provide for other unconstrained data.

##### ***Object Description***

Index	5010h
Name	Constant Field Value
Object Type	ARRAY
Data Type	FLOAT32

##### ***Entry Description***

Sub-Index	0
Description	Largest sub-index supported
Access	RO
PDO Mapping	No
Value Range	15
Default Value	15

Sub-Index	1
Description	Constant False
Access	RO
PDO Mapping	No
Value Range	0
Default Value	0 (false)

Sub-Index	2
Description	Constant True
Access	RO
PDO Mapping	No
Value Range	1
Default Value	1 (true)



Sub-Index	3
Description	Constant FV 3
Access	RW
PDO Mapping	No
Value Range	Float32
Default Value	3.141593

Sub-Index	4
Description	Constant FV 4
Access	RW
PDO Mapping	No
Value Range	Float32
Default Value	2.718282

Sub-Index	5
Description	Constant FV 5
Access	RW
PDO Mapping	No
Value Range	Float32
Default Value	1.414214

Sub-Index	6
Description	Constant FV 6
Access	RW
PDO Mapping	No
Value Range	Float32
Default Value	1.732051

Sub-Index	7
Description	Constant FV 7
Access	RW
PDO Mapping	No
Value Range	Float32
Default Value	2.236068

Sub-Index	8
Description	Constant FV 8
Access	RW
PDO Mapping	No
Value Range	Float32
Default Value	2.50

Sub-Index	9
Description	Constant FV 9
Access	RW
PDO Mapping	No
Value Range	Float32
Default Value	5.00

Sub-Index	10
Description	Constant FV 10
Access	RW
PDO Mapping	No
Value Range	Float32
Default Value	10.00

Sub-Index	11
Description	Constant FV 11
Access	RW
PDO Mapping	No
Value Range	Float32
Default Value	20.00

Sub-Index	12
Description	Constant FV 12
Access	RW
PDO Mapping	No
Value Range	Float32
Default Value	40.00

Sub-Index	13
Description	Constant FV 13
Access	RW
PDO Mapping	No
Value Range	Float32
Default Value	60.00

Sub-Index	14
Description	Constant FV 14
Access	RW
PDO Mapping	No
Value Range	Float32
Default Value	80.00

Sub-Index	15
Description	Constant FV 15
Access	RW
PDO Mapping	No
Value Range	Float32
Default Value	1000.00

## 2.4.111. Object 5040h: Fault Detection Field Value

This read-only object is available for diagnostic feedback purposes. It reflects the measured over/under voltage powering the controller as well as the internal microcontroller temperature. The physical unit for this object is volts and °C, respectively.

### **Object Description**

Index	5040h
Name	Power Supply Field Value
Object Type	VARIABLE
Data Type	FLOAT32

### **Entry Description**

Sub-Index	0h
Access	RO
PDO Mapping	Yes
Value Range	3
Default Value	3

Sub-Index	1h
Description	Over Temperature Field Value
Access	RO
PDO Mapping	Yes
Value Range	0 to 1250 [°C x 10]
Default Value	0

Sub-Index	2h
Description	Over Voltage Field Value
Access	RO
PDO Mapping	Yes
Value Range	0 to 500 [V x 10]
Default Value	0

Sub-Index	3h
Description	Under Voltage Field Value
Access	RO
PDO Mapping	Yes
Value Range	0 to 500 [V x 10]
Default Value	0

## 2.4.112. Object 5041h: FD Set Threshold

This object sets the value that will flag a fault detection error in the 10 Analog Input if the measured field value (5040h) goes above (FD 1 and FD 2) or below (FD 3) this limit. If error checking on the fault is enabled by object 5050h, then the module will flag an appropriate error on that channel. This value must be in the same units as the field value for the fault, as determined by the sub-index.

### **Object Description**

Index	5041h
Name	FD Set Threshold
Object Type	ARRAY
Data Type	UNSIGNED16

### **Entry Description**

Subindex	0h
Description	Number of entries
Access	RO
PDO Mapping	No
Value Range	3
Default Value	3

Sub-index	1h
Description	Over Temperature Set Threshold
Access	RW
PDO Mapping	No
Value Range	5042h at sub-index 1 to 1250 [°C x 10]
Default Value	1100 (110.0°C)

Sub-index	2h
Description	Over Voltage Set Threshold
Access	RW
PDO Mapping	No
Value Range	5042h at sub-index 2 to 1000 [V x 10]
Default Value	500 (50.0V)

Sub-index	3h
Description	Under Voltage Set Threshold
Access	RW
PDO Mapping	No
Value Range	80 to 5042h at sub-index 3 [V x 10]
Default Value	90 (9.0V)

### 2.4.113. Object 5042h: FD Clear Threshold

This object sets the value that will clear a fault detection error in the 10 Analog Input if the measured field value (5040h) goes below (FD 1 and FD 2) or above (FD 3) this threshold. This value must be in the same units as the field value for the fault, as determined by the sub-index.

#### ***Object Description***

Index	5042h
Name	FD Clear Threshold
Object Type	ARRAY
Data Type	UNSIGNED16

#### ***Entry Description***

Subindex	0h
Description	Number of entries
Access	RO
PDO Mapping	No
Value Range	3
Default Value	3

Subindex	1h
Description	Over Temperature Clear Threshold
Access	RW
PDO Mapping	No
Value Range	500 to 5041h at subindex 1 [°C x 10]
Default Value	850 (85.0°C)

Subindex	2h
Description	Over Voltage Clear Threshold
Access	RW
PDO Mapping	No
Value Range	5042h at subindex 3 to 5041h at subindex 2 [V x 10]
Default Value	480 (48.0V)

Subindex	3h
Description	Under Voltage Clear Threshold
Access	RW
PDO Mapping	No
Value Range	5041h at subindex 3 to 5042h at subindex 2 [V x 10]
Default Value	120 (12.0V)

#### 2.4.114. Object 5050h: FD Enable Error Check 8 Faults

This object enables or disables the fault detection error-checking feature for each fault detectable by the controller. The bitmap for this object at sub-index 1 is:

- Bit 0: Over Temperature Detection
- Bit 1: Over Voltage Detection
- Bit 2: Under Voltage Detection

##### **Object Description**

Index	5050h
Name	FD Enable Error Checking 8 Faults
Object Type	ARRAY
Data Type	UNSIGNED8

##### **Entry Description**

Sub-index	0h
Description	Number of entries
Access	RO
PDO Mapping	No
Value Range	1
Default Value	1

Sub-index	1h
Description	Error Check for FD 1 to FD 3
Access	RW
PDO Mapping	No
Value Range	Bit Value 0 = Error Check Disabled Bit Value 1 = Error Check Enabled
Default Value	00h (all error check disabled)

#### 2.4.115. Object 5051h: FD Error Response Delay

This object is used to prevent intermittent faults from overloading the bus with error messages. The value is defined as a multiple of 1ms. If a fault has been present during the entirety of the delay time, the Controller will flag an error of the detected fault once the timer has expired. The object can be set to zero, in which case a fault will immediately trigger an error response.

##### **Object Description**

Index	5051h
Name	FD Error Response Delay
Object Type	ARRAY
Data Type	UNSIGNED16

##### **Entry Description**

Subindex	0h
Description	Number of entries
Access	RO
PDO Mapping	No
Value Range	3
Default Value	3

Subindex	1h to 3h
Description	Error Delay, FD 1 to FD 3
Access	RW
PDO Mapping	No
Value Range	0 to 10000 [ms]
Default Value	5000 [ms]

#### 2.4.116. Object 5550h: Enable Automatic Updates

This object allows the controller to update objects to defaults automatically when an output type is changed. By default this object is TRUE.

##### ***Object Description***

Index	5550h
Name	Enable Auto Updates
Object Type	VARIABLE
Data Type	BOOLEAN

##### ***Entry Description***

Sub-Index	0h
Access	RW
PDO Mapping	No
Value Range	0 (FALSE) or 1 (TRUE)
Default Value	1 [TRUE]

#### 2.4.117. Object 5555h: Start in Operational Mode

This object allows the unit to start in Operational mode without requiring the presence of a CANopen® Master on the network. It is intended to be used only when running the controller as a stand-alone module. This should always be set FALSE whenever it is connected to a standard master/slave network.

##### ***Object Description***

Index	5555h
Name	Start in Operational Mode
Object Type	VARIABLE
Data Type	BOOLEAN

##### ***Entry Description***

Sub-Index	0h
Access	RW
PDO Mapping	No
Value Range	0 (FALSE) or 1 (TRUE)
Default Value	0 [FALSE]

### 3. Technical Specifications

Specifications are indicative and subject to change. Actual performance will vary depending on the application and operating conditions. Users should satisfy themselves that the product is suitable for use in the intended application.

All our products carry a limited warranty against defects in material and workmanship. Please refer to our Warranty, Application Limitations & Return Materials Process as described on <https://www.axiomatic.com/service/>.

#### 3.1. Inputs

<p>Universal Inputs</p>	<p>All 12 inputs are selectable by the user as:</p> <ul style="list-style-type: none"> <li>• Voltage type</li> <li>• Current type</li> <li>• PWM type</li> <li>• Frequency type</li> <li>• Digital type</li> </ul> <p><u>Voltage Type:</u>            Ranges: 0-5V or 0-10V            Resolution: 1 mV            Accuracy: +/- 0.2%</p> <table border="1" data-bbox="410 758 1487 884"> <thead> <tr> <th colspan="3">Input Impedance</th> </tr> <tr> <th>Range</th> <th>Inputs 1 to 6</th> <th>Inputs 7 to 12</th> </tr> </thead> <tbody> <tr> <td>0-5V</td> <td>&gt;1 GΩ or 10 kΩ pull-down</td> <td rowspan="2">1 MΩ or 10 kΩ pull-down</td> </tr> <tr> <td>0-10V</td> <td>204 kΩ pull-down</td> </tr> </tbody> </table> <p><u>Current Type:</u>            Ranges: 0-20mA or 4-20mA            Resolution: 1μA            Accuracy: +/- 0.2%</p> <table border="1" data-bbox="410 1041 1487 1136"> <thead> <tr> <th colspan="2">Input Impedance</th> </tr> <tr> <th>Inputs 1 to 6</th> <th>Inputs 7 to 12</th> </tr> </thead> <tbody> <tr> <td>249 Ω</td> <td>124 Ω</td> </tr> </tbody> </table> <p><u>PWM Type:</u>            Signal Frequency: 1 Hz to 10 kHz            Duty Cycle: 0 to 100%            Resolution: 0.01%            Accuracy: +/- 1%</p> <p><u>Frequency Type:</u>            Range: 1 Hz to 10 kHz            Resolution: 0.01%            Accuracy: +/-0.1%</p> <p><u>Digital Type:</u>            Amplitude: Up to +Vsupply</p> <table border="1" data-bbox="410 1562 1487 1654"> <thead> <tr> <th>Inputs 1 to 6</th> <th>Inputs 7 to 12</th> </tr> </thead> <tbody> <tr> <td>Active High or Active Low with 10 kΩ pull-up or pull-down</td> <td>1 MΩ impedance or Active High or Active Low with 10 kΩ pull-up or pull-down</td> </tr> </tbody> </table>	Input Impedance			Range	Inputs 1 to 6	Inputs 7 to 12	0-5V	>1 GΩ or 10 kΩ pull-down	1 MΩ or 10 kΩ pull-down	0-10V	204 kΩ pull-down	Input Impedance		Inputs 1 to 6	Inputs 7 to 12	249 Ω	124 Ω	Inputs 1 to 6	Inputs 7 to 12	Active High or Active Low with 10 kΩ pull-up or pull-down	1 MΩ impedance or Active High or Active Low with 10 kΩ pull-up or pull-down
Input Impedance																						
Range	Inputs 1 to 6	Inputs 7 to 12																				
0-5V	>1 GΩ or 10 kΩ pull-down	1 MΩ or 10 kΩ pull-down																				
0-10V	204 kΩ pull-down																					
Input Impedance																						
Inputs 1 to 6	Inputs 7 to 12																					
249 Ω	124 Ω																					
Inputs 1 to 6	Inputs 7 to 12																					
Active High or Active Low with 10 kΩ pull-up or pull-down	1 MΩ impedance or Active High or Active Low with 10 kΩ pull-up or pull-down																					
<p>Resistive Inputs</p>	<p>Inputs 1 to 6 are selectable by the user as Resistive type.            Resolution: 1 Ω            Accuracy: +/- 2%            Range: 30 Ω to 250 kΩ</p>																					
<p>All Inputs</p>	<p>12-bit Analog to Digital            Protected against shorts to GND or +Vsupply            All inputs are sampled every 1 ms.</p>																					



### 3.2. Outputs

All Outputs	<p>12 independent outputs are user selectable as:</p> <ul style="list-style-type: none"> <li>• Proportional voltage</li> <li>• Proportional current</li> <li>• PWM</li> <li>• On/off digital</li> <li>• Hotshot digital</li> </ul> <p>Half-bridge output, current sensing, grounded load            High side sourcing up to 2.5 A (but the total consumption must not exceed 20 A)            High frequency drive</p> <p><u>Proportional Voltage:</u>            Resolution: 100 mV            Accuracy: +/- 5%</p> <p><u>Current Type:</u>            Resolution: 1 mA            Accuracy: +/- 1%</p> <p><u>PWM:</u>            Resolution: 0.1%            Accuracy: +/- 0.1%</p> <p><u>On/Off Digital:</u>            Sourcing from power supply or output off            Load at supply voltage must not draw more than 2.5A.</p> <p><u>Hotshot Digital:</u>            Resolution: 1 mA            Accuracy: +/- 1%</p>
Protection	<p>Overcurrent protection provided            Short circuit protection in hardware</p>

### 3.3. Power Supply

Power Supply Input	<p>12 or 24 VDC nominal (8 to 36 VDC power supply range)</p> <p>The maximum total current draw permitted on the power supply input pins at any given time is 20 A @ 24 VDC. The total current draw is a combination of quiescent current and current draw from all the outputs.</p>
Quiescent Current	<p>133 mA @ 12 VDC; 73 mA @ 24 VDC</p>
Protection	<p>Surge and transient protection provided            Reverse polarity protection up to 60 VDC            Undervoltage hardware shutdown at 4.5 VDC</p>

### 3.4. General Specifications

Microcontroller	STM32H747BIT6, 32-bit, 2 MB flash memory, 1 MB RAM																										
Communication	1 CANopen® port Supported baud-rates: 10 kbit/s, 20 kbit/s, 50 kbit/s, 125 kbit/s, 250 kbit/s, 500 kbit/s, 800 kbit/s, and 1 Mbit/s																										
Control Logic	Here is an overview of the function blocks, including TPDO/RPDO for communications, and diagnostic information. For details, refer to the user manual.																										
	<table border="1"> <thead> <tr> <th>Function Block or Feature</th> <th>Comment</th> </tr> </thead> <tbody> <tr> <td>CANopen RPDOs</td> <td>7 PDOs, 4 Mappable subindexes per PDO</td> </tr> <tr> <td>CANopen TPDOs</td> <td>7 PDOs, 4 Mappable subindexes per PDO</td> </tr> <tr> <td>Conditional Logic</td> <td>10 blocks</td> </tr> <tr> <td>Constant Data</td> <td>15 data points</td> </tr> <tr> <td>Lookup Table</td> <td>9 blocks</td> </tr> <tr> <td>Math</td> <td>6 blocks</td> </tr> <tr> <td>PID Control</td> <td>12 blocks</td> </tr> <tr> <td>Programmable Logic</td> <td>3 blocks</td> </tr> <tr> <td>Set Reset Latch</td> <td>5 blocks</td> </tr> <tr> <td>Input Diagnostics</td> <td>Over &amp; Under Thresholds for each Input</td> </tr> <tr> <td>Output Diagnostics</td> <td>Open &amp; Short Circuit Detection for each Output</td> </tr> <tr> <td>Controller Diagnostics</td> <td>Over &amp; under-voltage detection for Power supply Over-temperature detection CANopen BusOff event detection</td> </tr> </tbody> </table>	Function Block or Feature	Comment	CANopen RPDOs	7 PDOs, 4 Mappable subindexes per PDO	CANopen TPDOs	7 PDOs, 4 Mappable subindexes per PDO	Conditional Logic	10 blocks	Constant Data	15 data points	Lookup Table	9 blocks	Math	6 blocks	PID Control	12 blocks	Programmable Logic	3 blocks	Set Reset Latch	5 blocks	Input Diagnostics	Over & Under Thresholds for each Input	Output Diagnostics	Open & Short Circuit Detection for each Output	Controller Diagnostics	Over & under-voltage detection for Power supply Over-temperature detection CANopen BusOff event detection
	Function Block or Feature	Comment																									
	CANopen RPDOs	7 PDOs, 4 Mappable subindexes per PDO																									
	CANopen TPDOs	7 PDOs, 4 Mappable subindexes per PDO																									
	Conditional Logic	10 blocks																									
	Constant Data	15 data points																									
	Lookup Table	9 blocks																									
	Math	6 blocks																									
	PID Control	12 blocks																									
	Programmable Logic	3 blocks																									
	Set Reset Latch	5 blocks																									
	Input Diagnostics	Over & Under Thresholds for each Input																									
	Output Diagnostics	Open & Short Circuit Detection for each Output																									
Controller Diagnostics	Over & under-voltage detection for Power supply Over-temperature detection CANopen BusOff event detection																										
Compliance	RoHS																										
Vibration	MIL-STD-202H, method 204, test condition C 10g peak (Sine component)																										
	MIL-STD-202H, method 214A, test condition I/B 7.56 Grms (Random component)																										
Shock	MIL-STD-202H, method 213B, test condition A 50 g peak																										
Operating Conditions	-40°C to 85°C (-40°F to 185°F)																										
Storage Temperature	-50°C to +125°C (-58°F to 257°F)																										
Weight	1.27 lb. (0.58 kg)																										
Protection	IP67, Unit is conformal coated and protected by the enclosure.																										
Enclosure and Dimensions	High Temperature Nylon housing, TE Deutsch P/N: EEC-5X650B 4.03 in x 4.25 in x 1.68 in (102.44 mm x 107.96 mm x 42.67 mm) L x W x H including integral connector Refer to the dimensional drawing.																										
Mounting	For mounting information, refer to the dimensional drawing.																										
	Mounting holes sized for 5/16 inch or M8 bolts. The bolt length will be determined by the end-user's mounting plate thickness. The mounting flange of the controller is 0.83 inches (21 mm) thick. If the module is mounted without an enclosure, it should be mounted to reduce the likelihood of moisture entry. Install the unit with appropriate space available for servicing and for adequate wire harness access (6 inches or 15 cm) and strain relief (12 inches or 30 cm). Wires should be of the appropriate gauge to meet requirements of applicable electrical codes and suit the specifications of the connector.  The module must be mounted in an enclosure in hazardous locations. All field wiring should be suitable for the operating temperature range of the module. All chassis grounding should go to a single ground point designated for the machine and all related equipment.																										
Mating Connectors	Mates with the following TE Deutsch P/Ns. DT06-12SA Plug, DT 12 Way A Key DT06-12SB Plug, DT 12 Way B Key DT06-12SC Plug, DT 12 Way C Key DT06-12SD Plug, DT 12 Way D Key																										
	A set of these mating plugs is available, ordering P/N: <b>AX070123</b> (includes 1 plug DT06-12SA, 1 plug DT06-12SB, 1 plug DT06-12SC, 1 plug DT06-12SD, 4 wedgelocks W12S-P012, 48 contact sockets 0462-201-16141, 15 sealing plugs 114017)																										

#### 4. VERSION HISTORY

---

<b>Version</b>	<b>Date</b>	<b>Author</b>	<b>Modifications</b>
1.0.0	Dec. 18, 2023	Jordan Wilbur	Initial Draft
1.0.1	Oct. 3, 2024	M Ejaz Jordan Wilbur	Marketing review Updated technical specifications, dimensional drawing, and block diagrams in section 1.1
1.0.2	Oct. 9, 2024	M Ejaz	Changed output current rating
1.0.3	Oct. 21, 2024	Jordan Wilbur	Added object 2230 Digital Output Status Added object 2371 AO Feedback Current FV
1.0.4	Oct. 31, 2024	M Ejaz	Changed maximum power input current

## OUR PRODUCTS

AC/DC Power Supplies  
Actuator Controls/Interfaces  
Automotive Ethernet Interfaces  
Battery Chargers  
CAN Controls, Routers, Repeaters  
CAN/WiFi, CAN/Bluetooth, Routers  
Current/Voltage/PWM Converters  
DC/DC Power Converters  
Engine Temperature Scanners  
Ethernet/CAN Converters,  
Gateways, Switches  
Fan Drive Controllers  
Gateways, CAN/Modbus, RS-232  
Gyroscopes, Inclinometers  
Hydraulic Valve Controllers  
Inclinometers, Triaxial  
I/O Controls  
LVDT Signal Converters  
Machine Controls  
Modbus, RS-422, RS-485 Controls  
Motor Controls, Inverters  
Power Supplies, DC/DC, AC/DC  
PWM Signal Converters/Isolators  
Resolver Signal Conditioners  
Service Tools  
Signal Conditioners, Converters  
Strain Gauge CAN Controls  
Surge Suppressors

## OUR COMPANY

Axiomatic provides electronic machine control components to the off-highway, commercial vehicle, electric vehicle, power generator set, material handling, renewable energy and industrial OEM markets. ***We innovate with engineered and off-the-shelf machine controls that add value for our customers.***

## QUALITY DESIGN AND MANUFACTURING

We have an ISO9001:2015 registered design/manufacturing facility in Canada.

## WARRANTY, APPLICATION APPROVALS/LIMITATIONS

Axiomatic Technologies Corporation reserves the right to make corrections, modifications, enhancements, improvements, and other changes to its products and services at any time and to discontinue any product or service without notice. Customers should obtain the latest relevant information before placing orders and should verify that such information is current and complete. Users should satisfy themselves that the product is suitable for use in the intended application. All our products carry a limited warranty against defects in material and workmanship. Please refer to our Warranty, Application Approvals/Limitations and Return Materials Process at <https://www.axiomatic.com/service/>.

## COMPLIANCE

Product compliance details can be found in the product literature and/or on [axiomatic.com](http://axiomatic.com). Any inquiries should be sent to [sales@axiomatic.com](mailto:sales@axiomatic.com).

## SAFE USE

All products should be serviced by Axiomatic. Do not open the product and perform the service yourself.



This product can expose you to chemicals which are known in the State of California, USA to cause cancer and reproductive harm. For more information go to [www.P65Warnings.ca.gov](http://www.P65Warnings.ca.gov).

## SERVICE

All products to be returned to Axiomatic require a Return Materials Authorization Number (RMA#) from [rma@axiomatic.com](mailto:rma@axiomatic.com). Please provide the following information when requesting an RMA number:

- Serial number, part number
- Runtime hours, description of problem
- Wiring set up diagram, application and other comments as needed

## DISPOSAL

Axiomatic products are electronic waste. Please follow your local environmental waste and recycling laws, regulations and policies for safe disposal or recycling of electronic waste.

## CONTACTS

**Axiomatic Technologies Corporation**  
1445 Courtneypark Drive E.  
Mississauga, ON  
CANADA L5T 2E3  
TEL: +1 905 602 9270  
FAX: +1 905 602 9279  
[www.axiomatic.com](http://www.axiomatic.com)  
[sales@axiomatic.com](mailto:sales@axiomatic.com)

**Axiomatic Technologies Oy**  
Höytämöntie 6  
33880 Lempäälä  
FINLAND  
TEL: +358 103 375 750  
[www.axiomatic.com](http://www.axiomatic.com)  
[salesfinland@axiomatic.com](mailto:salesfinland@axiomatic.com)