

TECHNICAL DATASHEET #TDAX021900

8 In, 5 Output Valve Controller

6 Universal Analog Inputs, 1 Digital Input
1 Magnetic Pickup Sensor Input
4-2.5A Proportional or On/Off Outputs
1-2.5A Digital Output
CAN (SAE J1939)

with Axiomatic Electronic Assistant

P/N: AX021900

Features:

- Inputs:
 - 6 universal analog signal inputs (current, voltage, resistive, frequency, digital or PWM)
 - 1 digital input for enable/disable functionality
 - 1 magnetic pickup sensor input (RPM)
- Outputs:
 - 4 proportional or on/off valve drivers up to 2.5 A
 - Open or closed loop (PID) drive is user configurable.
 - 1 digital output up to 2.5A
 - Fully protected
- 1 CAN (SAE J1939) port
- CANopen® module available on request
- PID control logic is user configurable
- Time delays can be programmed using the Look Up Tables.
- Flexible and user programmable functionality for diverse applications using the PC-based **Axiomatic Electronic Assistant** together with an Axiomatic USB-CAN converter
- 12V or 24Vdc nominal
- Rugged IP67 protection for harsh environments
- Vibration compliance for mobile equipment



Applications:

The controller is designed for harsh operating environments.

Typical applications can include:

- Industrial, off-highway and marine applications - control of hydraulic proportional poppet or spool valves
- Closed loop control of hydraulic valves
- Interface with a diesel engine's electronic control module PWM signal to drive accessories
- Transmission controls
- Fan drive controls (on request)
- Vehicle traction control (on request)

Ordering Part Numbers:

SAE J1939 version

Controller: **AX021900**

Accessories:

Mating Plug Kit: **PL-DTM06-12SA-12SB**

Axiomatic Electronic Assistant Configuration KIT, P/Ns: **AX070502, AX070505K, or AX070506K**

Description:

The 8 Input, 5 Output Valve Controller (8i5o) is designed for versatile control of up to four proportional outputs to directly drive coils or other loads. Its flexible circuit design gives the user a wide range of configurable input or output types. The sophisticated control algorithms allow the user to program the controller for a wide range of applications without the need for custom software.

The controller has six fully programmable universal inputs that can be setup to read: voltage; current; resistive; frequency; or digital input signals. For added flexibility, it also has a magnetic sensor circuit that can read AC signals and convert them into a frequency (RPM) pickup. Lastly, there is an eighth digital input that can be used for global enable/disable or overrides of one or all of the outputs.

There are four universal outputs that can be setup to drive: proportional current (up to 2.5A each); hotshot digital current; proportional voltage (up to supply); proportional PWM; or straight on/off digital loads. For applications requiring a fifth digital output, there is also one high-side (sourcing) output for up to a 2.5A digital load.

The 8i5o valve controller is highly programmable and allows the user to configure it for their application. Its sophisticated control algorithms allow for open or closed loop drive of the proportional outputs. It can be operated as either a self-contained control system, driving the outputs directly from the on-board inputs, and/or it can be integrated into a CAN J1939 network of controllers. All I/O and logical function blocks on the unit are inherently independent from one another, but can be programmed to interact in a large number of ways. Refer to the block diagram, Figure 1A, for the hardware features. Figure 1B shows the logical function blocks (software) available on the 8i5o.

The 8i5o has a number of built-in protection features that can shut off the outputs in adverse conditions. They include hardware shutoffs to protect the circuits from being damaged as well as software shutdown features that can be enabled in safety critical systems.

The various function blocks supported by the 8i5o are outlined below. All setpoints are user configurable over the CAN port using the Axiomatic Electronic Assistant and an Axiomatic USB-CAN converter.

SAE J1939 References:

J1939	Recommended Practice for a Serial Control and Communications Vehicle Network, SAE, October 2007
J1939/21	Data Link Layer, SAE, December 2006
J1939/71	Vehicle Application Layer, SAE, January 2009
J1939/73	Application Layer-Diagnostics, SAE, September 2006
J1939/81	Network Management, SAE, May 2003

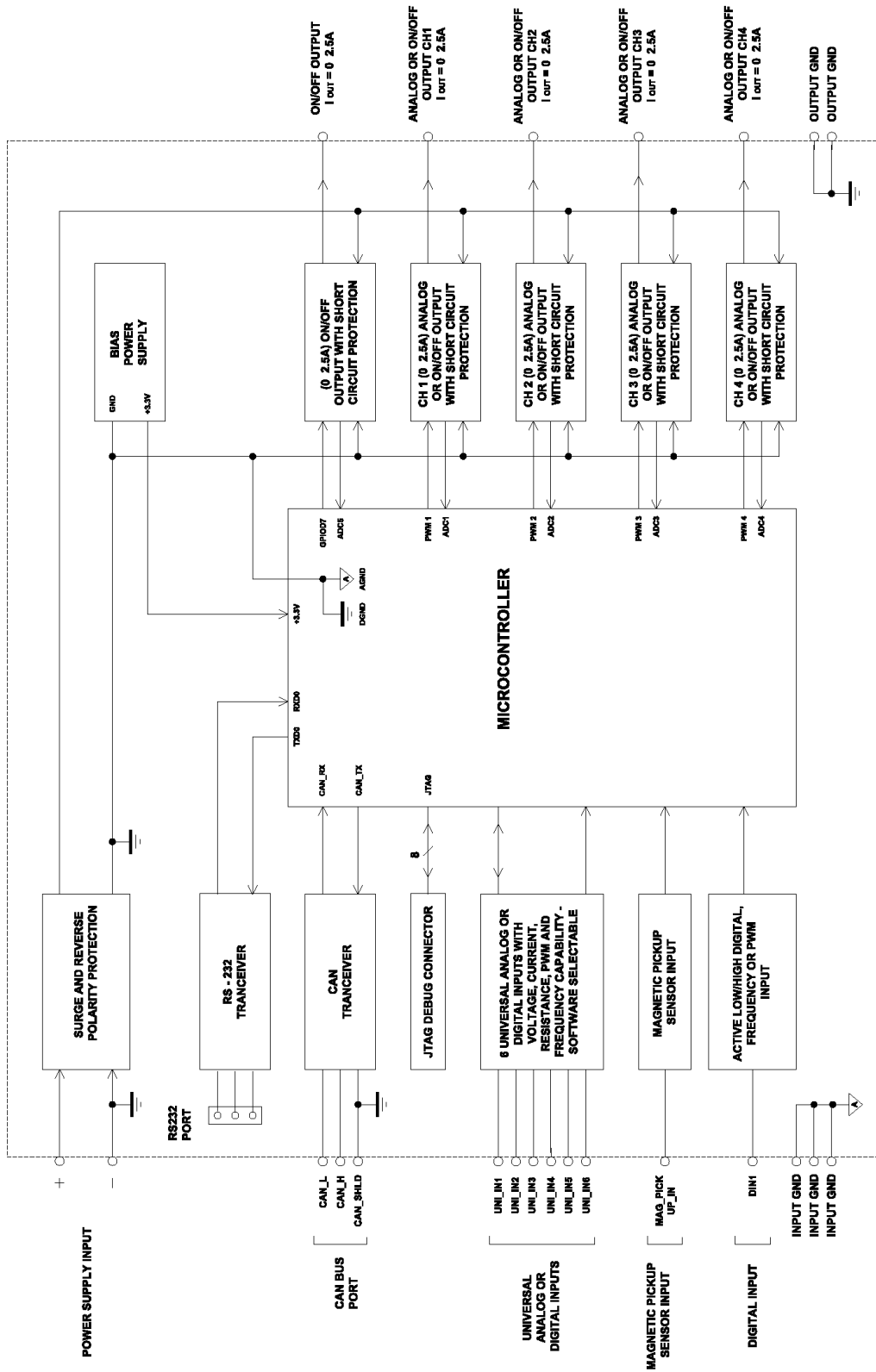

Figure 1A –Hardware Block Diagram

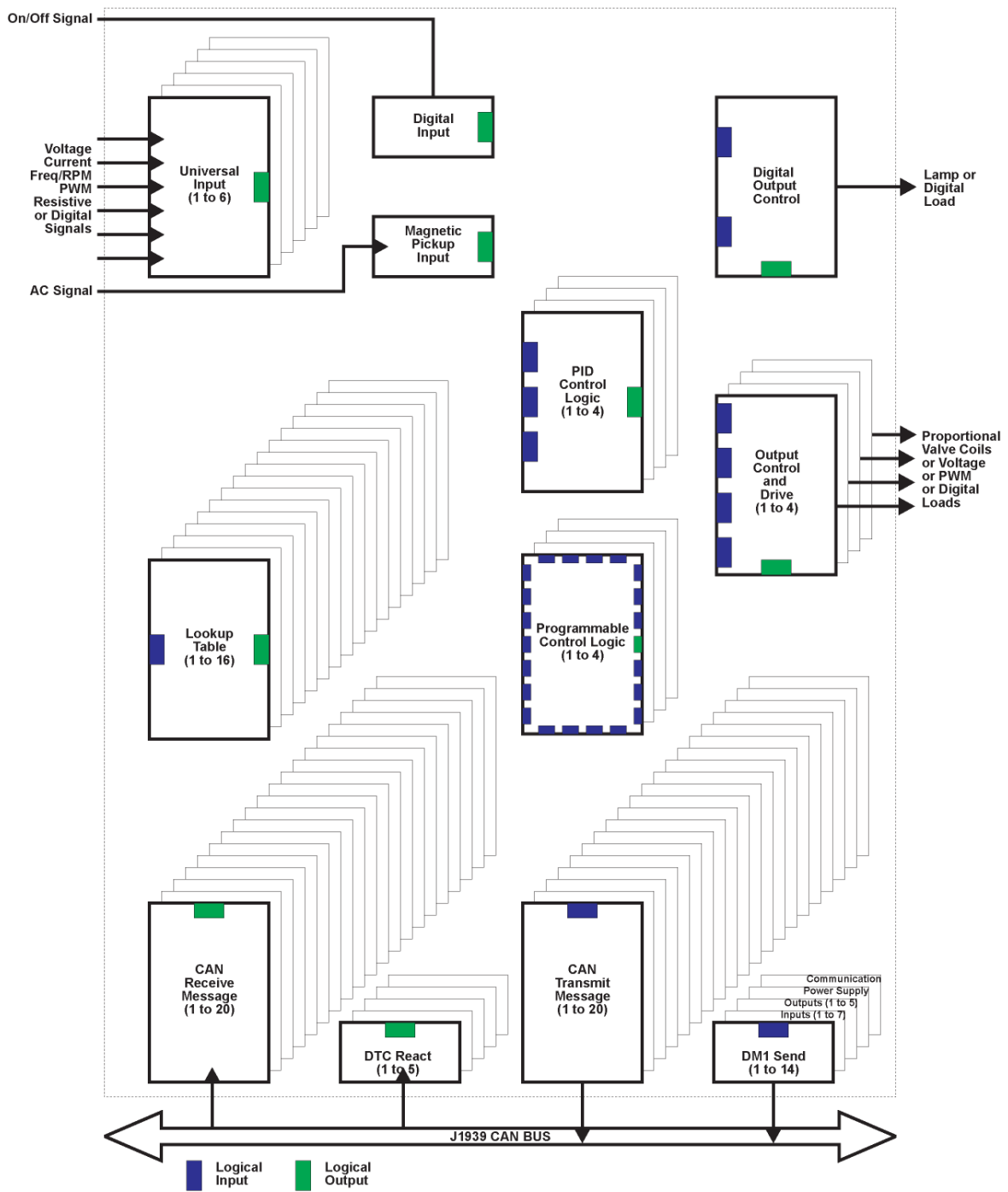

Figure 1B –Logical Functional Block Diagram

Technical Specifications:

Specifications are indicative and subject to change. Actual performance will vary depending on the application and operating conditions. Users should satisfy themselves that the product is suitable for use in the intended application. All our products carry a limited warranty against defects in material and workmanship. Please refer to our Warranty, Application Approvals/Limitations and Return Materials Process as described on <https://www.axiomatic.com/service/>.

Inputs

Power Supply Input - Nominal	12V or 24Vdc nominal (9...60 Vdc power supply range)
Protection	Reverse polarity protection is provided. Surge protection up to 75VDC is provided. Under-voltage shutdown protection of 7.5VDC is provided. Over-voltage shutdown protection is provided.
CAN	SAE J1939 Commands
Input Grounds	3 GND connections are provided.
RPM Input	1 Magnetic Pickup Sensor Input Range: 0.5 Hz to 10 kHz 100mV to 100V RMS
Digital Input	1 digital input User selectable as: <ul style="list-style-type: none"> • Enable/Disable • Active High/Active Low Configurable 10kOhm pullup or pulldown resistor Debouncing provided at 1 ms resolution
Universal Signal Inputs	6 universal inputs are provided. Refer to Table 1.0. All input types are user selectable using the Axiomatic EA as: <ul style="list-style-type: none"> • Voltage • Current • Resistive • Frequency • RPM • PWM • or Digital Inputs are sampled every 1 msec. Protected against shorts to GND or +Vcc

Table 1.0 – Universal Input – User Selectable Parameters	
Analog Input Functions	Voltage Input, Current Input or Resistive Input 12-bit Analog to Digital
Voltage Input	1 mV resolution, accuracy +/-1% error 0-1V (1 MΩ impedance) 0-2.5V (1MΩ impedance) 0-5V (150 KΩ impedance) 0-10V (133 KΩ impedance)
Current Input	1μA resolution, accuracy +/-2% error Current sense resistor 124 Ω 0-20 mA 4-20 mA
Resistive Input	1 Ω resolution, accuracy +/-1% error Self-calibrating for a range of 30Ω to 250 kΩ
Digital Input Functions	Discrete Input, PWM Input, Frequency Input 15-bit Timer
PWM Input	0.01% resolution, accuracy +/-1% error 1 M Ω impedance 0 to 100% Low frequency <1KHz High frequency >100 Hz
Frequency Input	Accuracy +/-1% error 1 MΩ impedance 0.5 Hz to 50 kHz range: 0.01 Hz resolution 10 Hz to 1kHz range: 0.1 Hz resolution 100 Hz to 10 kHz range: 1 Hz resolution
Digital Input	1 MΩ impedance Active High Debouncing provided at 1 ms resolution

Outputs

CAN	SAE J1939 Messages
Universal Outputs	<p>Four fully independent software controlled outputs selectable using the Axiomatic EA as:</p> <ul style="list-style-type: none"> • Proportional Current • Hotshot Digital (See Figure 2.) • PWM Duty Cycle • Proportional Voltage • On/Off Digital <p>Half-bridge outputs, current sensing, grounded load. High side sourcing up to 2.5A</p> <p>Current Outputs: 1mA resolution, accuracy +/- 2% error Software controlled PID current, not accessible to user Fully configurable dither from 50 to 400Hz. High frequency drive at 25kHz</p> <p>Voltage Outputs: 0.1V resolution, accuracy +/- 5% error Average output based on unit power supply High frequency drive at 25kHz</p> <p>PWM Outputs: 0.1% resolution, accuracy +/- 0.1% error Configurable frequency ONLY if no voltage or current output types are used.</p> <p>Digital On/Off: Load at supply voltage must not draw more than 2.5A.</p>
Digital Output	<p>High side sourcing up to 2.5A, grounded load Can be used to drive a diagnostic lamp Works with inductive or resistive loads</p>
Output GND	2 GND connections are provided.
Protection	Fully protected against short circuit to ground and short circuit to power supply rail. Unit will fail safe in the case of a short circuit condition, self-recovering when the short is removed.

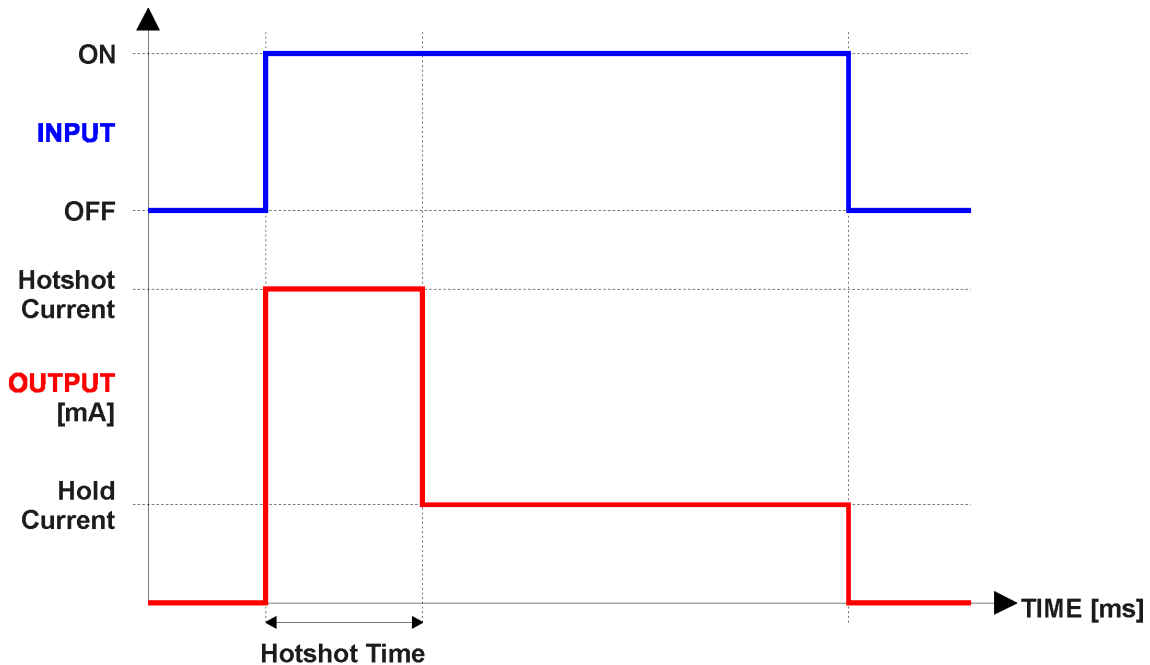

Figure 2 – Hotshot Digital Output (User selectable)

General Specifications

Microprocessor	DSP56F8366
Control Logic	User programmable functionality using the Axiomatic Electronic Assistant. Default control logic is shown in Figure 4. For PID control, refer to Figure 5.
Communications	1 CAN port (SAE J1939) CANopen® is available on request.
RS-232	1 RS-232 port interfaces to a serial port (i.e. COM1) on a PC (115200 Baud Rate, Flow Control) Not available through the connector Connect the RS-232 port from the controller to a PC with Tera Term (Pro) freeware. The user can use the RS-232 port for diagnostics or testing. Changing setpoints is not possible through RS-232. The CAN port and the Axiomatic Electronic Assistant must be used to configure the motor controller. For further details refer to Section 5. NB. Tera Term (Pro) is freeware and is downloadable from http://hp.vector.co.jp/authors/VA002416/teraterm.html .
User Interface	The Axiomatic Electronic Assistant for <i>Windows</i> operating systems. It comes with a royalty-free license for use. Refer to Figure 3. The Axiomatic Electronic Assistant requires an Axiomatic USB-CAN converter to link the device's CAN port to a <i>Windows</i> -based PC. P/N: AX070502 , a Axiomatic Configuration KIT, includes the following. USB-CAN Converter P/N: AX070501 1 ft. (0.3 m) USB Cable P/N: CBL-USB-AB-MM-1.5 12 in. (30 cm) CAN Cable with female DB-9 P/N: CAB-AX070501 AX070502IN CD P/N: CD-AX070502, includes: Axiomatic Electronic Assistant software; Axiomatic EA & USB-CAN User Manual UMAX07050X; USB-CAN drivers & documentation; CAN Assistant (Scope and Visual) software & documentation; and the SDK Software Development Kit.
Diagnostics	Each input and output channel can be configured to send diagnostic messages to the CAN network if the I/O goes out of range. Diagnostic data is stored in a non-volatile log.
Additional Fault Feedback	There are several types of faults that the controller will detect and provide a response: unit power supply under-voltage and over-voltage, and lost communication. They can be sent to the CAN bus.

Set up of SAE J1939 Controller on a CAN Network:

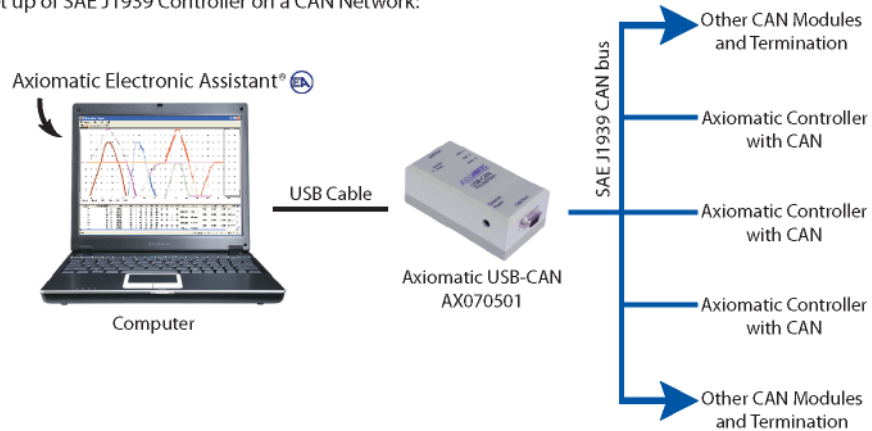

Figure 3 – Configuration using the Axiomatic EA

Operating Conditions	-40 to 85 °C (-40 to 185 °F)
Weight	0.55 lb. (0.25 kg)
Vibration and Shock Compliance	MIL-STD-202G, Test 204D, 214A and 213B 7.68 Grms (Random) 10 g peak (Sine) 50 g (Shock)
Protection	IP67 rating for the product assembly
Electrical Connections	<p>24-pin receptacle (equivalent TE Deutsch P/N: DTM13-12PA-12PB-R008) Mating plug – equivalent to the TE Deutsch P/Ns: DTM06-12SA and DTM06-12SB, with 2 wedgelocks (WM12S) and 24 contacts (0462-201-20141). 20 AWG wire is recommended for use with contacts 0462-201-20141.</p> <p style="text-align: center;">Key Arrangement B (black)</p>  <p style="text-align: center;">Key Arrangement A (grey)</p> <p style="text-align: center;">FRONT VIEW 24 PIN RECEPTACLE</p> <p>Refer to Table 2.0 for the pin out.</p>
Packaging and Dimensions	<p>High Temperature Nylon PCB Enclosure - (equivalent TE Deutsch P/N: EEC-325X4B) 4.62 x 5.24 x 1.43 inches 117.42 x 133.09 x 36.36 mm (W x L x H excluding mating plugs)</p>  <p style="text-align: center;">HOUSING DIMENSIONS Housing Material: High Temperature Nylon (Black)</p> <p style="text-align: center;">3D VIEW Housing with 24 Pin Receptacle</p>  <p style="text-align: center;">FRONT VIEW 24-PIN RECEPTACLE (NOT TO SCALE)</p>  <p style="text-align: center;">PCB Enclosure Deutsch IPD P/N</p> <p style="text-align: center;">Mounting Holes: Ø 0.29 [7.40] through 2 pl for 0.25 [6.00] fastener</p> <p style="text-align: center;">Mounting flange: 16 mm [0.63 in] thick</p> <p style="text-align: center;">Distance between mounting holes</p> <p style="text-align: center;">Mating Plug Assemblies for 24-pin receptacle: Deutsch IPD P/N: DTM06-12SA and DTM06-12SB with wedgelocks WM12S and contacts (Contact factory for contact specification.)</p> <p style="text-align: right;">Dimensions: inches (mm) excluding mating plug(s)</p>

Table 2.0 – Pin out: AX021900

Grey Connector		Black Connector	
Pin #	Function	Pin #	Function
1	BATT +	1	Analog Input 1
2	Output 1	2	Analog Input 2
3	Output 2	3	Analog Input 3
4	Output 3	4	Analog Input 4
5	Output 4	5	Analog Input 5
6	Output 5	6	Analog Input 6
7	Output 5 GND	7	Digital Input 1
8	Output 4 GND	8	Magnetic Pickup Sensor Input
9	Output 3 GND	9	Magnetic Pickup Sensor GND
10	Output 2 GND	10	Analog GND
11	Output 1 GND	11	Analog GND

Control Logic

Below is shown a simplified block diagram illustrating the default control logic programmed into the 8i50 Valve Controller.

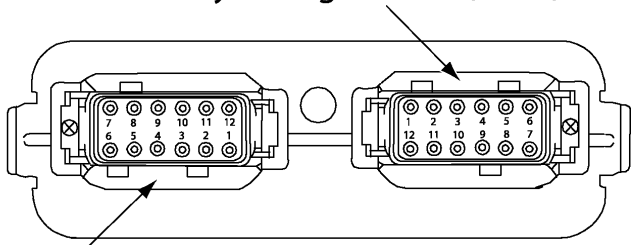
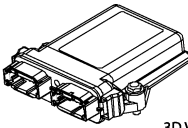
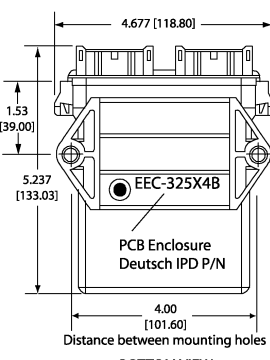
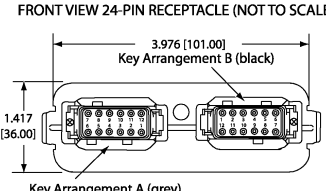
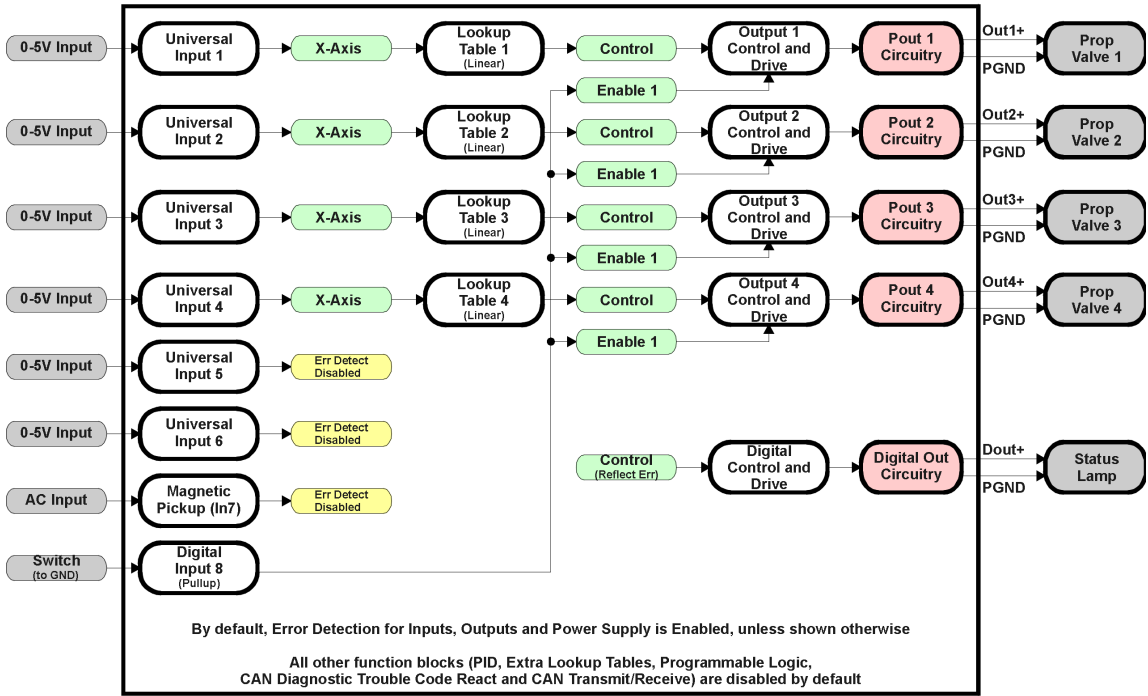

Figure 4 – Default Control Logic

By default, the controller is programmed to be fully self-contained, and does not require a connection to the CAN network to function. All other software function blocks (PID, extra lookup table, programmable logic, CAN diagnostic trouble code react and CAN transmit/receive) are disabled by default.

Technically, there are three types of input function blocks, one for a Universal Input, one for the Magnetic Pickup, and a third for the Digital inputs. In reality, however, the Magnetic Pickup uses the exact same function block as the Universal Input, except that the input type is fixed as a frequency/RPM input.

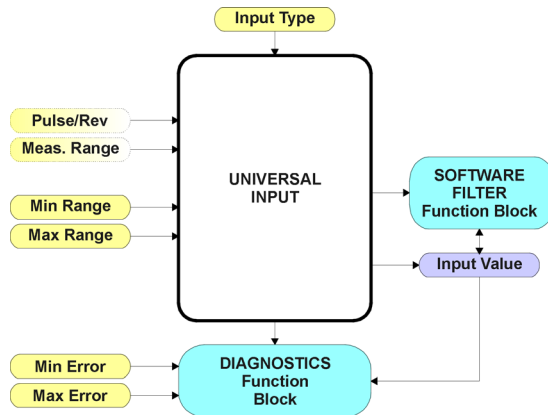

Figure 5 – Universal Input Functional Block

In contrast to the analog input types, the digital input function is very simple, as shown.

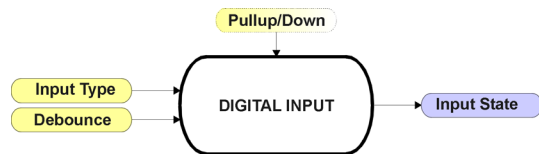

Figure 6 – Digital Input Functional Block

There are three types of output function blocks, one for proportional output drive, the next for proportional output control, and the last for digital output control.

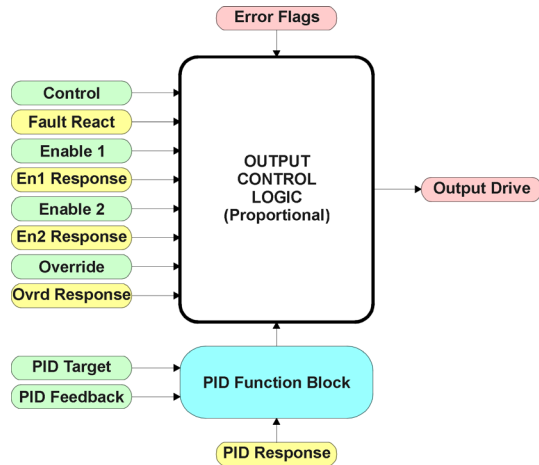

Figure 7 – Output Functional Block

Unlike the proportional outputs, the digital 2.5A output has only a Control and single Enable input.

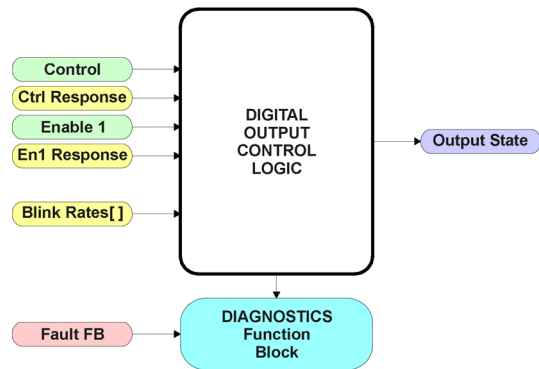

Figure 8 – Digital Output Functional Block

The PID Control function block is associated with proportional output control blocks. When the control logic for an output has been setup for closed-loop control, the output of its PID control function block effectively becomes the command input to the respective output drive. There are several types of closed loop control available including linear relationship between the control input and target settings or setpoint control. Alternatively, 2 proportional outputs can be combined for a push-pull drive in a hydraulic valve control application.

Each system will have to be tuned for the optimum fan response. Response times, overshoots and other variables will have to be decided by the customer using an appropriate PID tuning strategy.

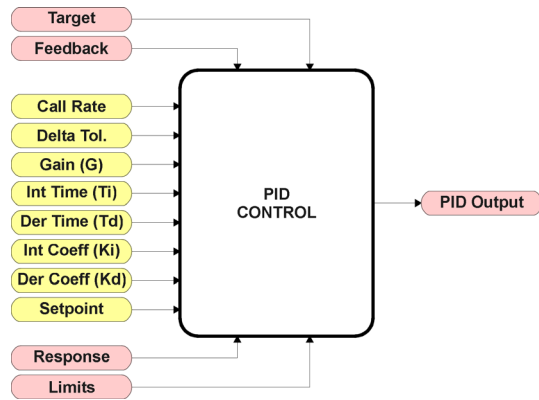

Figure 9 – PID Control Function Block

Lookup Tables are used to give an output response of up to 10 slopes per input. The array size of the Response [], Point X [] and Point Y [] setpoints shown in the block diagram is therefore 11. Note: If more than 10 slopes are required, a Programmable Logic Block can be used to combine up to three tables to get 30 slopes.

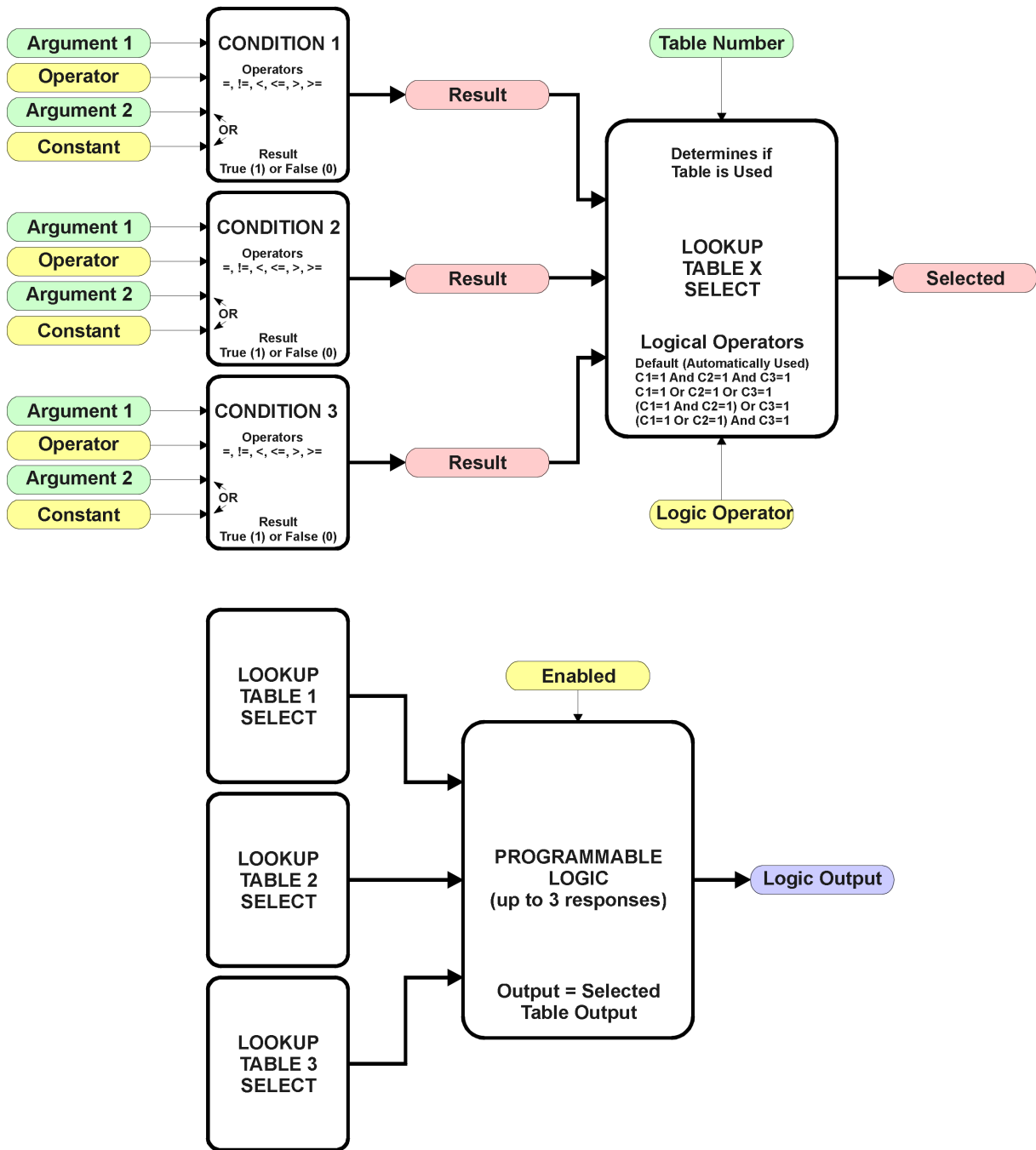

Figure 10 – Programmable Logic Function Block

This function block is obviously the most complicated of them all, but very powerful. The Programmable Logic can be linked to up to three tables, any one of which would be selected only under given conditions. Any three tables (of the available 16) can be associated with the logic, and which ones are used is fully configurable. Refer to the User Manual for sample applications using these functional blocks.

There are several types of diagnostics supported by the 8i5o Valve Controller. Fault detection and reaction is associated with all universal inputs and output drives. In addition to I/O faults, the 8i5o can also detect/react to power supply or lost communication events.

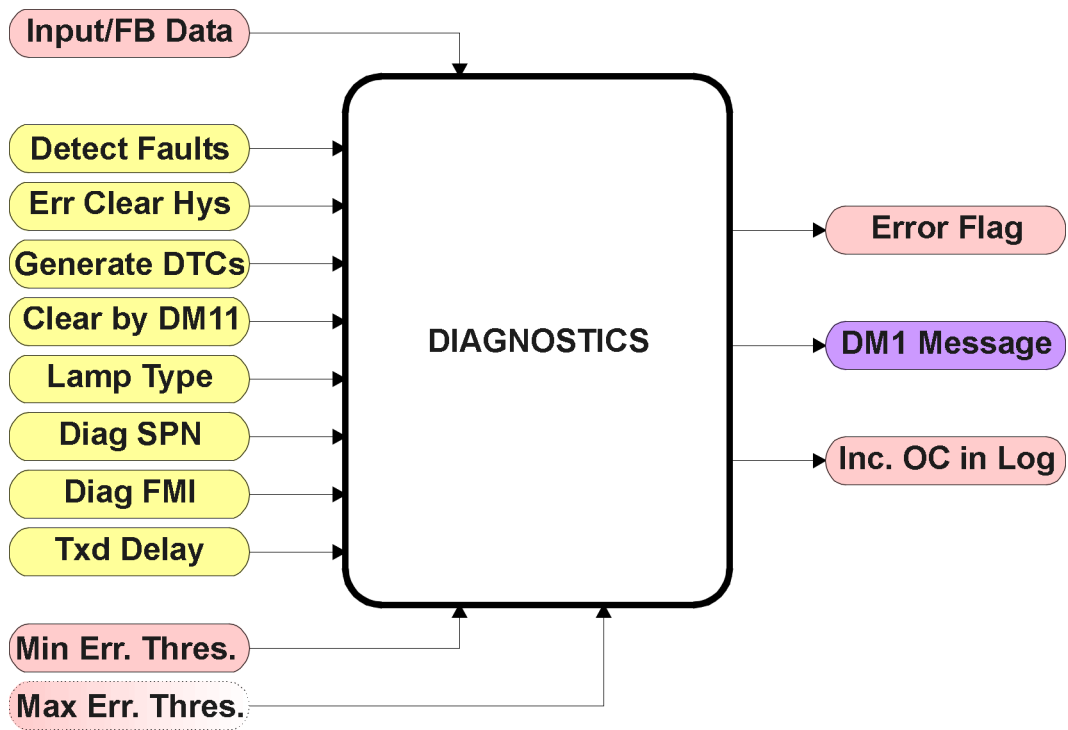

Figure 11 – Diagnostics Function Block

CANopen® is a registered community trademark of CAN in Automation e.V.

Form: TDAX021900-06/12/23